

PANZERI

LA FORMA DELLA LUCE

PANZERI

2021

ARENA ARENA ACOUSTIC

ENZO PANZERI

Anello di luce con spot orientabili o con pannello fonoassorbente integrato. Due tipologie di prodotto combinabili per ottenere al contempo la qualità di un design funzionale e minimale, la flessibilità della luce orientabile e un elevato comfort acustico.

Ring of light with adjustable spots or integrated sound-absorbing panel. Two products that can be combined to obtain at the same time the quality of a functional and minimal design, the flexibility of the adjustable light and a high acoustic comfort.













ARENA

suspension

Ø 98 cm H 5,3 cm - Ø 38 3/8" H 2"
LED 92W 4191lm + 3 x 847lm

suspension

Ø 147 cm H 5,3 cm - Ø 58" H 2"
LED 129W 6287lm + 4 x 847lm

suspension

Ø 194 cm H 5,3 cm - Ø 76 3/8" H 2"
LED 154W 8383lm + 5 x 847lm



ARENA ACOUSTIC

suspension

Ø 98 cm H 5,3 cm - Ø 38 3/8" H 2"
LED 47W 4079lm



BELLA

ENZO PANZERI

Bella è la dematerializzazione del design, un disco di luce dal carattere contemporaneo che offre alte prestazioni in uno spazio minimo. Adatta a composizioni lineari o a cascata, con emissione verso il basso o specchiata verso l'alto per l'illuminazione del soffitto.

Bella is the dematerialization of design, a disc of light with a contemporary look that offers high performance in a minimum space. Suitable for linear or cascade compositions, with direct or indirect upward emission for ceiling lighting.













suspension

Ø 10,1 cm H 14 cm - Ø 4" H 5 ½"
LED 6,5W 388lm

table

Ø 10,1 cm H 31,6 cm - Ø 4" H 12 ¼"
LED 5W 388lm

wall

Ø 10,1 cm W 12,2 cm - Ø 4" W 4 ⅙"
LED 5W 388lm

wall

Ø 10,1 cm W 9,4 cm - Ø 4" W 3 ⅝"
LED 5W 388lm



BELLA VESTITA

MATTEO THUN

Per accogliere Bella in ambienti che richiedono una luce morbida e soffusa, Matteo Thun le ha disegnato un elegante vestito in color avorio. Il tessuto plissettato si aggancia a Bella con una semplice clip che le permette di cambiare look a seconda delle occasioni.

To welcome Bella in environments that require a soft and diffused light, Matteo Thun designed her an elegant dress in ivory color. The pleated fabric simply attaches to Bella with a clip that allows her to change look according to the occasion.

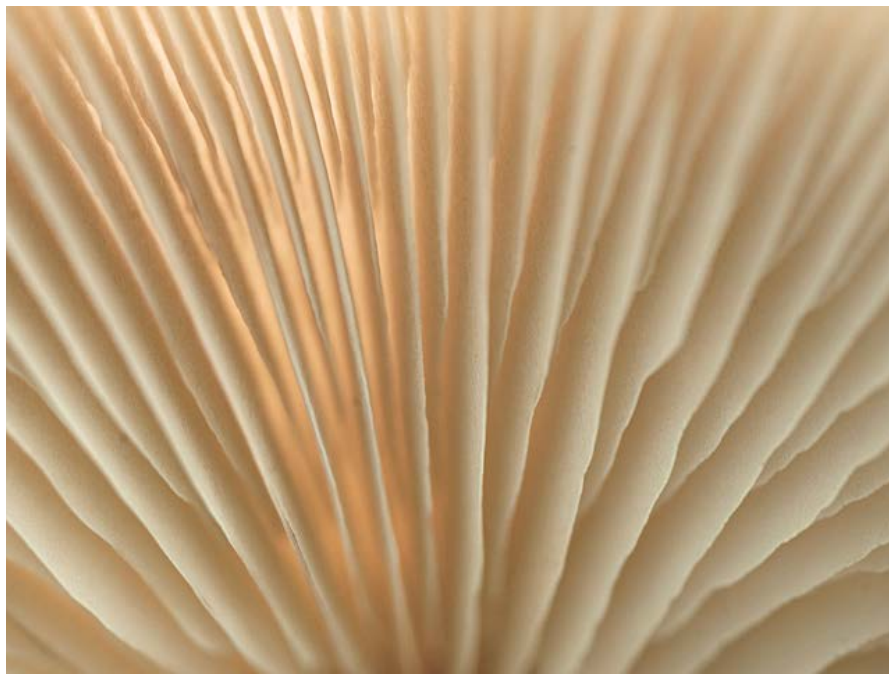



CARL CARL2 SOHO

OFFICINA PANZERI

Spot orientabili dal design sobrio e discreto incontrano esigenze di tecnica e stile.

La flessibilità di posizionamento a soffitto, a incasso o a binario e una vasta gamma di finiture garantiscono un mix tipologico accattivante e allo stesso tempo l'uniformità necessaria per un'elevata resa estetica.

Adjustable spots with a sober and discreet design meet the needs of technique and style. The flexibility of recessed, track or ceiling mounting and a wide range of finishes guarantee an attractive product mix and at the same time the uniformity necessary for a high aesthetic result.









CARL
semirecessed
Ø 5,3 cm H 7,5 cm - Ø 2" H 3"
LED 12W 960lm

semirecessed
Ø 3,6 cm H 7,1 cm - Ø 1 3/8" H 2 7/8"
LED 6,5W 425lm

semirecessed
Ø 5,3 cm H 9,5 cm - L 13" H 3 3/4"
LED 18W 1252lm



CARL2
ceiling
L 33 cm W 7 cm H 11,6 cm - L 13" W 2 3/4" H 4 1/2"
LED 43W 2 x 1252lm







SOHO S 15
track suspension
Ø 5,2 cm H 16,7 cm - Ø 2" H 6 4/8"
LED 18W 1705lm



SOHO 5
track spot
Ø 3,6 cm H 5 cm - Ø 1 3/8" H 2"
LED 6W 463lm



SOHO 10
track spot
Ø 5,3 cm H 7,5 cm - Ø 2" H 3"
LED 18W 1252lm



SOHO 20
track spot
Ø 5,3 cm H 9,5 cm - Ø 2" H 3 3/4"
LED 26W 2025lm



SOHO LINE
track line
L 60 cm W 1,4 cm - L 23 2/3" W 5/8"
LED 12W 740lm

track line
L 90 cm W 1,4 cm - L 35 1/2" W 5/8"
LED 19W 1244lm



CARMEN

CARMEN FERRARA

Conformare la luce alle proprie emozioni è l'idea che sottende il design di Carmen. I bracci ruotano meccanicamente e la lampada assume nuove forme, si estende o compatta. La luce diventa la risposta ad un gesto, la riflessione di un design sempre personalizzabile.

Conforming the light to one's emotions is the idea that underlies Carmen's design. The arms rotate mechanically and the lamp takes on new shapes, extends or compacts. Light becomes the answer to a gesture, the reflection of a design that is always customizable.









ceiling

L 222 cm H 20 cm - L 87 ½" H 7 ⅞"
LED 56W 5420lm

ceiling

L 151 cm H 20 cm - L 59 ½" H 7 ⅞"
LED 28,5W 2519lm

wall

L 26 cm H 61 cm - L 10 ¼" H 24"
LED 13W 1025lm

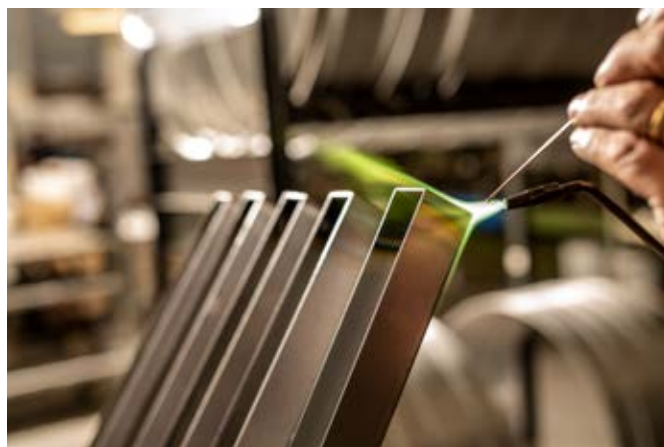

FIREFLY IN THE SKY

MATTEO THUN

Spostare la luce liberamente, con la stessa leggerezza delle lucciole in volo nelle notti d'estate. Firefly in the sky ha una testa ricaricabile, con aggancio magnetico e regolazione touch dell'intensità della luce. Disponibili sistema antitaccheggio e vassoio per la ricarica simultanea fino a 10 prodotti.

Move the light freely, with the same lightness of fireflies on summer nights. Firefly in the sky has a rechargeable head, with magnetic coupling and touch adjustment of the light intensity. Anti-theft system and tray for simultaneously charging up to 10 products.









table

Ø 12,4 cm H 26,5 cm - Ø 4 5/8" H 10 1/2"
LED 2W 134lm



GINEVRA

CHRISTIAN BURTOLF

Studiata per unire in sé la tecnicità di un'emissione di luce controllata e l'estetica di un design ricercato. Lo schermo microprismato arretrato e l'abbinamento di due finiture interno/esterno offrono una perfetta integrazione tra funzionalità e stile.

Designed to combine the technicality of a controlled light emission and the aesthetics of a sophisticated design. The recessed microprismatic screen and the combination of internal/external finishes offer a perfect integration between functionality and style.









suspension
Ø 53 cm H 11 cm - Ø 20 7/8" H 4 1/2"
LED 36W 2916lm



suspension
Ø 80 cm H 14 cm - Ø 31 1/2" H 5 1/2"
LED 82W 7782lm

ceiling
Ø 53 cm H 11 cm - Ø 20 7/8" H 4 1/2"
LED 25W 1877lm

ceiling
Ø 80 cm H 14 cm - Ø 31 1/2" H 5 1/2"
LED 71W 6743lm





CULTURA & CULTURE

arch. Maurizio De Caro

Director for the culture of project and research for architecture and design - Panzeri

La luce ha sempre cercato di illuminare ogni gesto creativo, dall'arte ai monumenti. Il principio generatore di ogni progetto presuppone una presenza significativa e produttiva di ogni azienda che ha a cuore il patrimonio italiano, spesso soggetto a scarsa attenzione e manutenzione.

The light always endeavored to illuminate every creative gesture, from art to monuments. The generating principle of each project implies a relevant and productive presence of every firm that has close to heart the Italian heritage, often subject to insufficient attention and maintenance.

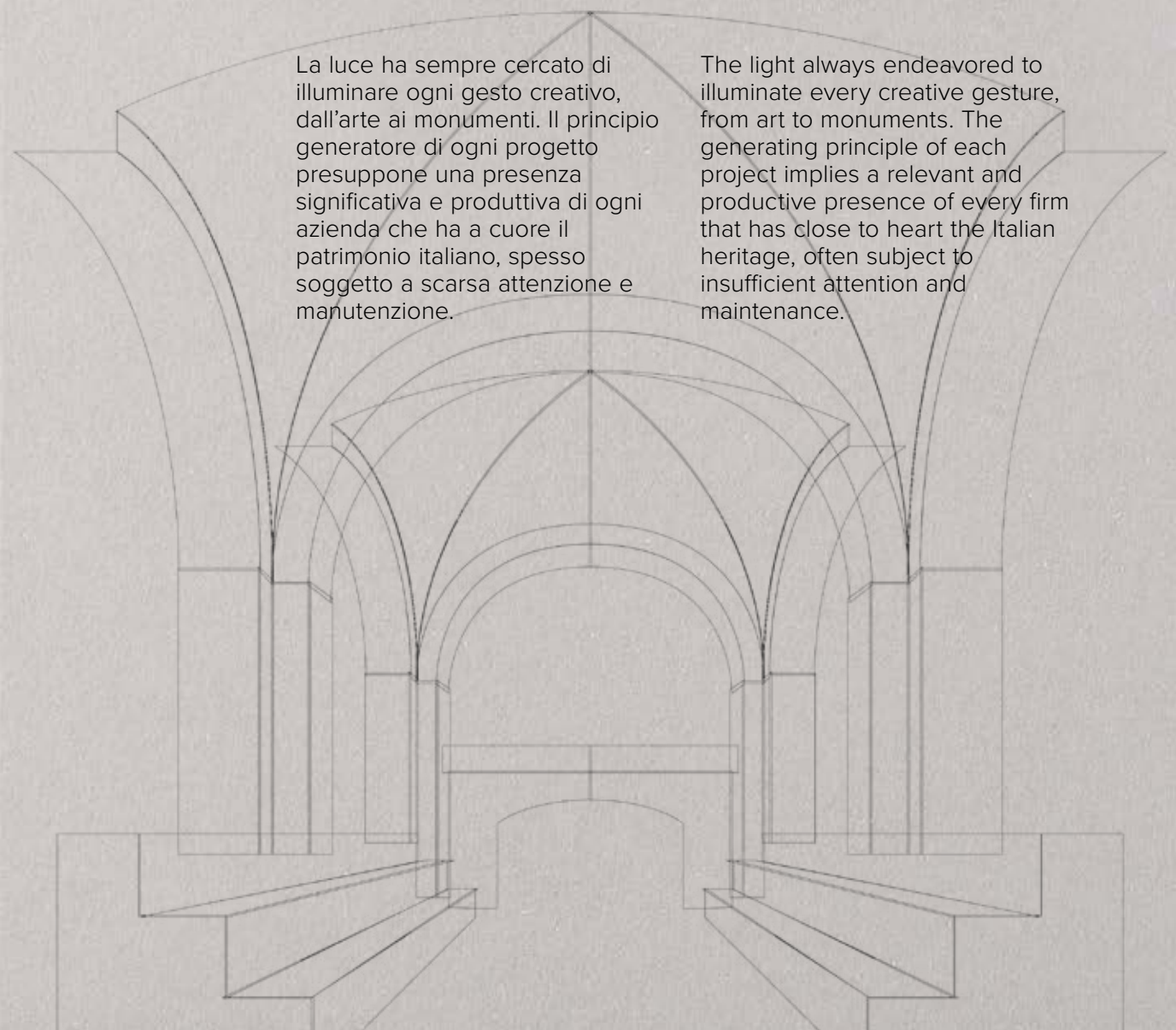

CERTOSA E MUSEO DI SAN MARTINO – NAPOLI

Project: Ludovica Giusti Campi Architetti

Photos: Mario Ferrara

Si ringrazia la Direzione Regionale Musei Campania-
Certosa e Museo di San Martino - Napoli



Panzeri ha voluto dare un contributo materiale e concettuale intraprendendo una serie di iniziative rivolte alla risoluzione di problemi che gli spazi museali portano con sé, modificando antichi percorsi culturali e razionalizzando con i propri prodotti ambienti espositivi in varie parti del paese.

Panzeri decided to give a material and conceptual contribution undertaking a series of initiative addressed to the resolution of recurring problems in museums, updating old cultural paths and rationalizing with its own products exhibiting spaces in several parts of Italy.



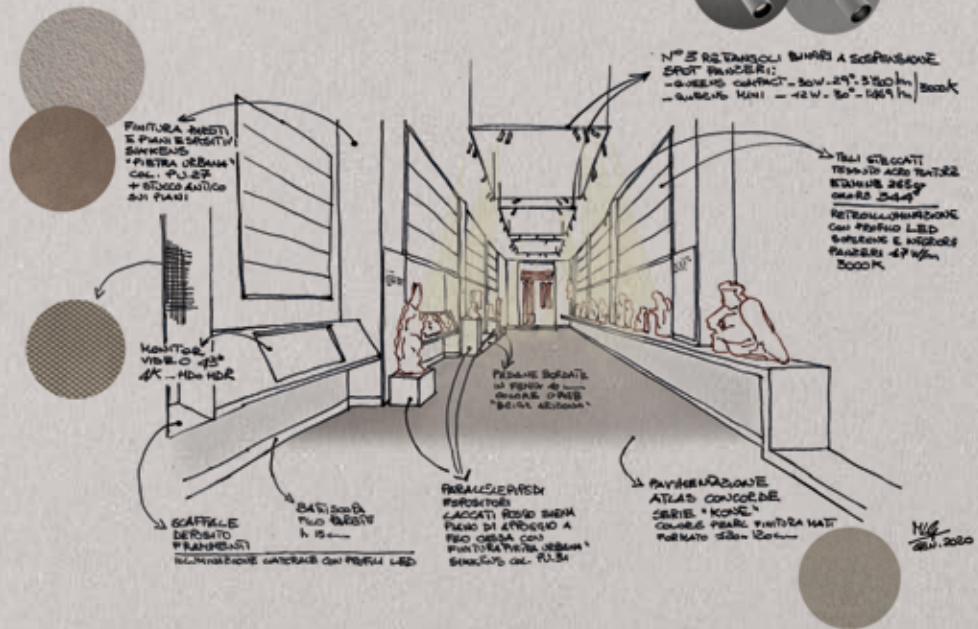

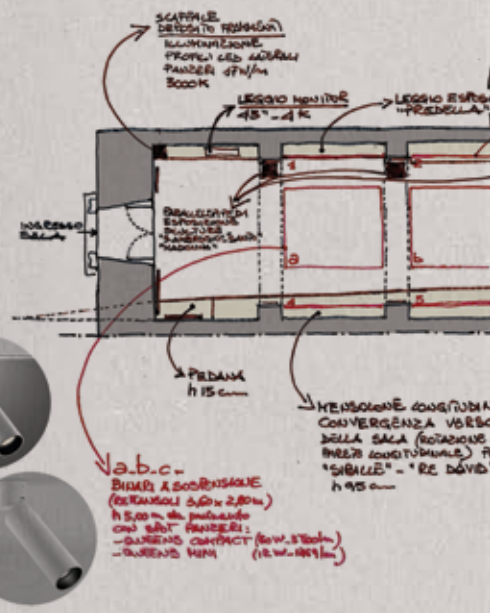

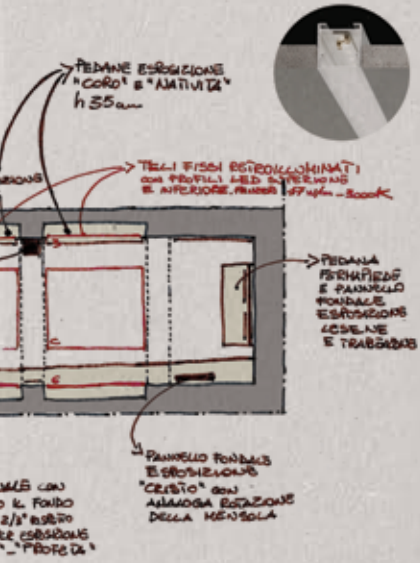

HLG
 GEN. 2020



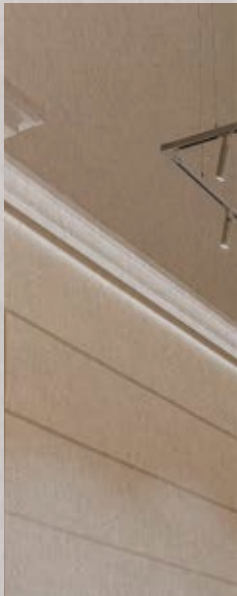
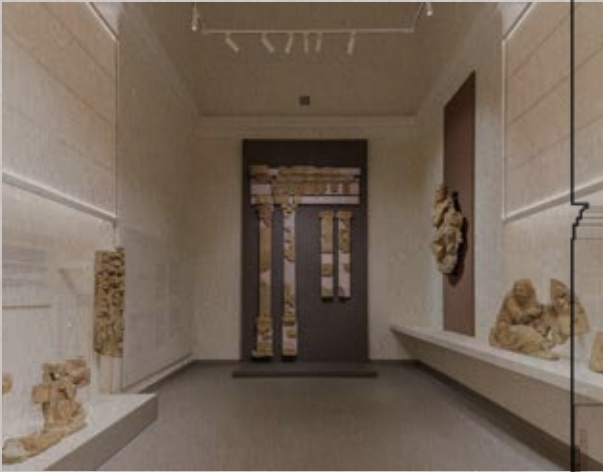

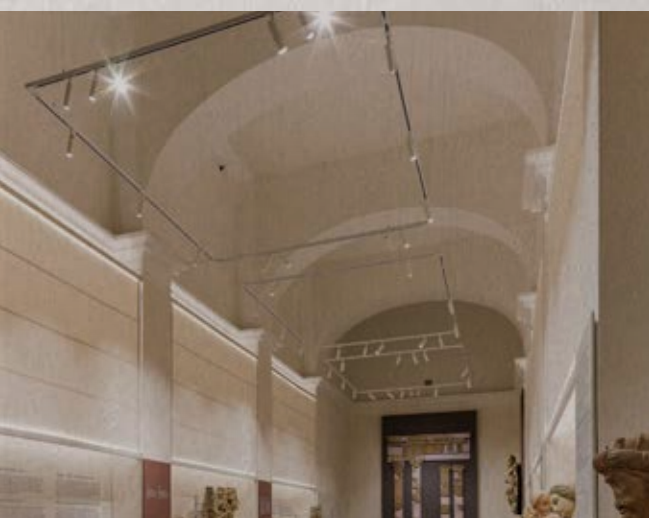
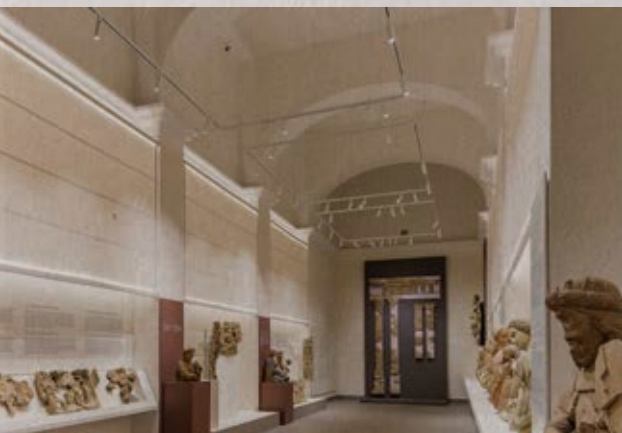
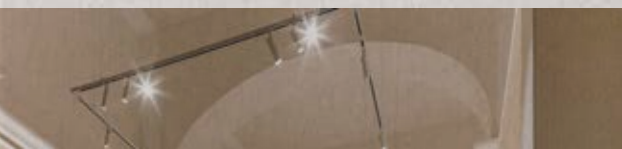

In effetti "Panzeri per la Cultura" è un programma interno all'azienda che si occupa di sperimentare queste nuove opportunità di dialogo con gli Architetti e le Istituzioni per arrivare ad una significativa presenza professionale e progettuale, in questo ambito trainante del nostro paese.

Actually "Panzeri for Culture" is an internal program that aims at experimenting such new opportunities of dialogue with architects and institutions in order to achieve a significant presence in the professional and design field of this leading field of our country.



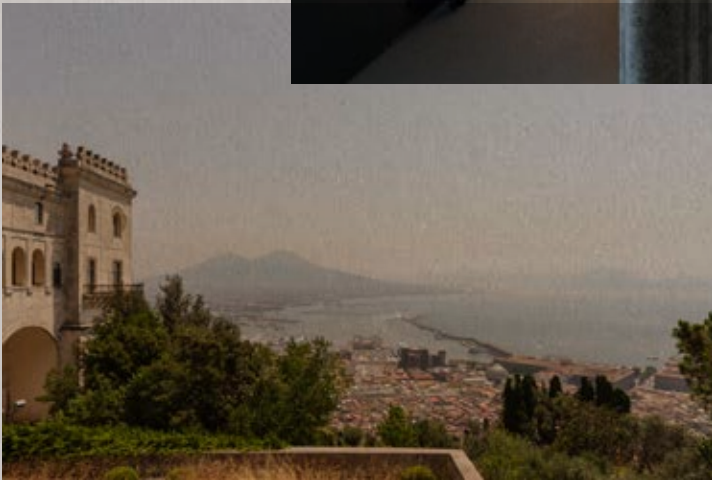
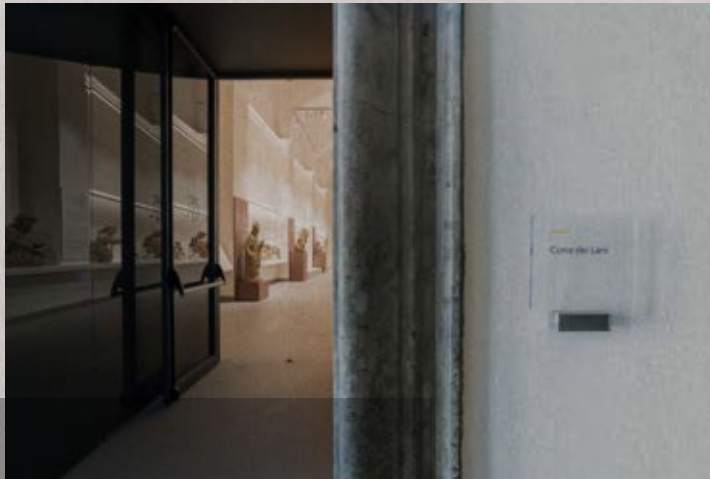

La scelta non è casuale, e non ha subito rallentamenti per le condizioni generali della società, anzi pensiamo che investire in cultura, oggi più che mai, rappresenti un'occasione importante per ogni imprenditore che voglia lasciare un segno non solo per la contemporaneità ma per le generazioni future.



The choice is not accidental, and did not undergo delays for the general conditions of society, on the contrary we believe that investing in culture, today more than ever, represents a unique opportunity for each entrepreneur that strives for leaving a mark not only for the contemporary society but for future generations.

GONIO

STEFANO AIRAGHI

Doppia emissione asimmetrica che consente di illuminare in modo ottimale sia i percorsi che il soffitto. Gonio è una lampada a parete dalla geometria semplice e lineare che attraverso l'impiego di lenti risponde con funzionalità ad una distribuzione orientata in modo preciso.

Double asymmetrical emission that allows you to optimally illuminate both the paths and the ceiling. Gonio is a wall lamp with a simple and linear geometry which, through the use of lenses, responds with functionality to a precisely oriented light distribution.









wall

L 30 cm H 5,6 cm W 14,5 cm - L 11 5/8" H 2 1/8" W 5 5/8"
LED 26W 2592-2496lm

wall

L 58 cm H 5,6 cm W 14,5 cm - L 22 5/8" H 2 1/8" W 5 5/8"
LED 48W 5184-4992lm

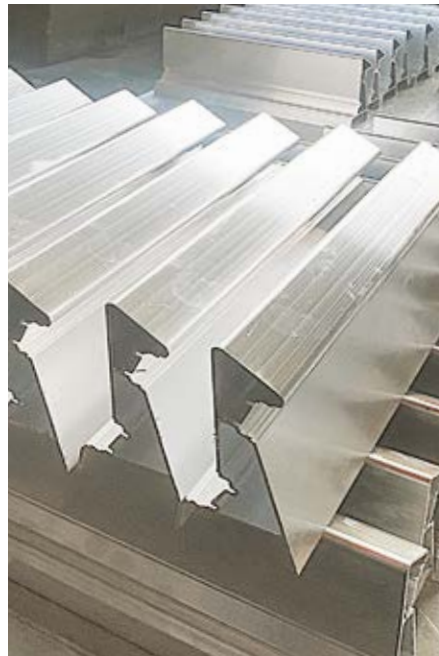



HILOW HILOW LINE

MATTEO THUN

In grado di caratterizzare con infinite possibilità compositive la scenografia di ogni ambiente, installabile in modo libero e intuitivo, per illuminazione diretta o indiretta. Abbinando gli articoli To-be22 è possibile integrare una luce concentrata verso il basso e dare alle composizioni uno sviluppo tridimensionale.

With its countless compositional options, this luminaire adds distinctive appeal to the decor in all contexts. It allows intuitive installation wherever required, for direct or indirect lighting. By combining the To-be22 pendants it is possible to integrate a concentrated light downwards and give the compositions a three-dimensional development.

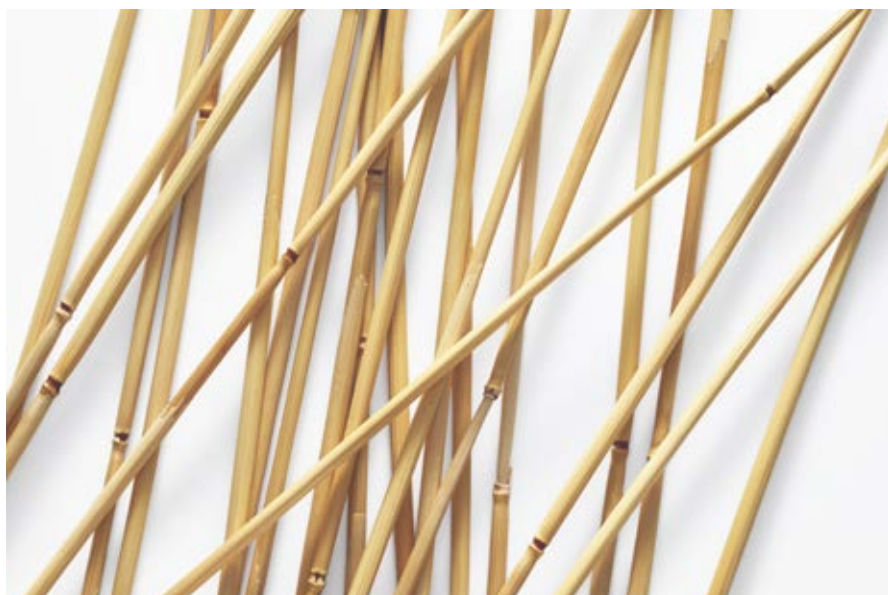



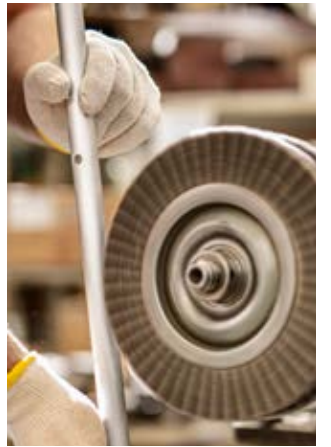



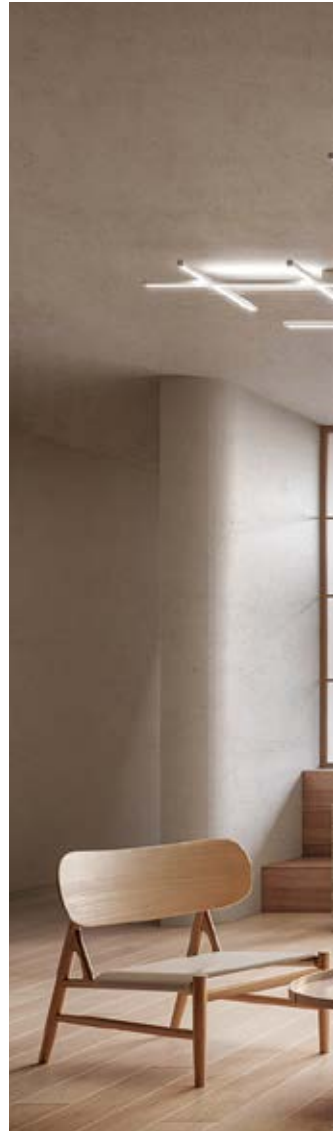
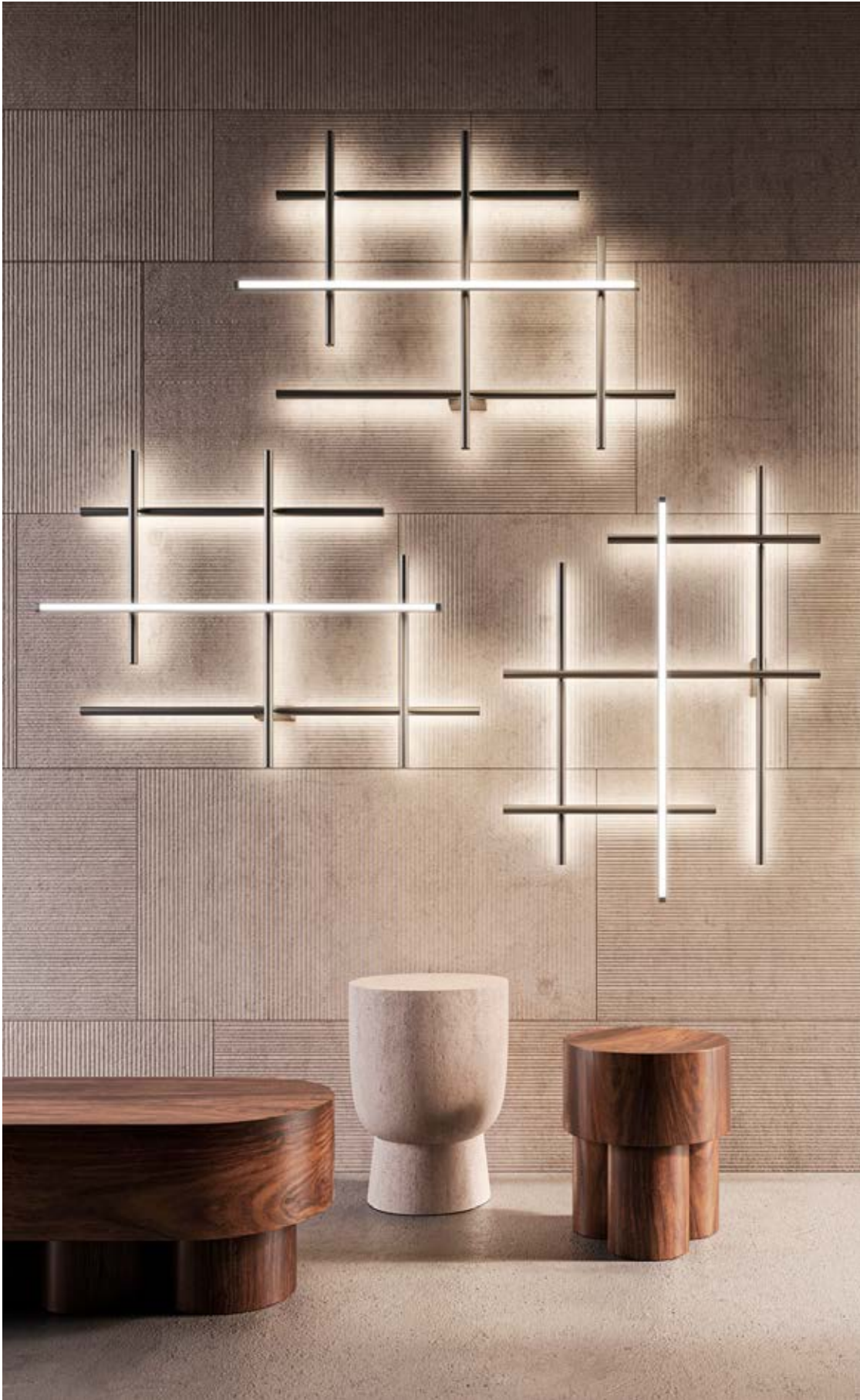



suspension

L 113 cm W 82 cm H 7 cm - L 44 ½" W 32 ⅓" H 2 ¾"
LED 80W 5045lm

ceiling

L 113 cm W 82 cm H 13 cm - L 44 ½" W 32 ⅓" H 5 ⅛"
LED 78W 4602lm

wall

L 113 cm H 82 cm W 13 cm - L 44 ½" H 32 ⅓" W 5 ⅛"
LED 77 W 3812lm









floor

Ø 12 cm H 204 cm - Ø 4 ¾" H 80 ¾"
LED 39W 2242lm

wall

L 4 cm W 8 cm H 100 cm - L 1 ½" W 3 ½" H 39 ¾"
LED 17W 841lm

wall

L 4 cm W 8 cm H 150 cm - L 1 ½" W 3 ½" H 59 ½"
LED 27W 1402lm





JACKIE

ENZO PANZERI

Versatile ed estremamente flessibile nell'orientamento della luce, dietro al design essenziale di Jackie si nascondono sofisticati meccanismi a snodo e a tirante che consentono la regolazione della testa e del braccio con una tenuta straordinariamente salda.

Versatile and extremely flexible in the orientation of the light, behind the essential design of Jackie there are sophisticated joint and tie rod mechanisms that allow the adjustment of the head and the arm with an extraordinarily firm grip.





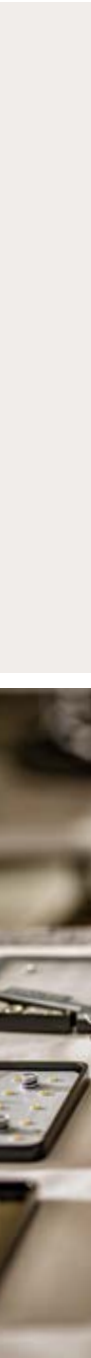



table

W 10,5 L 59 cm H 54 cm - W 4 1/2" L 23 1/4" H 21 3/8"
LED 10W 706lm

floor

W 10,5 L 59 cm H 128 cm - W 4 1/2" L 23 1/4" H 50 3/8"
LED 10W 706lm

wall

W 10,5 L 20 cm H 8,5 cm - W 4 1/2" L 7 7/8" H 3 1/3"
LED 10W 706lm

ceiling spot

W 8,5 L 10,5 cm H 20 cm - W 3 1/2" L 4 1/8" H 7 7/8"
LED 8,5W 820 lm



JAY

OFFICINA PANZERI

Tante funzionalità in un unico oggetto che è insieme luce direzionabile per la lettura, luce soffusa d'ambiente e mensola con presa USB per la ricarica del cellulare e piccoli dispositivi elettronici. Disponibile in due versioni speculari per il posizionamento sul lato sinistro e destro del letto.

Many features in a single object that is together directional light for reading, soft ambient light and shelf with USB socket for charging mobile phones and small electronic devices. Available in two mirrored versions for positioning on the left and on the right side of the bed.





wall

L 33 W 11,5 cm H 11,5 cm - L 13" W 4 1/2" H 4 1/2"
LED 18W 345lm + 405lm



KIPS

ENZO PANZERI

Sono i piccoli dettagli a fare una grande differenza. Kips è una linea di luce di soli 6mm che attraverso la combinazione di elementi curvi e lineari consente di marcare le scelte degli interni e sottolinearne i profili dando un tocco di classe di precisione sartoriale.

It's small details that make a big difference. Kips is a line of light of only 6mm that through the combination of curved and linear elements allows you to mark the choices of the interiors and underline the profiles giving a touch of class of tailoring precision.









profiles

L 500 mm - L 19 2/3"
 L 1000 mm - L 39 1/2"
 L 2000 mm - L 78 1/2"
 L 3000 mm - L 118 1/2"

LED MODULE

1000x6xh12 - 39 3/8"x 1/4"xh 1/2" 10,6W 401lm
 5000x6xh12 - 197"x 1/4"xh 1/2" 10,6W/m 401lm/m



profiles

45° Ø 1033 mm - Ø 40 5/8"
 90° Ø 1033 mm - Ø 40 5/8"
 180° Ø 1033 mm - Ø 40 5/8"

LED MODULE

1000x6xh12 - 39 3/8"x 1/4"xh 1/2" 10,6W 401lm
 5000x6xh12 - 197"x 1/4"xh 1/2" 10,6W/m 401lm/m



LOLA

OFFICINA PANZERI

Con base o a incasso Lola è sinonimo di versatilità: un design adattabile a molteplici applicazioni caratterizzato da linee compatte, fascio luminoso orientabile e ottiche arretrate con snoot di serie che consentono di ridurre l'abbagliamento al minimo.

With base or recessed Lola is synonymous with versatility: a design adaptable to multiple applications characterized by compact lines, adjustable light beam and recessed optics with standard snoot that allow to reduce glare to a minimum.

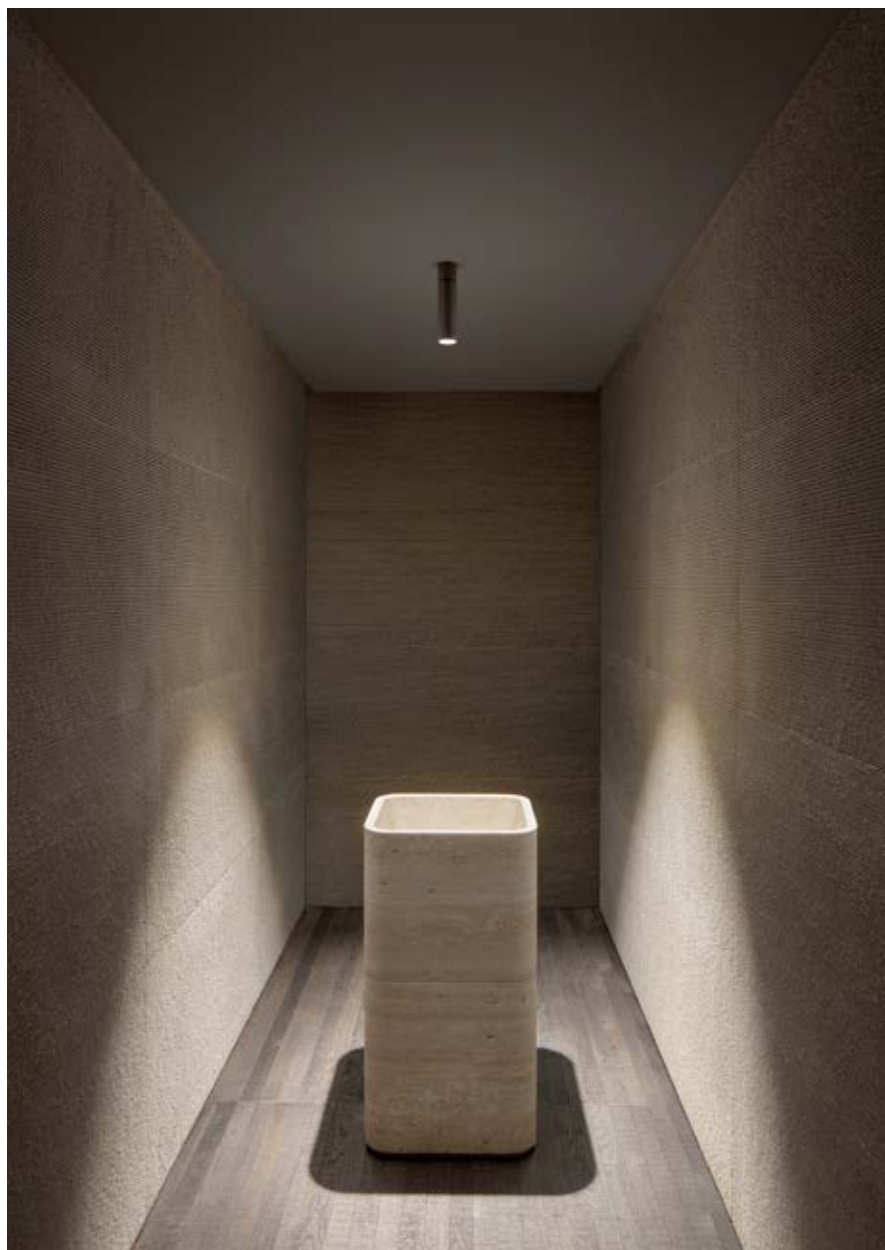



ceiling/wall

Ø 5,2 cm H 20,4 cm - Ø 2" H 8"
LED 9W 972lm

ceiling

Ø 5,2 cm H 20,3 cm - Ø 2" H 8"
LED 18W 1995lm



MANHATTAN

ENZO PANZERI

La luce indiretta emessa dal sistema Manhattan è morbida e avvolgente, ideale in installazioni perimetrali a soffitto con effetto wallwasher delle pareti. Una gamma di accessori consente di seguire la geometria degli ambienti e di tracciare percorsi continui soffitto-parete.

The indirect light emitted by the Manhattan system is soft and relaxing, ideal for perimeter ceiling installations with a wallwasher effect on the walls. A range of accessories allows you to follow the geometry of the rooms and to trace continuous ceiling-wall paths.





profiles

- L 420 mm - L 16 5/8"
- L 920 mm - L 36 1/4"
- L 1920 mm - L 75 3/8"
- L 2920 mm - L 115"

LED MODULE

- 5000 mm - 197" 21,6W/m 3020lm/m
- 5000 mm - 197" 17W/m 1964lm/m
- 5000 mm - 197" 10W/m 1200lm/m



OLIVIA EMMA CLIO

SILVIA POMA

Riprendere l'artigianato di un tempo e riproporlo in chiave contemporanea. Tre forme sinuose in vetro soffiato arricchite dal dettaglio a coste. L'ampia selezione di abbinamenti per le colorazioni della struttura e del vetro le rende adatte all'illuminazione di ambienti sia classici che contemporanei.

Resume the craftsmanship of the past and re-propose it in a contemporary key. Three sinuous shapes in blown glass enriched by the ribbed detail. The wide selection of combinations for the colors of the structure and the glass makes them suitable for lighting both classic and contemporary environments.









OLIVIA
suspension
Ø 13 cm H 27,4 cm - Ø 5 1/8" H 10 1/2"
LED 8W 1050lm



EMMA
suspension
Ø 26 cm H 18,5 cm - Ø 10 1/4" H 7 3/8"
LED 8W 1050lm



CLIO
suspension
Ø 8,5 cm H 31 cm - Ø 3 1/3" H 12 1/8"
LED 8W 1050lm





FILIERA PRODUTTIVA ETICA E SOSTENIBILE

ETHICAL AND SUSTAINABLE
SUPPLY CHAIN

Non è una novità il chiedersi oltre a cosa produrre: come produrre. La dissoluzione della centralità dell'estetica spinge prepotentemente l'imprenditore a scelte nuove, ad un'attenzione per la conoscenza delle nuove opportunità che la tecnologia "dolce" riesce a indicarci, senza dover rinunciare alla qualità finale del prodotto.

It is not new to ask oneself not only what to produce, but also how to produce. The dissolution of the centrality of aesthetics prominently drives the entrepreneur towards new choices, towards an attention to the knowledge of new opportunities that the "sweet" technology can point us to, without compromising on the quality of the final product.

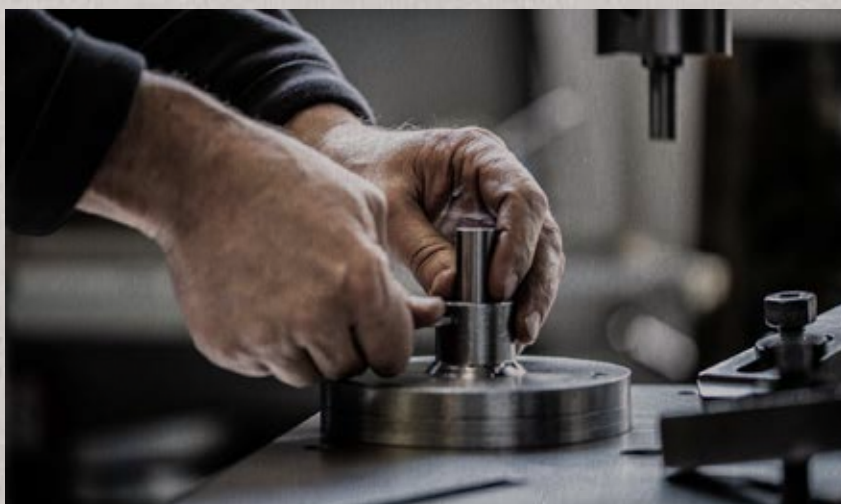

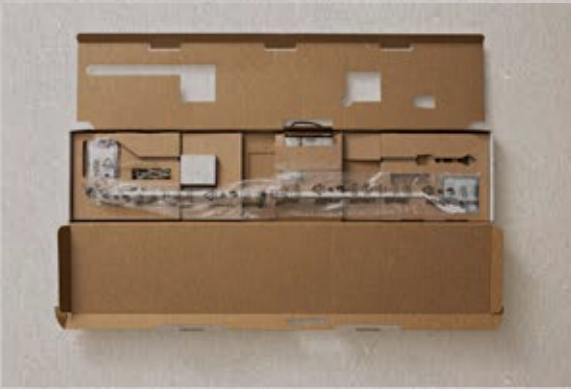



Il concetto di filiera produttiva “etica” presuppone una crescita della sensibilità complessiva che un’azienda come Panzeri ha sempre tenuto in grande considerazione, soprattutto in un campo come quello del “lighting design” dove la componente tecnologica ci appare continuamente in evoluzione, sia per il controllo energetico che per la qualità delle materie e delle componentistiche impiegate.

The concept of “ethical” production chain requires a rise of the overall sensitivity that a firm such as Panzeri always had to take into great consideration, especially in a field such as that of “lighting design” where the technological component appears continuously in evolution, both for the energetic control and the quality of the raw materials and the components utilized.

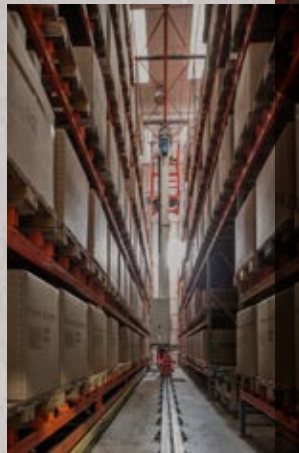



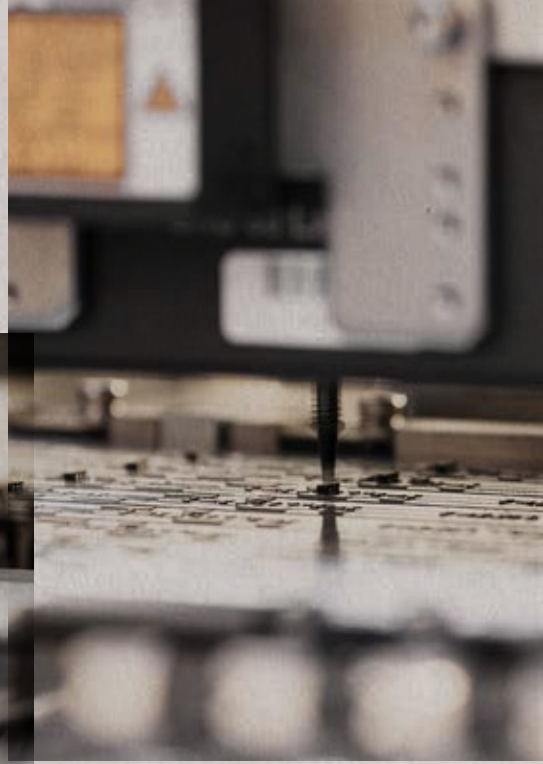



MATERIALI ECOCOMPATIBILI E ATOSSICI

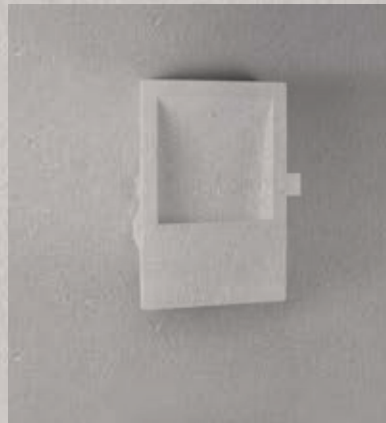

Non è solo una necessità ambientale, per la salvaguardia e la cura del nostro pianeta, ma è il tema della “responsabilità civile” che ogni imprenditore deve tenere nella massima considerazione perché non abbiamo più tempo per sprecare energia, per sprecare la luce, e il ben-essere che questo processo costruttivo determina non è negoziabile.

It is not simply an environmental need, for the safeguard and care of our planet, it is in fact a “civil liability” that each entrepreneur must take into maximum consideration because we have no more time to waste energy, to waste light. And the well-being that this constructive process determines is not negotiable.

Gli errori del passato sono diventati l'insegnamento e la condivisione per un futuro pulito e luminoso, come le nostre lampade.

Mistakes from the past become the teaching and the sharing for a clean and bright future, like our lamps.

arch. Maurizio De Caro



OPUNTIA

FAVARETTO&PARTNERS

Luce che evolve adattandosi agli umori e alle esigenze specifiche. La tecnologia bianco dinamico di Opuntia consente di impostare colorazioni calde o fredde mentre la tecnologia dim to warm consente di ridurre l'intensità della luce e contemporaneamente riscaldare gli ambienti, creando atmosfere intime e rilassanti.

Light that evolves adapting to the mood and to specific needs. Opuntia's tunable white technology allows you to set warm or cold colors while the dim to warm technology allows you to reduce the intensity of light and at the same time warm up the environment, creating intimate and relaxing atmospheres.











wall

L 128 cm W 3,7 cm H 17 cm - L 50 $\frac{3}{8}$ " W 1 $\frac{1}{2}$ " H 6 $\frac{2}{3}$ "
LED 10W 750lm

wall

L 178 cm W 3,7 cm H 17 cm - L 70 $\frac{1}{8}$ " W 1 $\frac{1}{2}$ " H 6 $\frac{2}{3}$ "
LED 10W 750lm

table

Ø 8,2 cm W 52 cm H 51 cm - Ø 3 $\frac{1}{4}$ " W 20 $\frac{1}{2}$ " H 20"
LED 10W 750lm



RALPH

OFFICINA PANZERI

Studiata per consentire massima praticità e durevolezza nell'utilizzo in esterno, il paralume in rattan sintetico intrecciato a mano è di facile rimozione per il ritiro durante l'inverno. Il cavo di alimentazione in color arancione contrasta con il corpo monocromatico donando al prodotto un tocco di classe.

Designed for maximum practicality and durability in outdoor use, the hand-woven synthetic rattan lampshade is easy to remove during the winter. The power cable in orange contrasts with the monochromatic body giving the product a touch of class.







suspension
Ø 35 cm H 25 cm - Ø 13 ¾" H 9 7/8"
max 53W E27

suspension
Ø 50 cm H 34 cm - Ø 19 ¾" H 13 ¼"
max 53W E27

suspension
Ø 90 cm H 61 cm - Ø 35 ½" H 24"
max 53W E27

table
Ø 35 cm H 58 cm - Ø 13 ¾" H 22 7/8"
max 53W E27

floor
Ø 35 cm H 115 cm - Ø 13 ¾" H 45 ¼"
max 53W E27

floor
Ø 50 cm H 190 cm - Ø 19 ¾" H 74 7/8"
max 53W E27





SMOKE

SILVIA POMA

Smoke racconta l'antica lavorazione del vetro dei maestri veneziani. Tradizione e innovazione si fondono, ogni sfera è un prodotto unico realizzato a mano. Le sfumature del diffusore fanno amare questa lampada anche da spenta, la purezza della forma la rende adatta all'inserimento in ambienti di ogni stile.

Smoke tells the ancient glass workmanship of the Venetian masters. Tradition and innovation come together, each sphere is a unique handmade product. The nuances of the diffuser make this lamp irresistible when turned off, the purity of the shape makes it suitable for environments of any style.









suspension
Ø 26,7 cm - Ø 10 ½"
LED 21W 2500lm

suspension
Ø 35 cm - Ø 13 ¾"
LED 21W 2500lm

suspension
Ø 50 cm - Ø 19 ⅝"
LED 21W 2500lm



TUBINO

MATTEO THUN

Design semplice per una luce orientabile che soddisfa il bisogno di un oggetto dall'aspetto "puro" e "minimale" e per questo estremamente adattabile. Tubino nasce dalla ricerca dell'essenza della forma, della riscoperta dell'archetipo, di ciò che resiste alle mode ed è sempre attuale.

Simple design for an adjustable light that satisfies the need for an object with a "pure" and "minimal" design and therefore extremely adaptable. Tubino was born from the search for the essence of form, the rediscovery of the archetype, of what surpasses fashion and is always up-to-date.

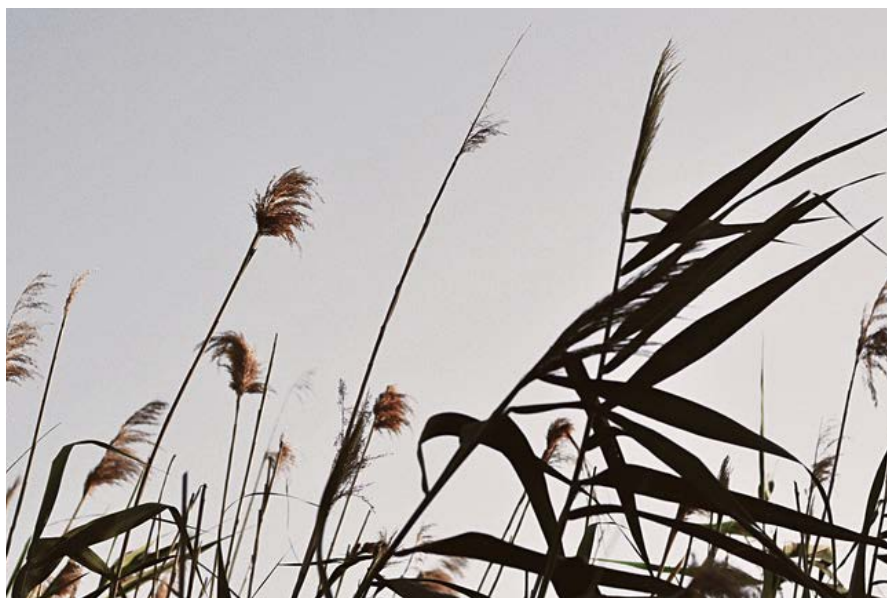







TUBINO

table

Ø 10,4 cm H 48 cm - Ø 4" H 19"
LED 6,5W 339lm

wall

Ø 4 cm H 23 cm - Ø 1 1/2" H 9"
LED 6,5W 339lm

suspension

Ø 4 cm H 23 cm - Ø 1 1/2" H 9"
LED 6,5W 339lm

floor

Ø 30 cm H 165 cm - Ø 11 5/8" H 65"
LED 13W 2x339lm







TUBINO PLUS
table
Ø 10,4 cm H 48 cm - Ø 4" H 19"
LED 6,5W 339lm



VENEXIA

MATTEO THUN

I pali di fondamenta in legno, le “briccole”, guidano le barche attraverso la città, dirigendosi verso Murano, sinonimo di vetro soffiato Made in Italy. La Laguna ispira la collezione Venexia, il design moderno è pensato per illuminare gli spazi esterni con una luce calda e piena di riflessi.

The wooden foundation piles, the “briccole”, guide the boats through the city, heading towards Murano, synonym for hand-blown glass Made in Italy. The Laguna inspires the Venexia collection, the modern design is conceived to illuminate outdoor spaces with a warm light full of reflections.









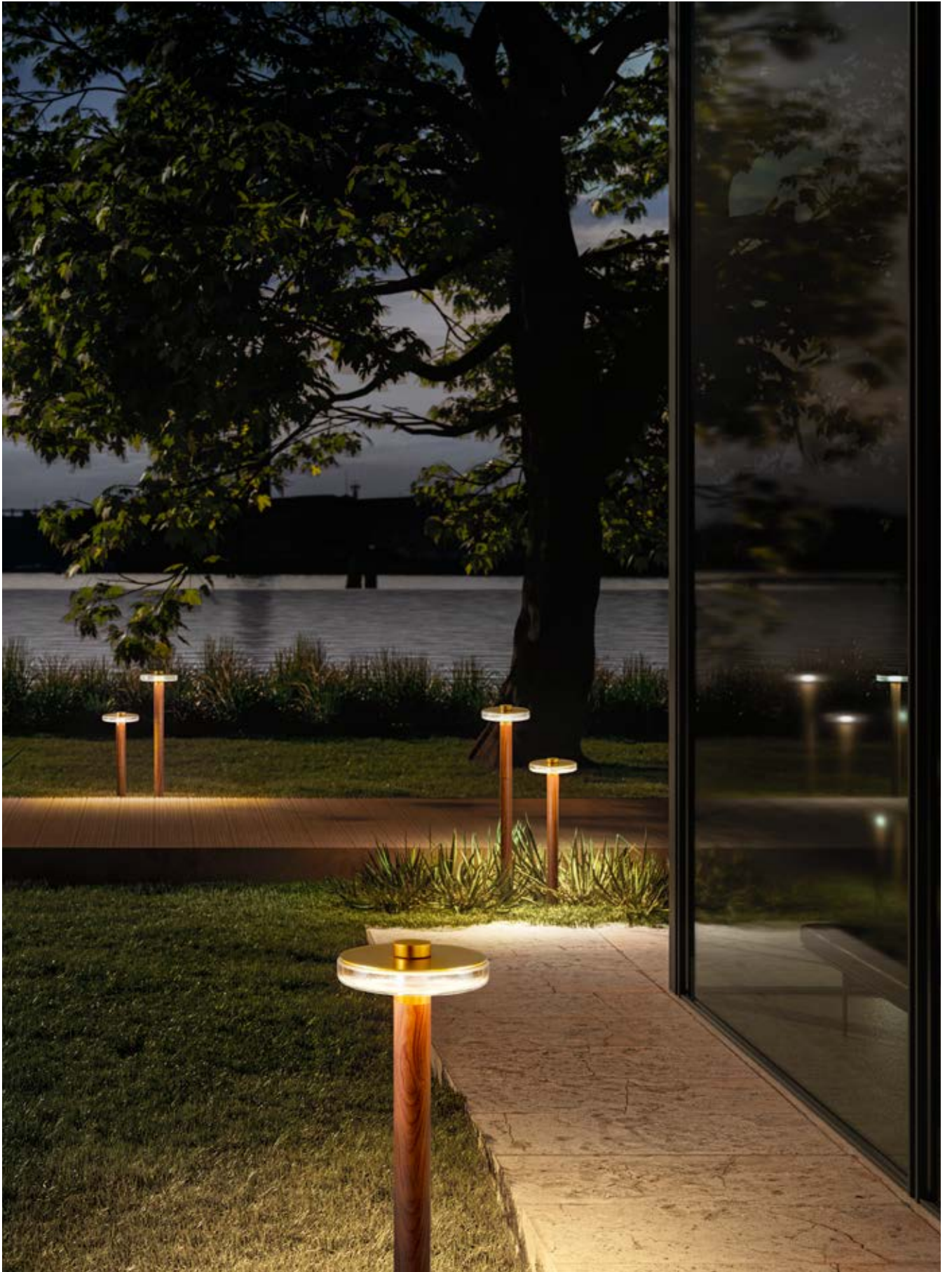



suspension

Ø 22 cm H 11 cm - Ø 8 ⅔" H 4 ⅓"
LED 8W 594lm

wall

Ø 22 cm H 14 cm - Ø 8 ⅔" H 5 ½"
LED 8W 594lm

floor

Ø 22 cm H 45 cm - Ø 8 ⅔" H 17 ¾"
Ø 22 cm H 70 cm - Ø 8 ⅔" H 27 ⅔"
Ø 22 cm H 95 cm - Ø 8 ⅔" H 37 ⅔"
LED 8W 594lm



VIISI

MINELLI | FOSSATI

Profilo slanciato e sezione pentagonale a spigoli netti, Viisi trae ispirazione dal giavellotto ed esprime leggerezza. Le estremità assottigliate seguono un principio aerodinamico, l'accostamento di elementi a emissione diretta e indiretta offre un elevato comfort visivo.

Slender profile and pentagonal section with sharp edges, Viisi draws inspiration from the javelin and conveys lightness. The thinned ends follow an aerodynamic principle, the combination of direct and indirect emission elements offers high visual comfort.









suspension

L 120 cm H 7,1 cm - L 47 3/4" H 2 4/5"
LED 23W 1188lm

suspension

L 210 cm H 7,1 cm - L 82 3/4" H 2 4/5"
LED 44W 2376lm

floor

Ø 34,7 cm H 213 cm - Ø 13 2/3" H 84"
LED 44W 2376lm





SU MISURA

BESPOKE

Ogni prodotto di design ha sempre avuto l'ambizione di essere unico, di trovare quello spazio che rende irripetibile ogni gesto della creazione, ogni momento della creatività, dunque essere "su misura" significa andare a creare le condizioni per risolvere un problema di unicità nell'essenza del percorso progettuale.

Every design product has always aspired to be inimitable, to sublimate the act of its own creation and every moment of creativity. Being "bespoke" means to resolve the issue of distinctiveness at the essence of the design planning journey.

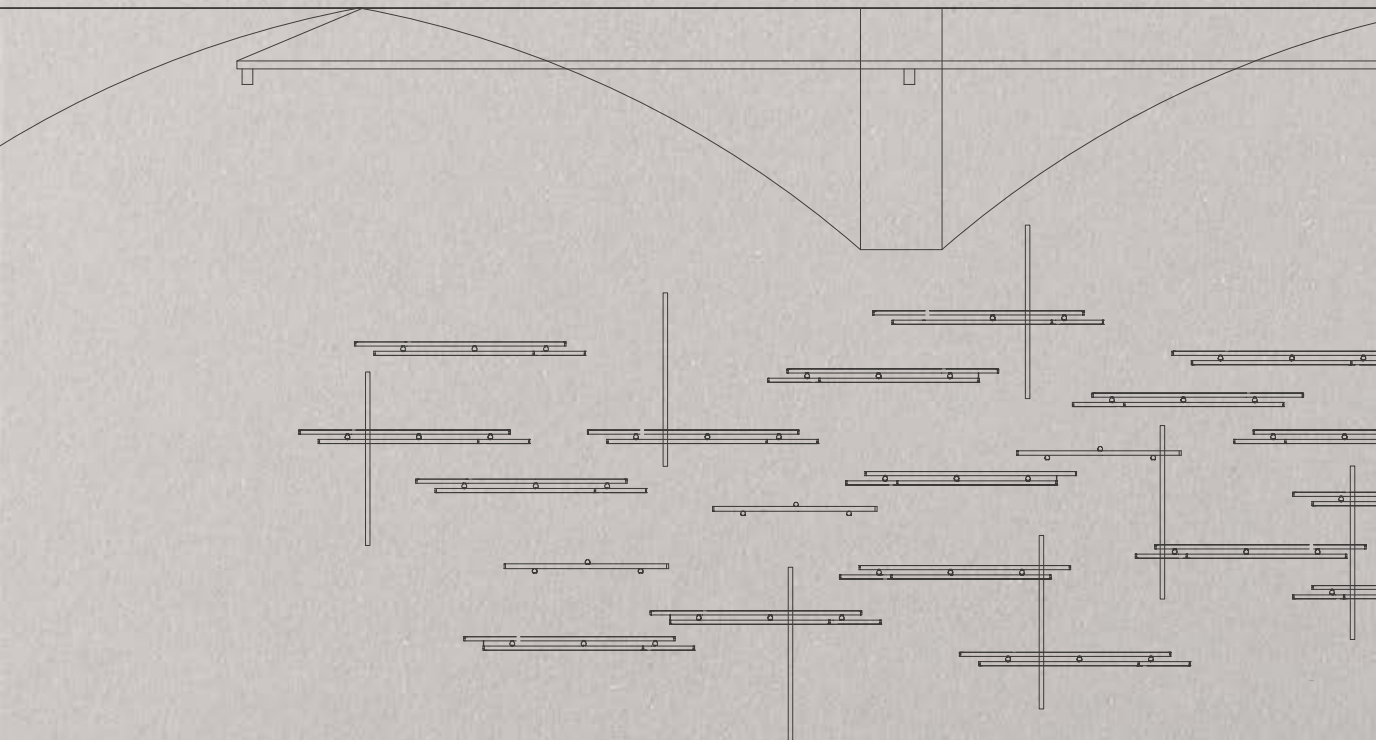

ARENA LISTONE GIORDANO

Milano, Italia

Lighting Installation: Matteo Thun & Partners

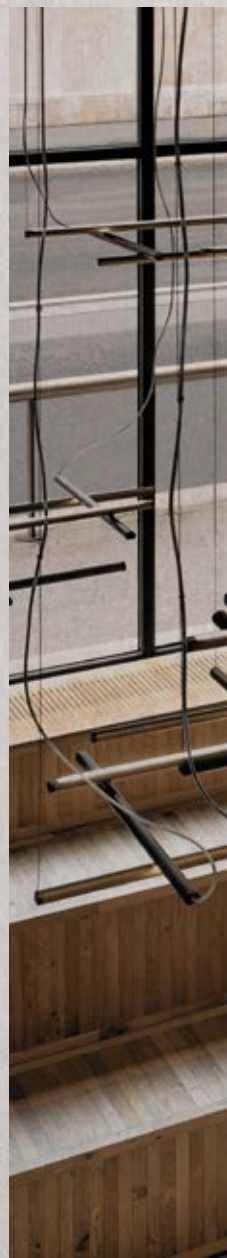
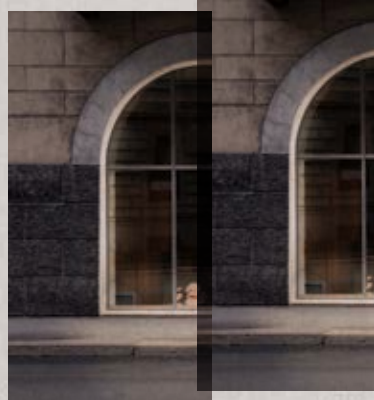
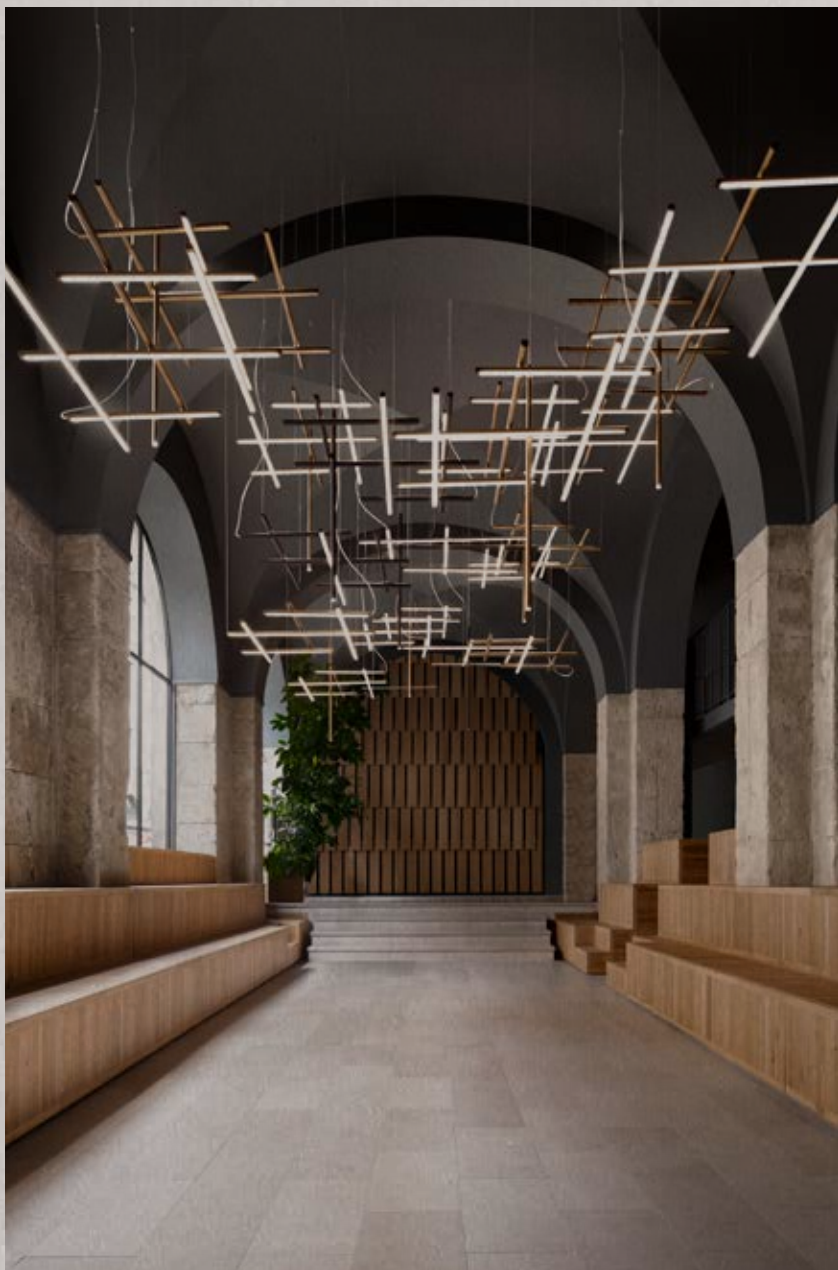

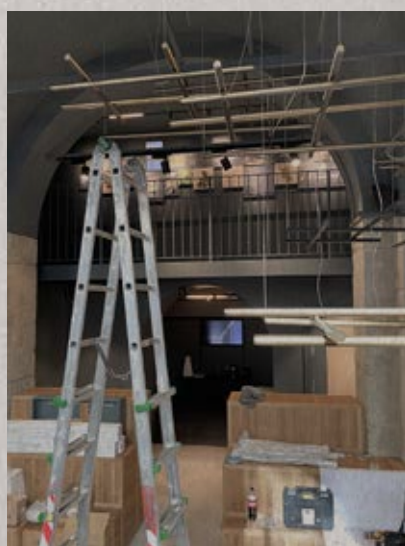
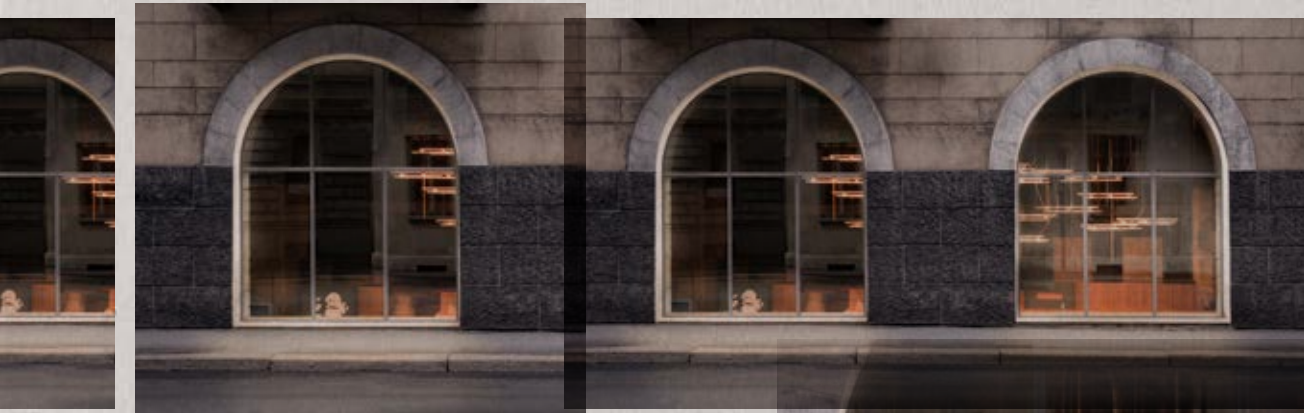



In questo meraviglioso universo delle idee, la luce, “la lampada” moltiplica esponenzialmente questa necessità perché l’immaterialità che proietta, che lancia nello spazio, rappresenta quella condizione essenziale che tende a differenziarsi da ogni altro esempio, come se la qualità del “su misura” fosse irrinunciabile.

In this marvellous universe made of ideas, the light and “the lamp” exponentially multiply this need of uniqueness. It emanates its immateriality and launches it into space. It represented that essential character to differentiate itself from any other case, as if “bespoke” was indispensable.



CASTELLANA 16 MADRID

Project: H2G2 Arquitectura e Ingenieria

Lighting Design: Iluminacion Delta Light Espana

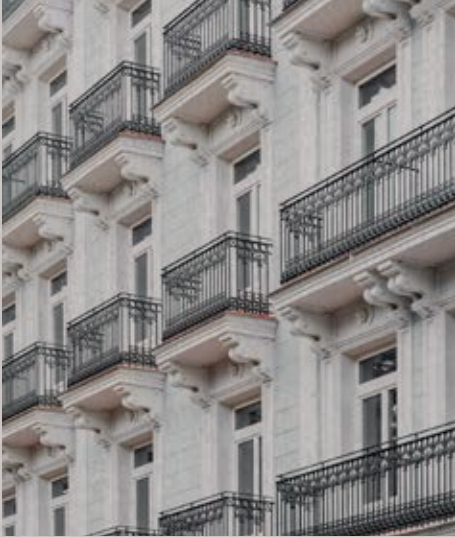

Quindi la tecnica e le tecnologie costruiscono per ogni prodotto, quello spazio culturale e progettuale che ogni produttore "illuminato" desidera, come se non esistessero alternative, e Panzeri esprime questa antica ma contemporanea volontà, come in un processo continuo di trasformazione e di miglioramento, negli anni, come se ogni lampada fosse "l'ultima lampada del mondo"

Thus, technique and technology shape for every product a cultural and aesthetical place that every "enlightened" producer wishes for, as if there were no alternatives. Panzeri conveys this ancient but contemporary will, like in a continuous process of transformation and improvement, throughout the years, as though every lamp would be "the last lamp in the world".



arch. Maurizio De Caro

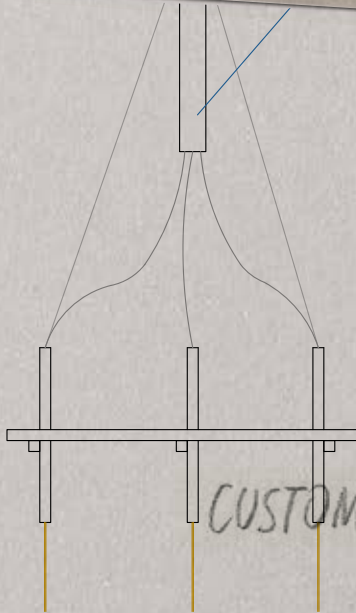
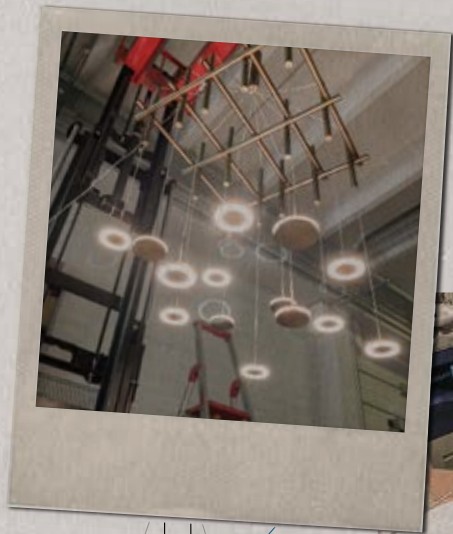

CUSTOM CANOPY FOR NR. 14 BELLA

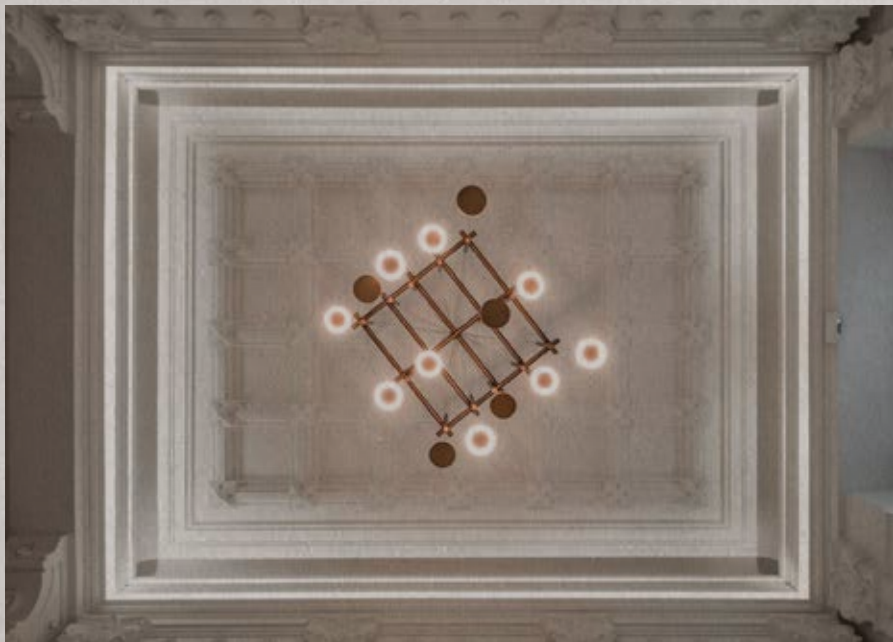

ZERO SHAPES

ENZO PANZERI

Quadrato, cerchio e ellisse.

Forme componibili e raggruppabili in disposizioni a sviluppo orizzontale o a cascata grazie a rosni studiati per alimentare più apparecchi. Le Zero Shapes valorizzano gli ambienti con linee discrete e eleganti, ricreando installazioni luminose di grande impatto scenografico.

Square, circle and ellipse. Combinable

shapes that can be grouped into horizontal or cascade arrangements thanks to canopies designed to power several lighting fixtures.

The Zero Shapes enhance environments with discreet and elegant lines by recreating light installations of great scenographic impact.











ZERO ROUND

suspension

Ø 50 cm H 3 cm - Ø 19 2/3" H 1 1/8"
LED 25W 2039lm

suspension

Ø 74 cm H 3 cm - Ø 29 1/8" H 1 1/8"
LED 36W 3059lm

suspension

Ø 98 cm H 3 cm - Ø 38 3/8" H 1 1/8"
LED 47W 4079lm







ZERO ROUND

wall

Ø 26 cm W 9,5 cm - Ø 10 ¼" W 3 ¾"
LED 13W 796lm

wall-ceiling

Ø 50 cm H 16 cm - Ø 19 ⅜" H 6 ½"
LED 29W 2039lm

wall-ceiling

Ø 74 cm H 19 cm - Ø 29 ⅙" H 7 ½"
LED 42W 3059lm

wall-ceiling

Ø 98 cm H 19 cm - Ø 38 ⅜" H 7 ½"
LED 54W 4079lm



ZERO ROUND VERTICAL

suspension

Ø 50 cm W 3 cm - Ø 19 ⅜" W 1 ½"
LED 25W 2039lm

suspension

Ø 74 cm W 3 cm - Ø 29 ⅙" W 1 ½"
LED 36 W 3059lm

suspension

Ø 98 cm W 3 cm - Ø 38 ⅜" W 1 ½"
LED 47W 4079lm





ZERO ELLIPSE
suspension
130x59 cm H 3 cm - 51 3/4" x 23 1/4" H 1 1/8"
LED 47W 4079lm





ZERO SQUARE

suspension

46 cm H 3 cm - 18 1/8" H 1 1/8"

LED 25W 2039lm

suspension

68 cm H 3 cm - 26 3/8" H 1 1/8"

LED 36W 3059lm







ZERO ROUND ACOUSTIC
suspension
Ø 98 cm H 3 cm - Ø 38 3/8" H 1 1/8"



ALDECIMO

CARMEN FERRARA

Un meccanismo a pressione studiato 'al decimo' consente di incassarla a parete o in arredo. In incasso un sistema di regolazione automatico riduce l'intensità della luce emessa ed illumina solo il profilo del quadrato. Può essere verniciata o rivestita e mimetizzarsi totalmente con il contesto.

A pressure mechanism designed with precision 'of tenth' allows it to be built into the wall or in furniture. When recessed, an automatic regulation system reduces the intensity of the light emitted and illuminates only the profile of the square. It can be painted or coated and completely blend in with the context.

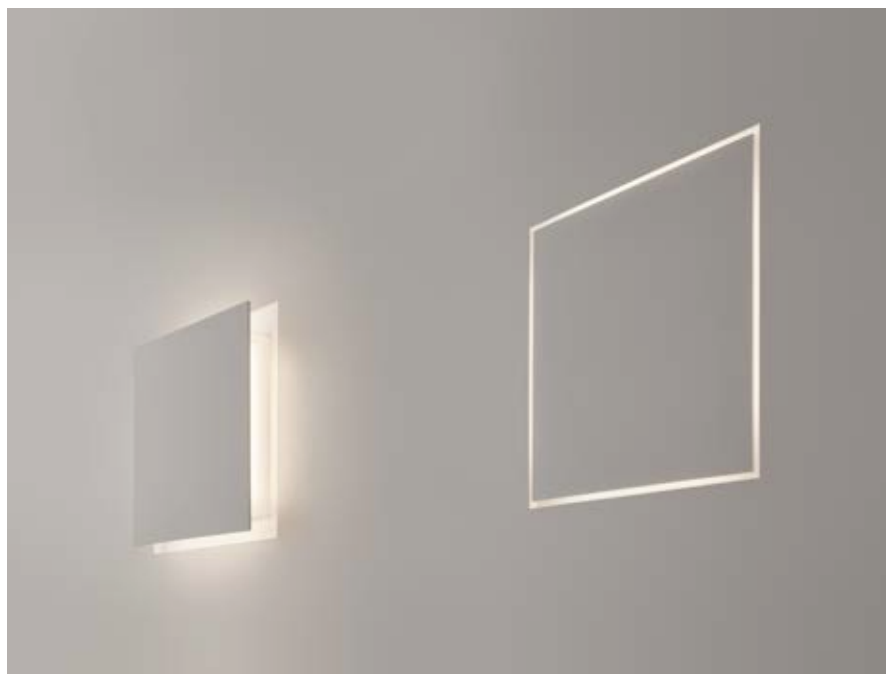



wall

24,9x24,9 cm W 4 cm - 11 3/8"x 11 3/8" W 1 1/2"
LED 21W 873lm



APP

Q²

App è una lampada a parete con emissione di luce volta verso l'alto. L'eleganza del corpo in alluminio deriva da un'attento studio dei dettagli, tra cui la scelta di grani a scomparsa per il fissaggio che donano al prodotto un aspetto ancora più minimale.

App is a wall lamp with upward light emission. The elegance of the aluminum body derives from a careful study of details, including the choice of hidden grub screws for fixing the backplate that give the product an even more minimal look.



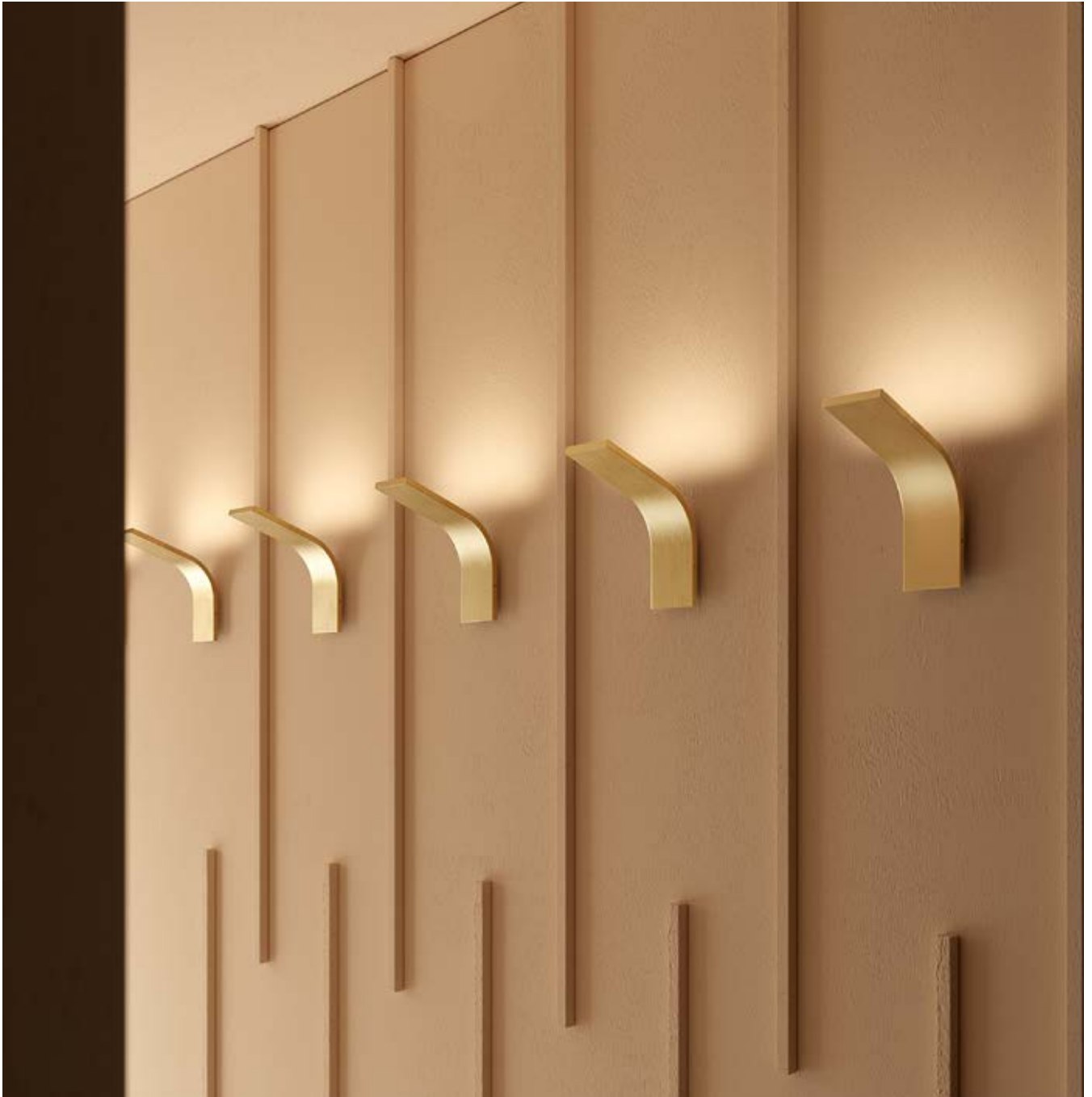

wall

L 12 cm H 20 cm - L 4 ¾" H 7 ¾"
LED 18W 1431lm

wall

L 24 cm H 20 cm - L 9 ½" H 7 ¾"
LED 36W 2862lm



BLANCA

FEDERICO CHURBA

La sorgente diventa un tutt'uno con la calotta cava dalla quale la luce si propaga internamente verso l'alto e verso il basso, producendo una piacevole sensazione di diffusione. Il design accattivante è impreziosito dal dettaglio del cavo di alimentazione in tessuto rosso.

The light source unites with the hollow spherical cap from which the light propagates internally upwards and downwards, producing a pleasant sensation of diffusion. The captivating design is embellished by the detail of the power cable in red fabric.

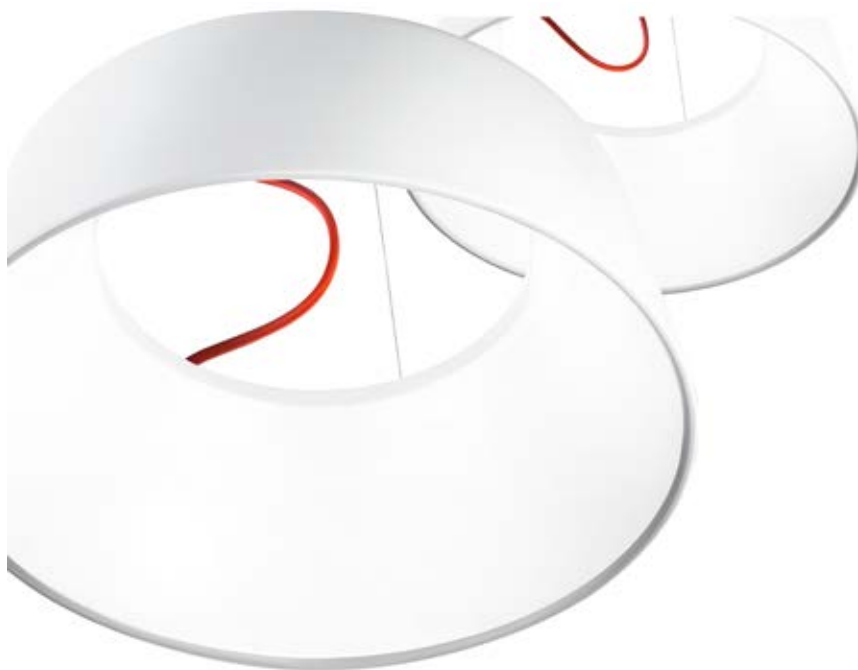



suspension

Ø 60 cm H 23 cm - Ø 23 5/8" H 9"
LED 70W 4654lm

suspension

Ø 89 cm H 28 cm - Ø 35" H 11"
LED 66W 4133lm



BRONX

ENZO PANZERI

Bronx è un profilo in alluminio ad incasso, caratterizzato dal posizionamento arretrato dello schermo e da un sistema semplificato per l'inserimento a scatto della sorgente luminosa, senza necessità di incollaggio. Pensiamo al prodotto in modo sostenibile, consentendo una pratica manutenzione durante l'intero ciclo di vita.

Bronx is a recessed aluminum profile, characterized by the recessed positioning of the diffuser and by a simplified system for the snap-in insertion of the light source, without the need for gluing. We think about the product in a sustainable way, allowing a practical maintenance during the entire life cycle.

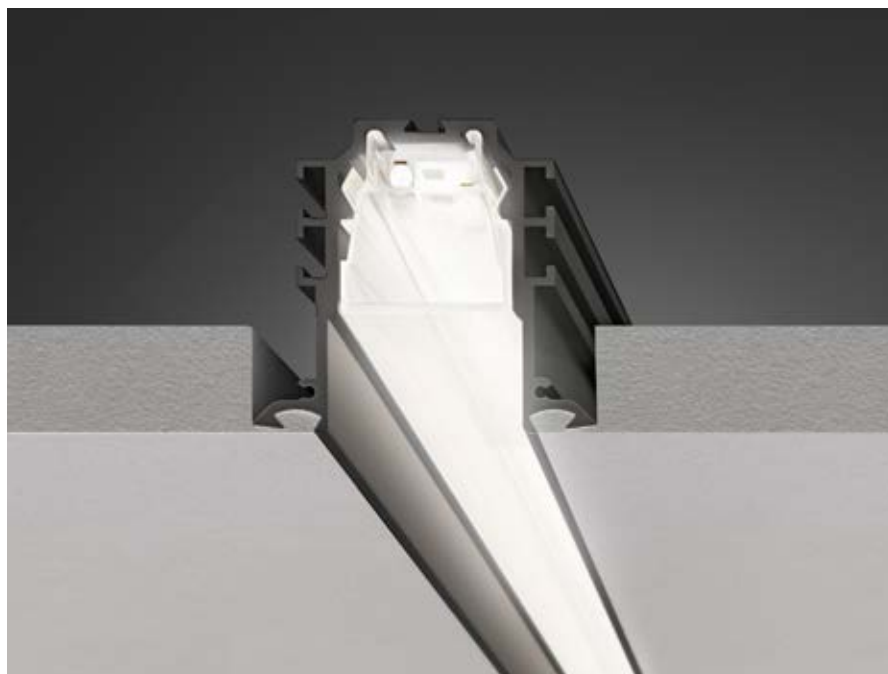



profiles

L 510 mm - L 20"

L 1010 mm - L 39 7/8"

L 2010 mm - L 79 1/2"

L 3010 mm - L 118 3/8"

LED MODULE

500 mm - 19 3/8" 8,6W 1140lm

125 mm - 5" 2,15W 285lm





TRADIZIONE NELL'INNOVAZIONE

TRADITION APPLIED TO INNOVATION

Il passato è la matrice di ogni gesto creativo contemporaneo, ne configura la capacità di produrre momenti innovativi, come in una linea continua che unisce quello che ha costruito il nostro paesaggio degli oggetti, prima di diventare testimonianza del futuro del progetto di design.

The past is the origin of each contemporary creative gesture, it configures its ability to produce innovative moments, as in a continuous line connecting the objects of our landscape, before becoming the testament of the future design project.



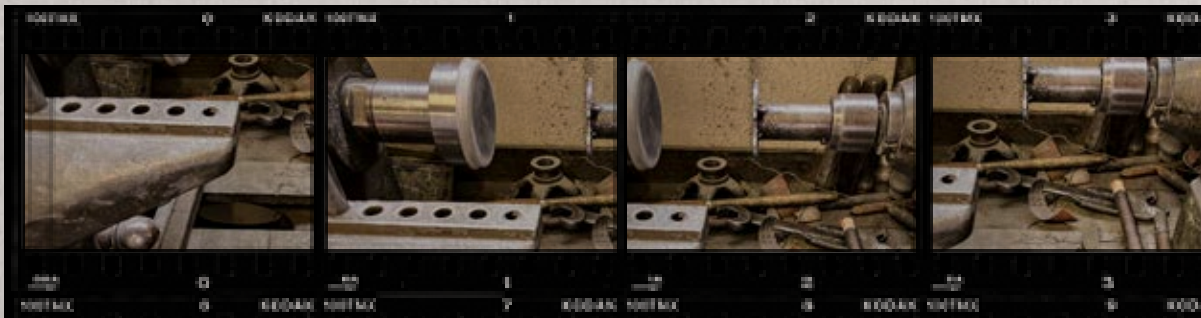
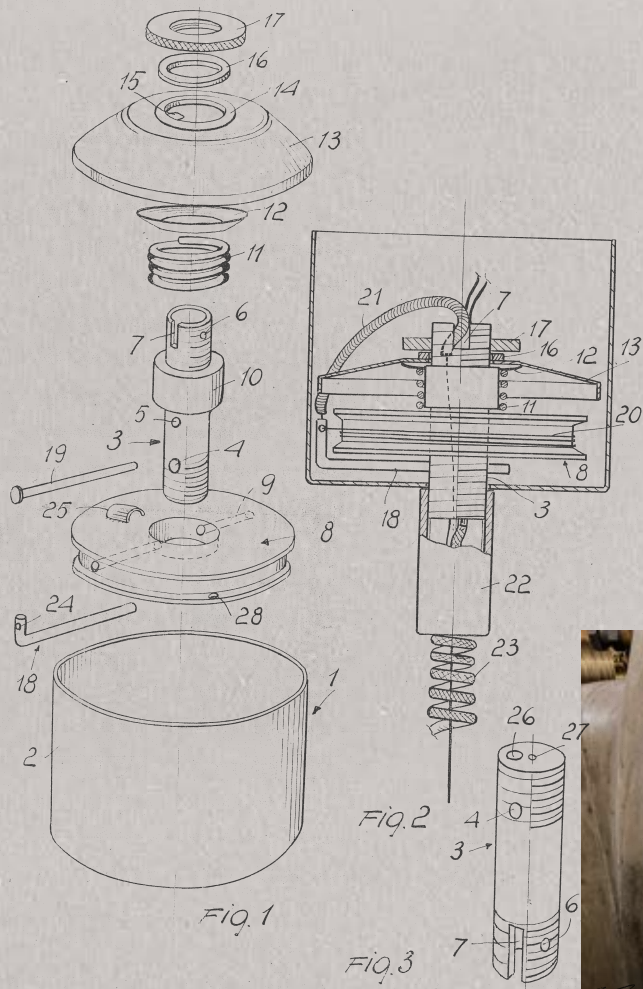

Dunque è un flusso incostante che miscela esperienze diverse e momenti storici che hanno plasmato il percorso millenario della creatività. Panzeri ha un'esperienza significativa all'interno di questa dialettica tra "antico" e "immaginario", come in una sequenza di episodi, di capitoli di un racconto sempre in trasformazione, perennemente in divenire.

Therefore, it is an unstable flow that blends different experiences and historical times that molded the millennial path of creativity. Panzeri owns a substantial experience in this dialectic between "antique" and "imaginative", as in a sequence of episodes, or chapters, of a story-telling constantly in transformation, perpetually in progress.



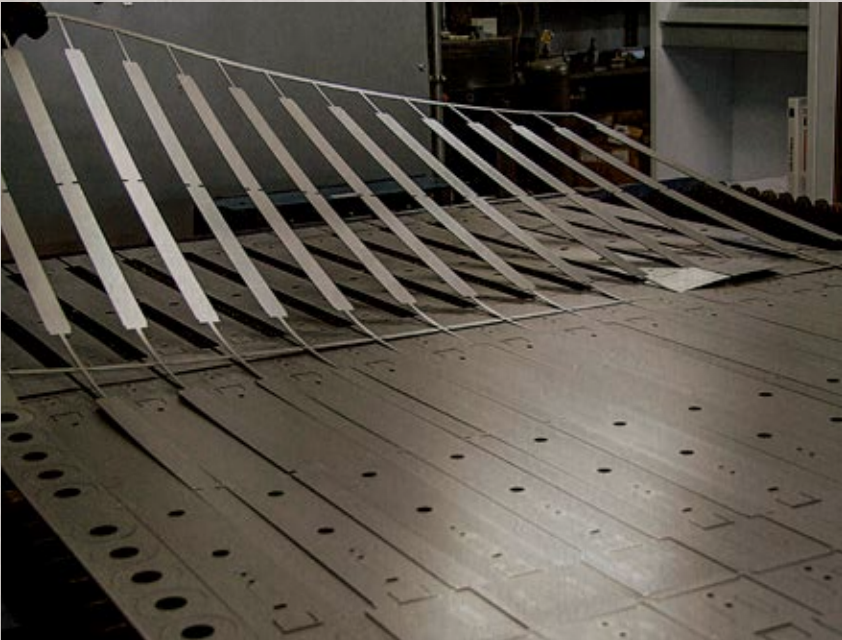



La storia della bellezza è costellata di tanti momenti di svolta e quella della cultura del progetto è un'infinita sequenza di svolte che hanno incatenato indissolubilmente l'innovazione alla tradizione, anche quando avevano la necessità di negare questo legame.

The history of beauty is sprinkled with many turning points and that of the project culture is an endless sequence of changes of direction that inextricably connects innovation to tradition, even when they had the necessity to deny such connection.

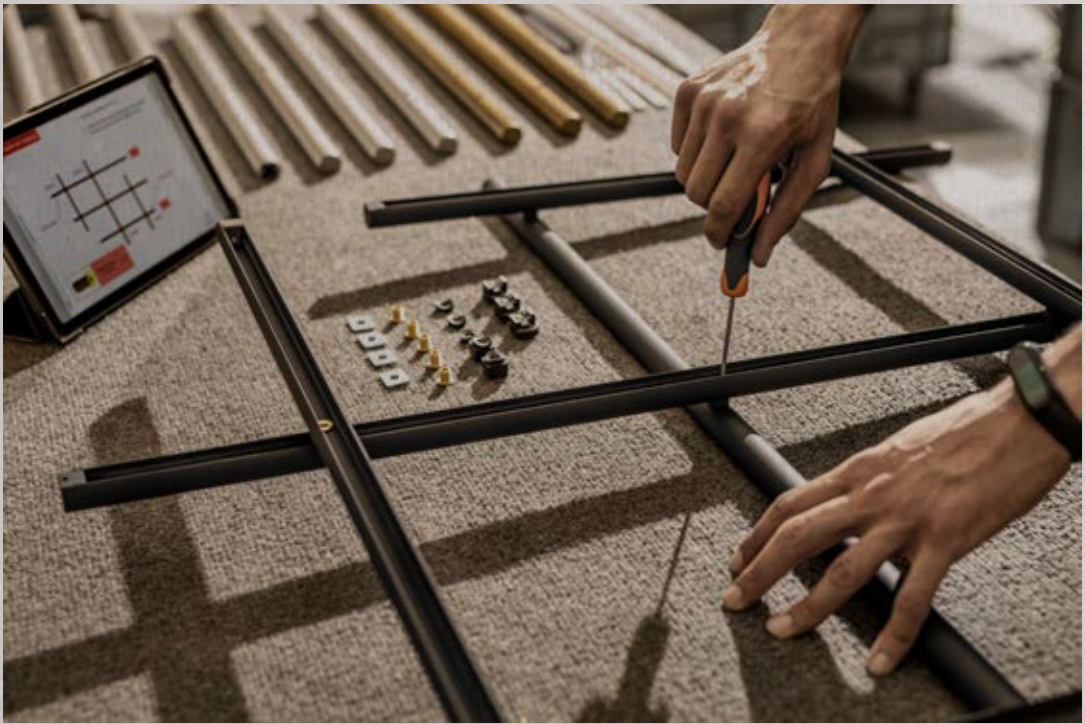



Non è un tornare al passato, ma interpretarne le caratteristiche che ci hanno portato a fare le scelte di oggi, a costruire i meccanismi che rendono le nostre lampade, i nostri progetti frutto di un'attenta lettura di quello che siamo stati come uomini, come progettisti e come imprenditori.



It is not a return to the past, it is a reinterpretation of the characteristics that brought us to make today's choices, to create those mechanisms that make our lamps, and our projects, the result of a careful study of what we have been as humans, as designers, as entrepreneurs.

arch. Maurizio De Caro

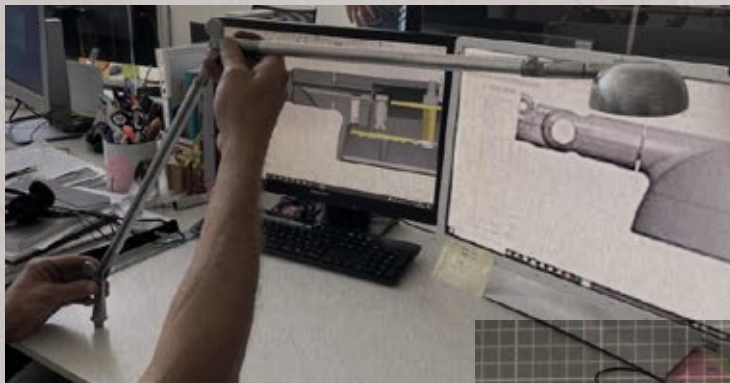

BROOKLYN

ENZO PANZERI

Brooklyn è una lampada a soffitto e a sospensione, a sviluppo lineare o curvilineo - disponibile a cerchio e semicerchio. Brooklyn è anche un sistema per percorsi di luce continua che si estendono a soffitto e a parete lasciando spazio all'immaginazione nella definizione del pattern più adatto al progetto.

Brooklyn is a ceiling and suspension lamp, with linear or curvilinear shape - available in circle and semicircle. Brooklyn is also a system for continuous light paths that extend to ceiling and walls, giving room to creativity in defining the most suitable pattern for the project.





BROOKLYN ROUND

profiles

360° Ø 1000 mm - Ø 39 3/8"
 180° Ø 1000 mm - Ø 39 3/8"
 90° Ø 1000 mm - Ø 39 3/8"
 360° Ø 1950 mm - Ø 76 5/8"
 180° Ø 1950 mm - Ø 76 5/8"
 90° Ø 1950 mm - Ø 76 5/8"
 45° Ø 1950 mm - Ø 76 5/8"

LED MODULE

45° 6,6W 855lm
 22,5° 6,6W 855lm



BROOKLYN

profiles

L 510 mm - L 20"
 L 1010 mm - L 39 3/8"
 L 2010 mm - L 79 1/8"
 L 3010 mm - L 118 3/8"

LED MODULE

500 mm - 19 3/8" 8,6W 1140lm
 125 mm - 5" 2,15W 258lm
 5000 mm - 197" 21,6W/m 3020lm/m
 5000 mm - 197" 17W/m 1964lm/m
 5000 mm - 197" 10W/m 1200lm/m







BROOKLYN ROUND

suspension / ceiling / wall with circular shape

Ø 100 cm H 3,5 cm - Ø 39 7/8" H 1 3/8"

LED 55W 2965lm

Ø 195 cm H 3,5 cm - Ø 76 5/8" H 1 3/8"

LED 109W 5931lm

suspension / ceiling / wall with semicircular shape

Ø 100 cm H 3,5 cm - Ø 39 7/8" H 1 3/8"

LED 29W 1483lm

Ø 195 cm H 3,5 cm - Ø 76 5/8" H 1 3/8"

LED 55W 2965lm





BROOKLYN LINE
suspension

L 102 cm H 3,5 cm - L 40 1/5" H 1 3/8"
LED 20W 1142lm

L 152 cm H 3,5 cm - L 59 5/8" H 1 3/8"
LED 29W 1713lm



BROOKLYN SPOT
ceiling

L 35 cm H 7,5 cm - L 13 4/5" H 3"
LED 10W 698lm



CANDLE

SILVIA POMA

La magia della luce vibrante e raccolta di una candela. L'accoppiamento di vetro borosilicato trasparente e satinato reinterpreta la classicità delle sospensioni di un tempo in chiave attuale, installazioni custom di grandi dimensioni creano emozionanti atmosfere da fiaba.

The magic of the vibrant and intimate light of a candle. The combination of transparent and frosted borosilicate glass reinterprets the classicism of the suspensions of the past in a modern key, large custom installations create impressive fairytale atmospheres.





suspension

Ø 3 cm H 55 cm - Ø 1 1/2" H 22"

LED 4W 238lm



CORNER

ENZO PANZERI

Un sistema che si nasconde negli spigoli tra soffitto e parete, producendo un effetto di luce a scomparsa. Il posizionamento in radenza della sorgente luminosa mette in risalto le finiture e in installazioni perimetrali continue determina la percezione di un 'soffitto sospeso'.

A system that hides in the corners between the ceiling and the wall, producing a disappearing light effect. The grazing positioning of the light source highlights the finishes and in continuous perimeter installations determines the perception of a 'suspended ceiling'.

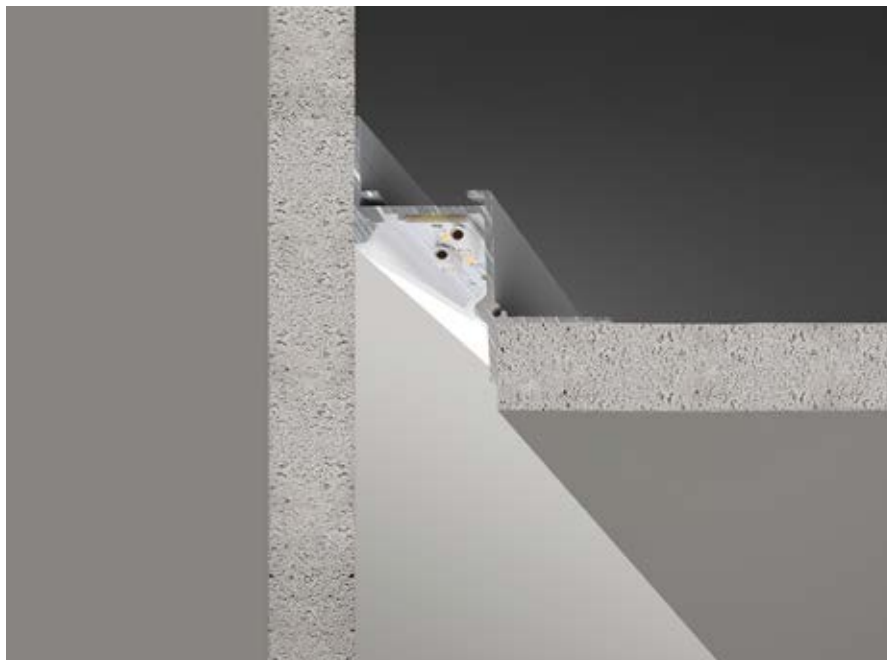



profiles

L 510 mm - L 20"

L 1010 mm - L 39 7/8"

L 2010 mm - L 79 1/8"

L 3010 mm - L 118 3/8"

LED MODULE

500 mm - 19 2/3" 8,6W 1140lm

125 mm - 5" 2,15W 258lm

5000 mm - 197" 21,6W/m 3020lm/m

5000 mm - 197" 17W/m 1964lm/m

5000 mm - 197" 10W/m 1200lm/m



GIANO

OFFICINA PANZERI

Giano è una lampada a parete e a sospensione a doppia emissione. Giano è anche un sistema per costruire linee di luce di notevole estensione nell'illuminazione di grandi spazi. L'integrazione del driver all'interno del profilo risolve problematiche di remotizzazione e offre massima flessibilità nell'installazione.

Giano is a double emission wall and suspension lamp. Giano is also a system for constructing lines of light of considerable extension in the illumination of large spaces. The integration of the driver within the profile solves remote control problems and offers maximum flexibility in installation.







GIANO

suspension

L 151,5 cm H 9,8 cm - L 59 2/3" H 3 5/8"
LED 56W 4541lm

suspension

L 201,5 cm H 9,8 cm - L 79 2/5" H 3 5/8"
LED 72W 6055lm

wall

L 26,9 cm H 9,8 cm - L 10 3/5" H 3 5/8"
LED 11W 614lm

wall

L 51,8 cm H 9,8 cm - L 20 2/3" H 3 5/8"
LED 19W 1228lm

wall

L 101,8 cm H 9,8 cm - L 40" H 3 5/8"
LED 38W 2456lm

wall

L 151,5 cm H 9,8 cm - L 59 2/3" H 3 5/8"
LED 56W 3683lm



profiles

L 515 cm - L 20 2/3"
L 1015 cm - L 40"
L 2015 cm - L 79 2/5"
L 3015 cm - L 118 4/5"

LED MODULE

500 mm - 19 2/3" 8,6W 1140lm
125 mm - 5" 2,15W 258lm
5000 mm - 197" 21,6W/m 3020lm/m
5000 mm - 197" 17W/m 1964lm/m
5000 mm - 197" 10W/m 1200lm/m



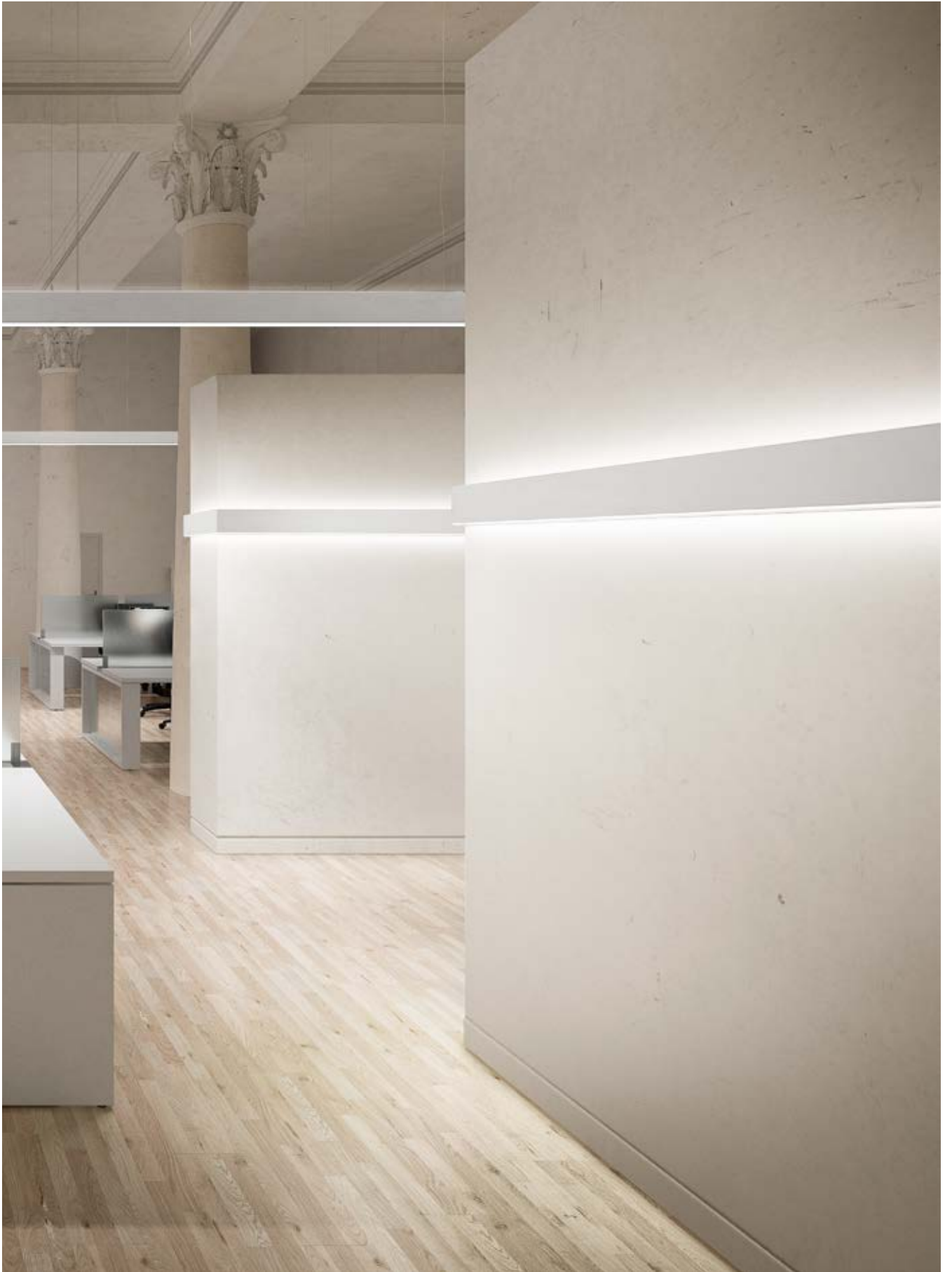

GILBERT

OFFICINA PANZERI

La precisione industriale incontra l'unicità del fatto a mano del vetro soffiato opale, in un prodotto che diffonde una luce morbida e uniforme. La declinazione a sospensione è arricchita dal dettaglio del doppio cavo di alimentazione in colore rosso.

Industrial precision meets the uniqueness of the hand-made opal blown glass, in a product that diffuses a soft and uniform light. The suspension version is enriched by the detail of the double power cable in red color.





suspension

Ø 22 cm H 14 cm - Ø 8 ⅔" H 5 ½"
LED 11W 929lm

suspension

Ø 37 cm H 27 cm - Ø 14 ⅞" H 10 ⅔"
LED 27W 2525lm

suspension

Ø 45 cm H 33 cm - Ø 17 ¾" H 13"
LED 27W 2525lm

ceiling

Ø 37 cm H 27 cm - Ø 14 ⅞" H 10 ⅔"
LED 20W 1840lm

ceiling

Ø 45 cm H 33 cm - Ø 17 ¾" H 13"
LED 20W 1840lm

table

Ø 22 cm H 14 cm - Ø 8 ⅔" H 5 ½"
LED 11W 692lm



GONG

OFFICINA PANZERI

Gong caratterizza con classe gli ambienti in cui si inserisce per la bellezza insita nella purezza della sua forma. Il disco del corpo lampada accenna alla tridimensionalità grazie all'attento lavoro di tornitura a cui viene sottoposto.

Gong characterizes with class the environments in which it is placed for the beauty inherent in the purity of its shape. The disc of the lamp body hints at three-dimensionality thanks to the careful turning work made on it.



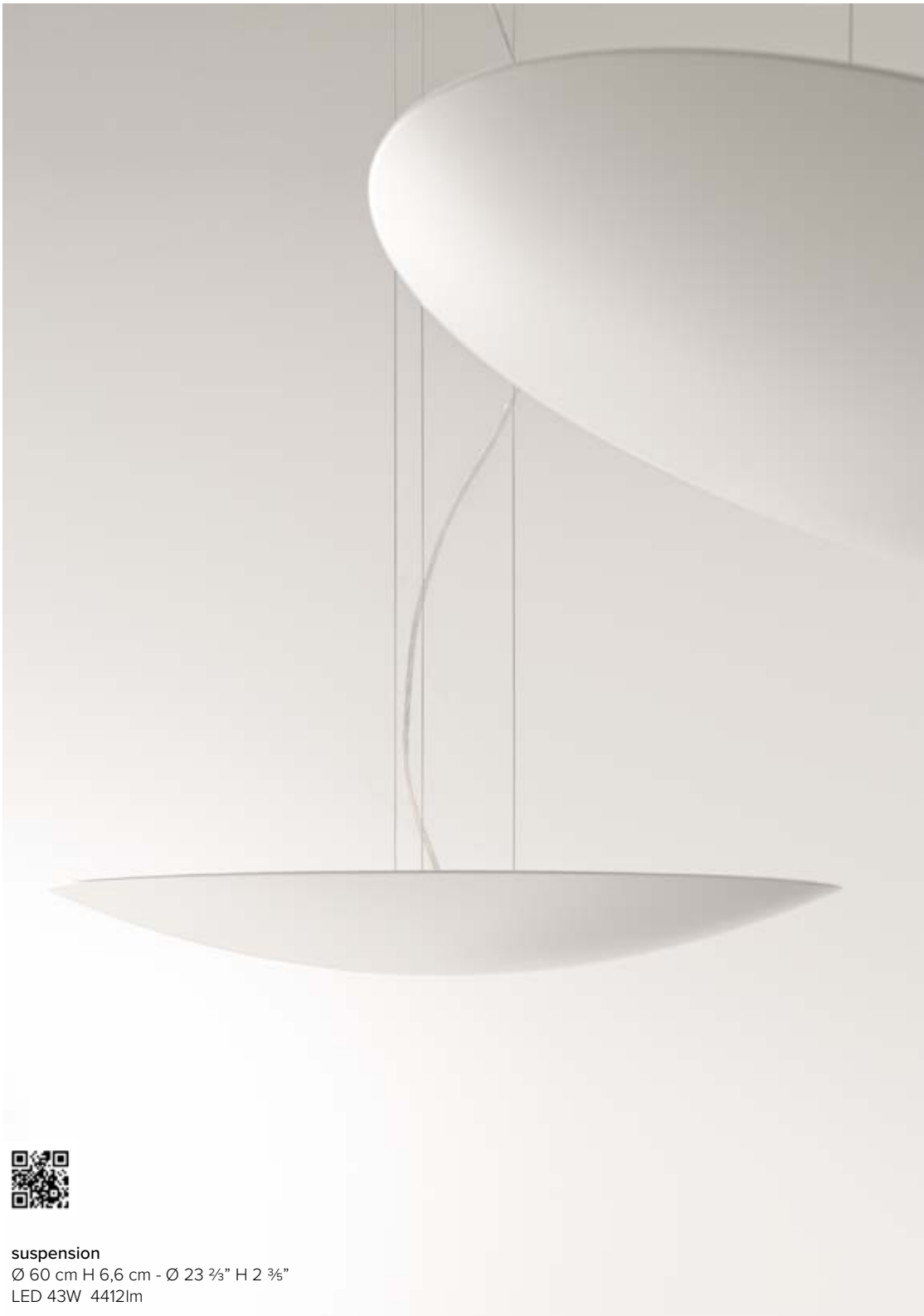

suspension

Ø 60 cm H 6,6 cm - Ø 23 2/3" H 2 3/8"
LED 43W 4412lm

suspension

Ø 96 cm H 7,5 cm - Ø 37 5/8" H 3"
LED 88W 8825lm





CONCEIVED (AND MADE) IN ITALY

Forse il pensiero si caratterizza per una dislocazione geografica e fisica perché gli oggetti pensati in un luogo specifico hanno una caratterizzazione che li rende riconoscibili e non si può negare questo processo di identificazione che parte dal conceived in Italy, per arrivare al made in Italy.

Perhaps the mindset is defined by geographical or physical location because objects conceived in a specific place have a characterization that makes them recognizable, and it's impossible to deny the identification process that originates from the conceived in Italy to arrive to the made in Italy.

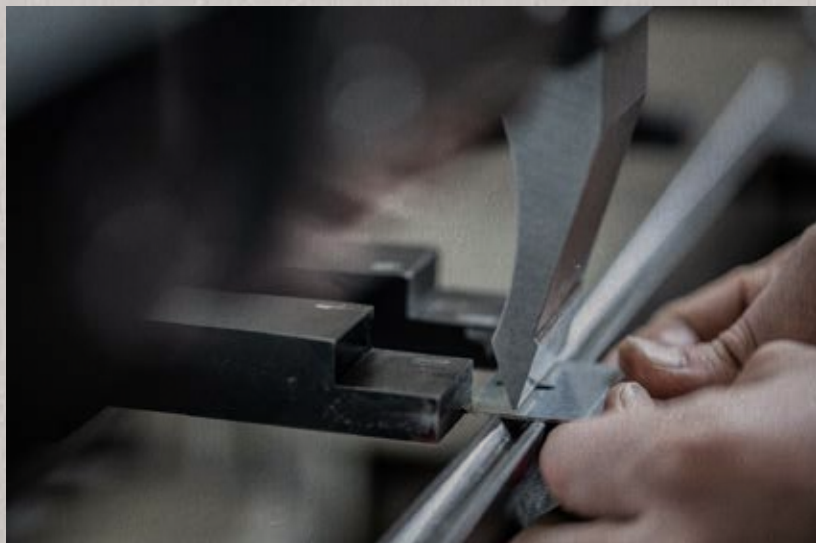



made in Italy



Talmente significativo da aver raggiunto la dimensione di uno stile, di un principio ordinatore, di una sequenza di gesti che conducono l'idea ad una particolare realizzazione, in un percorso consolidato nel tempo e nella storia che costruiscono da sempre la nostra "Identità Italiana".

So significant to achieve the dimension of a style, of an organizing principle, of a sequence of gestures that take the idea to the realization, in a path consolidated over time and history that carve out our "Italian identity".



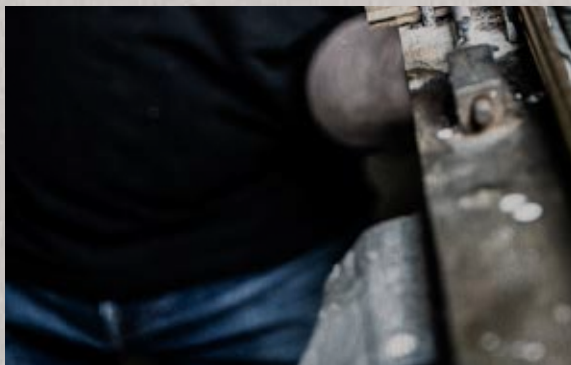
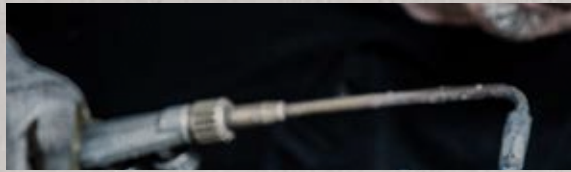



Probabilmente tutto questo nasce dalla stratificazione delle nostre antiche conoscenze manuali, artigianali, artistiche e industriali che rendono particolare ogni prodotto, ma nel design della luce questo percorso è ancora più evidente perché la "Lampada Panzeri" ha una densità di gesti e di segni che la rendono direttamente connessa col pensiero "alto" che l'ha generata.

Probably all of this originates in the stratification of our ancient manual, artisanal, artistic, industrial skills that make every product distinctive. However, in the design of lighting, this journey is even more undeniable because the "Panzeri lamp" contains a density of gestures and signs that connects it directly to the "elevated" thought that generated it.



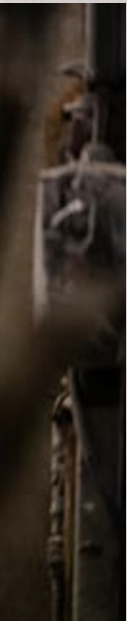

Un pensiero inimitabile, logico,
denso di conoscenze etiche,
estetiche e produttive, una sintesi
concettuale che non ammette
imitazioni, trasparente come solo la
luce è in grado di essere.

An inimitable thought, logical and
full of ethical, aesthetical, and
productive skills, a conceptual
summary that does not accept
imitations, transparent like only
light can be.

arch. Maurizio De Caro





RING COLLECTION

ENZO PANZERI

La collezione Rings è composta da anelli che si differenziano sia per dimensione che per tipologia di diffusione della luce, mono o biemissione. La varietà di soluzioni combinabili ne consente l'applicazione in ambienti di ogni genere, dal residenziale ai grandi spazi pubblici.

The Rings collection consists of rings that differ both in size and in the type of light diffusion, single or double emission. The variety of combinable solutions allows their positioning in all kinds of environments, from residential to large public spaces.





SILVER RING

suspension

Ø 54 cm H 8 cm - Ø 21 3/4" H 3 1/2"
LED 25W 1809lm

suspension

Ø 78 cm H 8 cm - Ø 30 3/4" H 3 1/2"
LED 45W 3053lm

suspension

Ø 123 cm H 8 cm - Ø 48 1/2" H 3 1/2"
LED 75W 5233lm

suspension

Ø 183 cm H 8 cm - Ø 72 1/8" H 3 1/2"
LED 110W 7850lm

ceiling/wall

Ø 54 cm H 8 cm - Ø 21 3/4" H 3 1/2"
LED 25W 1809lm

ceiling/wall

Ø 78 cm H 8 cm - Ø 30 3/4" H 3 1/2"
LED 45W 3053lm

ceiling/wall

Ø 123 cm H 8 cm - Ø 48 1/2" H 3 1/2"
LED 75W 5233lm

ceiling/wall

Ø 183 cm H 8 cm - Ø 72 1/8" H 3 1/2"
LED 110W 7850lm







GOLDEN RING

suspension

Ø 78 cm H 15 cm - Ø 30 ¾" H 6"
LED 87W 3053+3053lm

suspension

Ø 123 cm H 15 cm - Ø 48 ½" H 6"
LED 150W 5233lm+5233lm

suspension

Ø 183 cm H 15 cm - Ø 72 ⅞" H 6"
LED 220W 7850lm+7850lm

suspension

Ø 301 cm H 15 cm - Ø 118 ⅜" H 6"
LED 370W 13083lm+13083lm







PLANET RING

ceiling

Ø 41 cm H 9 cm - Ø 16 1/8" H 3 5/8"
LED 28W 2199lm

ceiling

Ø 65 cm H 9 cm - Ø 25 3/8" H 3 5/8"
LED 71W 5864lm

ceiling

Ø 95 cm H 9 cm - Ø 37 3/8" H 3 5/8"
LED 142W 11727lm

suspension

Ø 65 cm H 9 cm - Ø 25 3/8" H 3 5/8"
LED 71W 5864lm

suspension

Ø 95 cm H 9 cm - Ø 37 3/8" H 3 5/8"
LED 142W 11727lm





recessed

Ø 43 cm H 9 cm - Ø 17" H 3 5/8"
LED 28W 2199lm

recessed

Ø 67 cm H 9 cm - Ø 26 2/5" H 3 5/8"
LED 71W 5864lm



TO-BE

ENZO PANZERI

To-be è essenziale, illumina con discrezione e offre un elevato comfort visivo grazie al posizionamento arretrato dello schermo. Si presta a giochi compositivi in cui affiancare elementi di diverso diametro e altezza, adatta anche come luce da comodino.

To-be is essential, it illuminates with discretion and offers high visual comfort thanks to the recessed positioning of the screen. It is suitable for compositional games in which elements of different heights and diameters are placed side by side, also suitable as a bedside light.





suspension

Ø 2,2 cm H 85 cm - Ø 0,8" H 33 ½"
LED 4W 181lm

suspension

Ø 3,2 cm H 65 cm - Ø 1 ½" H 25 ¾"
LED 7W 363lm

suspension

Ø 5,5 cm H 45 cm - Ø 2 ½" H 17 ¾"
LED 10W 806lm

ceiling

Ø 5,5 cm H 45 cm - Ø 2 ½" H 17 ¾"
LED 10W 806lm



TOY TOY GYPSO

OFFICINA PANZERI

Toy è una lampada a parete con emissione di luce diretta e indiretta, disponibile in diverse lunghezze per installazioni singole e composizioni di più elementi. Fornita anche nella versione in gesso, che può essere tinteggiata e rivestita come la parete, mimetizzandosi perfettamente con essa.

Toy is a wall lamp with direct and indirect light emission, available in different lengths for single installations and compositions of several elements. Also supplied in the Gypso version, which can be painted and covered like the wall, blending in perfectly with it.



TOY GYPSO

wall

L 27 cm H 8,5 cm W 9,5 cm - L 10 ½" H 3 ¼" W 3 ¾"
LED 13W 878lm

wall

L 61 cm H 8,5 cm W 9,5 cm - L 24" H 3 ¼" W 3 ¾"
LED 35W 2633lm





TOY

wall

L 7,5 cm H 7,5 cm W 8,5 cm - L 3" H 3" W 3 1/4"
max 48W G9

wall

L 25 cm H 7 cm W 8,5 cm - L 9 7/8" H 2 3/4" W 3 1/4"
LED 13W 878lm

wall

L 45,5 cm H 7 cm W 8,5 cm - L 18" H 2 3/4" W 3 1/4"
LED 24W 1755lm

wall

L 61 cm H 7 cm W 8,5 cm - L 24" H 2 3/4" W 3 1/4"
LED 35W 2633lm

wall

L 88,5 cm H 7 cm W 8,5 cm - L 34 7/8" H 2 3/4" W 3 1/4"
LED 45W 3510lm



WILLY ALU WILLY GLASS WILLY XL

ENZO PANZERI

Diffusore a campana reminiscenza di un linguaggio industriale ripensato in chiave contemporanea. Willy è una famiglia di sospensioni disponibili in vetro soffiato, alluminio e polietilene, un ventaglio di soluzioni che soddisfa ogni esigenza di stile.

Bell-shaped diffuser reminiscent of an industrial language re-thought in a contemporary key. Willy is a family of suspensions which is available in blown glass, aluminum and polyethylene, a range of solutions that satisfy every style requirement.



WILLY ALU
suspension

Ø 60 cm H 37 cm - Ø 23 5/8" H 14 5/8"
3x max 100W E27







WILLY GLASS

suspension

Ø 40 cm H 28 cm - Ø 15 ¾" H 11"
max 150W E27

suspension

Ø 50 cm H 30 cm - Ø 19 ⅝" H 11 ¾"
max 150W E27

suspension

Ø 60 cm H 37 cm - Ø 23 ⅝" H 14 ⅝"
LED 40W 3587lm



WILLY XL

suspension

Ø 100 cm H 63 cm - Ø 39 ⅜" H 24 ⅝"
LED 40W 3587lm





ZERO

OFFICINA PANZERI

Zero è una lampada a parete in ottone. Il corpo lampada è sottile, a sezione cava. La parte emittente è distanziata dalla parete ed illumina gli ambienti con luce riflessa. Un prodotto di elevata qualità sia per caratteristiche materiche che per comfort visivo ottenuto.

Zero is a brass wall lamp. The lamp body is thin, with a hollow section. The emitting part is spaced from the wall and illuminates the rooms with reflected light. A high quality product both for material characteristics and for the visual comfort obtained.





wall
L 52 cm H 3 cm W 7,5 cm - L 20 ½" H 1 ½" W 3"
LED 11W 613lm

wall
L 102 cm H 3 cm W 7,5 cm - L 40 ½" H 1 ½" W 3"
LED 20W 1227lm



ALPHABETICAL INDEX
DESIGN INTERNO
DESIGN INDOOR



AGAVE

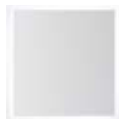

ALDECIMO
110



APP
112



ARENA
2



BELLA
8



BELLA VESTITA
14



BLANCA
114



BROOKLYN LINE
119



BROOKLYN ROUND
119



BROOKLYN SPOT
119



CANDLE
124



CARL
16



CARL2
16



CARMEN
22



CLIO
64



CROSS



DISCO



ELY



EMMA
64



EMY



EVY



FIREFLY IN THE SKY
26



FLAT



FLORAL

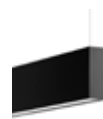

GIANO
128





GILBERT
132



GINEVRA
30



GONIO
35



GOLDEN RING
137



GONG
134



HILOW
40



HILOW LINE
40



JACKIE
50



JACKIE IOT



JAY
54



KUBIK



LINE



LOLA
60



OLIVIA
64



ONE



OPUNTIA
69



PLANET RING
137



SILVER RING
137



SMOKE
78



THREE



TO-BE
144



TOY
146



TOY GYPSO
146



TUBINO
82



TUBINO PLUS
82



DESIGN INTERNO
DESIGN INDOOR



TWISTER



TWO



VIISI
94



VIKI



WILLY ALU
148



WILLY GLASS
148



WILLY XL
148



YPSILON



ZERO
152



ZERO ROUND
99



ZERO ROUND VERTICAL
99



ZERO ELLIPSE
99



ZERO SQUARE
99



ACUSTICA
ACOUSTIC



ARENA ACOUSTIC
2



BIRDCAGE



VAPOR ECHO



ZERO ROUND ACOUSTIC
99



ZIG ZAG



ESTERNO
OUTDOOR



BOX



DRACO



FIREFLY IN THE SKY
26



FOUR



LAMPYRIS



POTTER



RALPH
74



VENEXIA
88



PROFILI
PROFILES



BROADWAY



BRONX
116



BROOKLYN
119



BROOKLYN OUT
119



BROOKLYN ROUND
119



BROOKLYN SPOT
119



BROOKLYN TRIM
119



CORNER
126



GIANO
128



KIPS
56



KIPS ROUND
56



MANHATTAN
62



NOLITA



NOLITA OUT



NOLITA TRIM



NOOK



TRIBECA



PROIETTORI
SPOTLIGHT



JACKIE SPOT



QUEENS



QUEENS 45



QUEENS 25



QUEENS 20



QUEENS 10



SOHO IN
16



SOHO LINE
16



SOHO OUT
16



SOHO S 15
16



SOHO 20
16



SOHO 10
16



SOHO 5
16



INCASSI
RECESSED



CLICK CLACK



EAST



JARVIS



JOE



MARK



MOAI



MOMO



NICK



ROY



STEP BY STEP



TAYLOR



PANZERI

PANZERI CARLO S.R.L.

Via Padania, 8 - 20853
Biassono MB - Italy
Sede Legale:
Via Mameli, 11 - 20851
Lissone MB - Italy
T +39 039 2497483
F +39 039 2497396
panzeri@panzeri.it
export@panzeri.it
panzeri.it

PANZERI & PARTNERS GMBH

Karlsplatz 3 - 80335
München - Deutschland
T +49 89 209 607 40
F +49 89 209 607 41
info@panzeri-partners.de
panzeri-partners.de

PANZERI FRANCE SAS

31 rue Laure Diebold
Parc d'activité Greenopolis
69009 Lyon 09 - France
FR77 889 971 271
jmsa@panzeri-france.fr
panzeri-france.fr

© Panzeri Carlo S.r.l.

AD_Matteo Thun Milano
Premedia_INTOThesign
Photos/Images_INTOThesign
HDG Hangar Design Group
Print_Asolana Group

September 2021

È vietata la riproduzione anche parziale di questo Catalogo
It is forbidden to reproduce any part of this Catalogue

PANZERI.IT