

# DECO

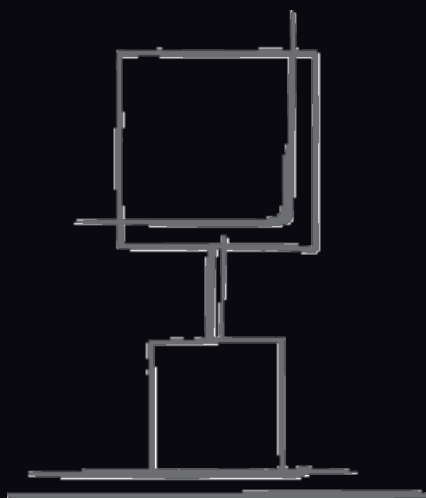

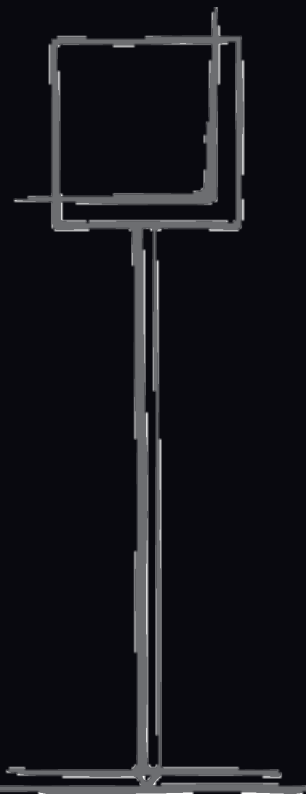

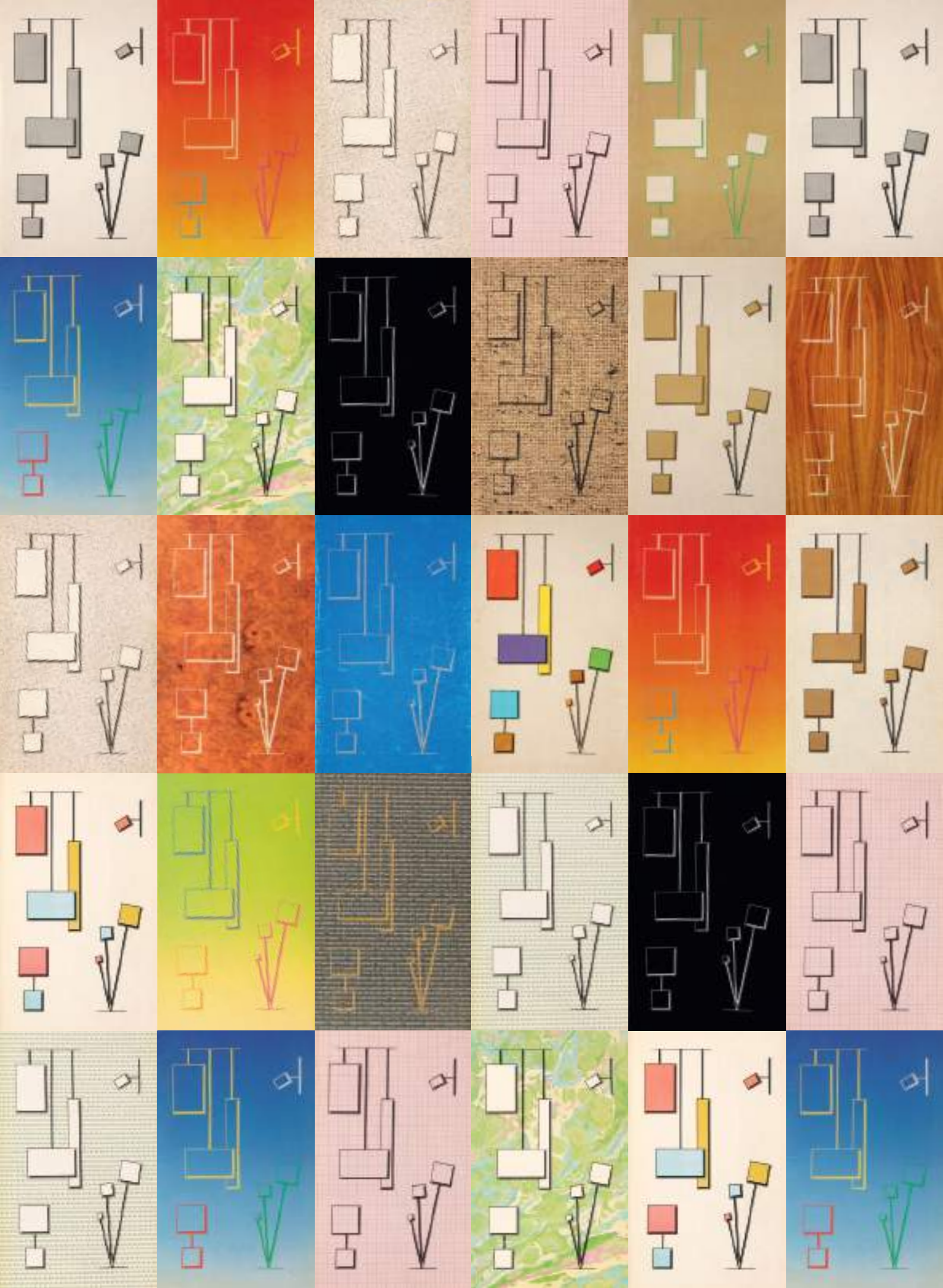
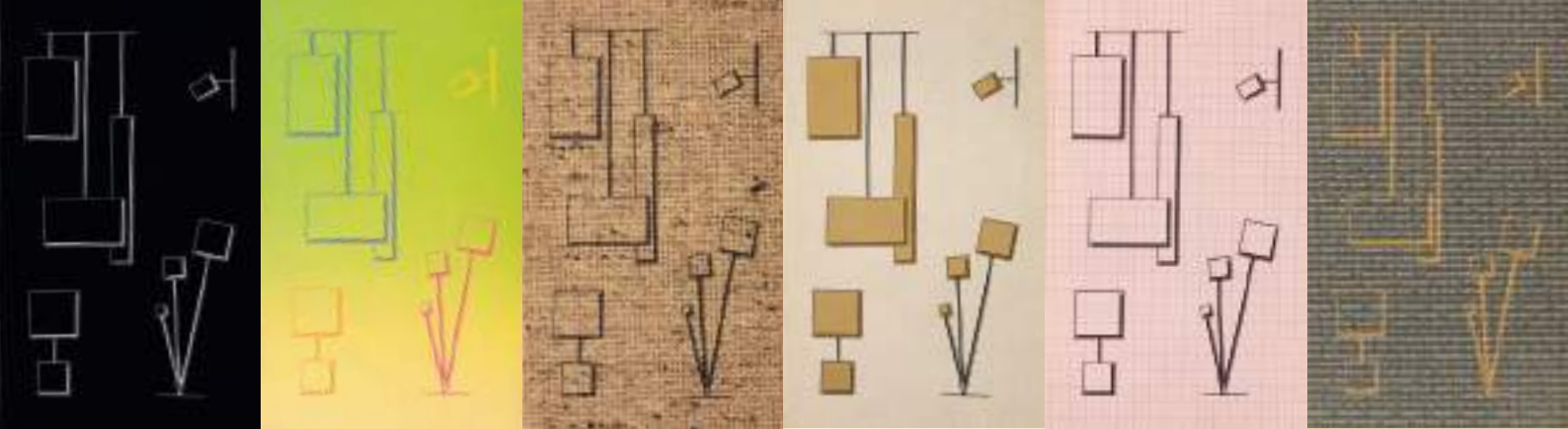

# 90

1929  
2019 ANNI

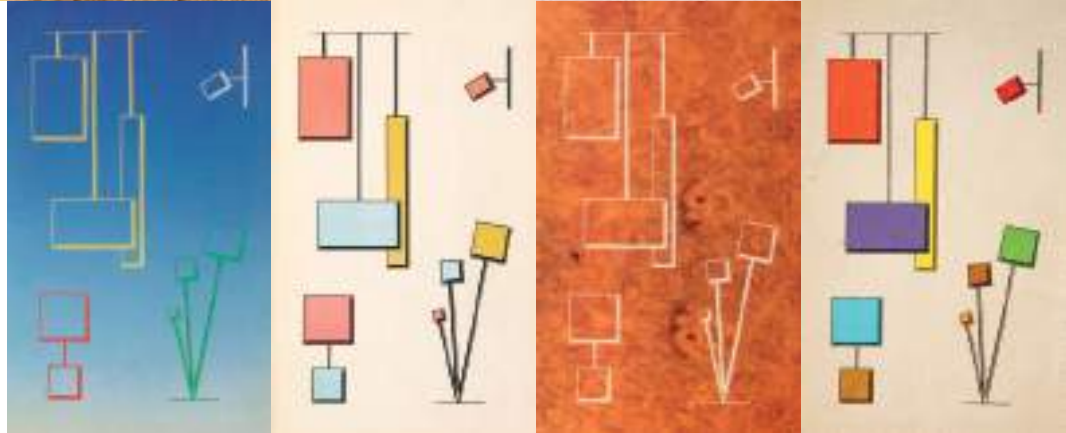

**Il catalogo edizione 90 vuole essere un omaggio ai cataloghi storici che ci hanno accompagnato, dal 1961 ad oggi. In particolare la copertina, con le applicazioni delle lampade disegnate a mano, che raccontano, sin dalla nostra prima edizione cartacea, l'ampia offerta delle nostre lampade. Prodotti adatti ad ogni applicazione (sospensione, soffitto, parete, terra e tavolo).**

**The 90 edition of the catalogue is a tribute to the historical catalogues that followed us, from 1961 until today. In particular the cover, with the applications of hand-drawn lamps, which tell, since our first printed edition, the wide offer of our lamps. Products suitable for every application (suspension, ceiling, wall, floor and table).**

E a voi, qual è la copertina che piace di più, in mezzo a tanti diversi colori? Raccontatecelo con una mail a [marketing2@rossinigroup.it](mailto:marketing2@rossinigroup.it)

And what about you? What is the cover you like most? Tell us at [marketing2@rossinigroup.it](mailto:marketing2@rossinigroup.it)

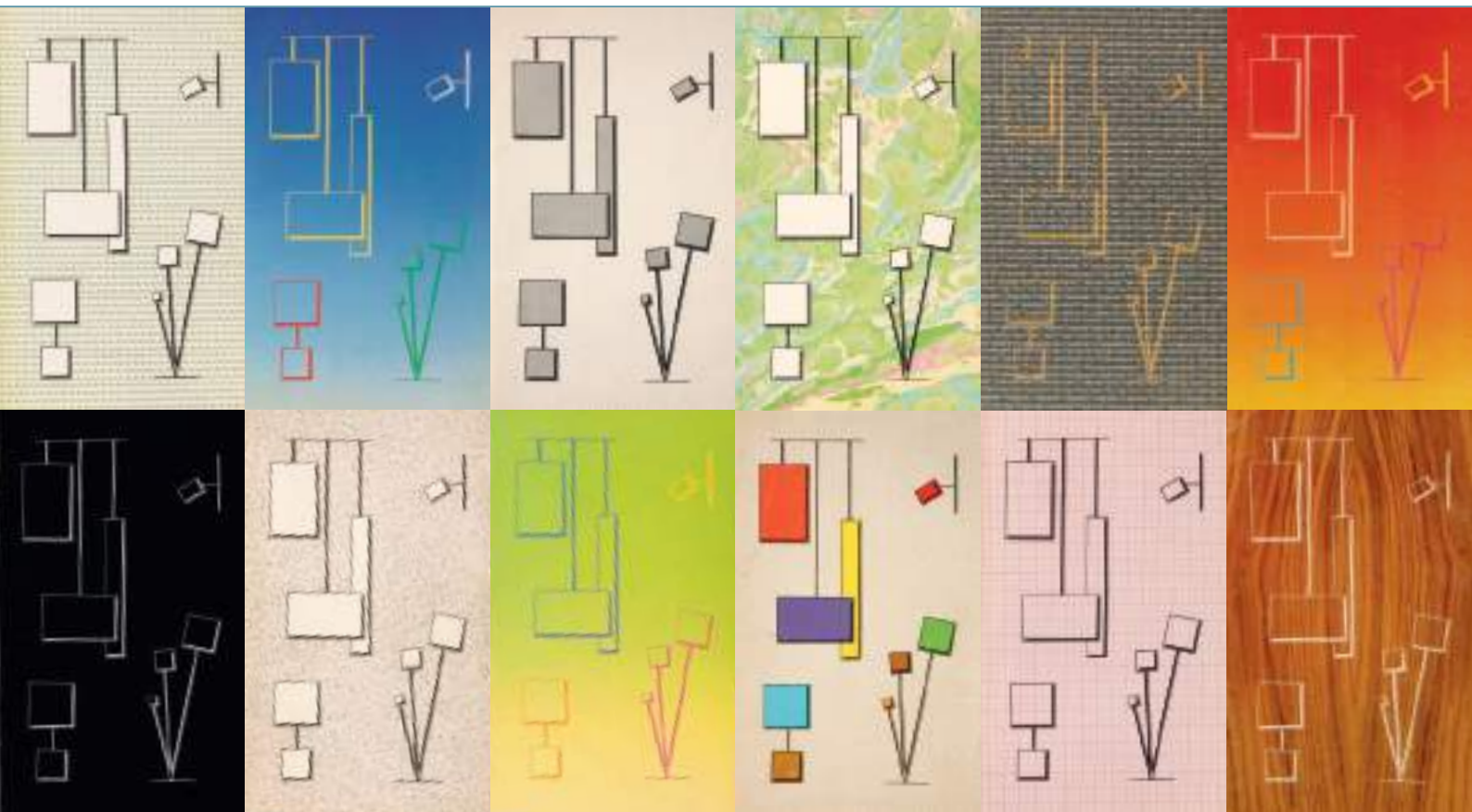

# LA LUCE NEL DNA LIGHT IN THE DNA

Durante la seconda guerra mondiale uno spezzone incendiario distrugge completamente il magazzino e l'attività è costretta ad interrompersi per qualche anno.

During the Second World War an incendiary fragmentation bomb destroys completely the warehouse and the activity is forced to stop for a few years.



Il giovane Eugenio Rossini succede al padre, inaugurando così la seconda generazione alla guida dell'azienda.

The young Eugenio Rossini happens to the father: it is the second generation in control of the company.



Esce il primo catalogo: è composto di sole due facciate e qualche decina di prodotti.

Per la prima volta vengono introdotti nuovi modelli di lampadari che uniscono l'eleganza del vetro artistico di Murano e la solidità della struttura costruita dagli artigiani milanesi.

The first catalogue comes out: it consists of only two pages and a few dozen products. New models of chandeliers are introduced, combining the elegant Murano artistic glass and the solid structure built by the Milanese artisans.



Rossini Illuminazione festeggia 50 anni di solida attività.

Rossini Illuminazione celebrates 50 years of solid activity.

## 1942

## 1929

4 Ottobre 1929: Otello Rossini si trasferisce dal Veneto nel capoluogo lombardo, dando origine a un piccolo commercio di oggetti in vetro. Nel giro di pochi anni la bottega diventa un piccolo negozio in via Melzo: fanno capolino i primi lampadari artistici di Murano.

October 4th, 1929: Otello Rossini moves from Veneto to Milano, starting a small trade of glass objects. Within a few years the tiny atelier becomes a small shop in via Melzo selling artistic chandeliers in Murano glass.



## 1946

Superata la guerra e le difficoltà che ne seguono, Milano e il paese si risolvono e gli affari per Otello Rossini incominciano a prosperare. Si costituisce la "Ditta Rossini Otello".

After the war and the following difficulties, Milano and the country lifts up and for Otello Rossini the business begins to grow. "Rossini Otello Company" is established.

## 1951

## 1950

L'azienda cresce, ha bisogno di una nuova collocazione. Come lo stesso Eugenio afferma "lo spazio è sempre stato un'esigenza primaria nello sviluppo della nostra attività. Ogni volta la nuova superficie sembrava enorme ed ogni volta veniva rapidamente saturata." La sede si sposta in uno spazio di 350 mq con una piccola esposizione.

The company grows. "Space has always been a primary requirement in the development of our activity. Each time the new surface looked huge and each time it was quickly saturated" as Eugenio says. The firm moves to a space of 350 m<sup>2</sup> with a first small exhibition.

## 1960

## 1961



## 1970

1 Gennaio 1970: La ditta "Rossini Otello" diventa "Rossini Illuminazione" e viene inaugurata la nuova sede aziendale in Via Feltrina e suddivisa su 5 piani per una superficie di 6000 mq. La signora Paola, madre di Eugenio, è ancora attivamente presente in azienda.

January 1st, 1970: The company "Rossini Otello" becomes "Rossini Illuminazione". A new headquarter in via Feltrina opens: 5 floors and 6000 m<sup>2</sup> area. Eugenio's mother, Paola, is still present at work.

## 1979

## 1992

## 1994

Eugenio Rossini lascia la direzione operativa dell'azienda al figlio del cugino Angelo, Ruggero Rossini. I figli di Eugenio sono ancora in giovanissima età e Ruggero ha dalla sua un'esperienza già decennale nel settore dell'illuminazione. Il catalogo passa da una cinquantina di pagine alla prima versione da 200 pagine.

Eugenio Rossini leaves the operational direction of the company to the son of his cousin Angelo, Ruggero Rossini. Eugenio's sons are still young and Ruggero benefits from a ten-year experience in the lighting industry. It is the first edition of the "big catalogue", consisting of more than 200 pages.



Nasce Overlite, lo showroom con i top brand nel settore dell'illuminazione di design. La sede è in via Feltre 32, accanto alla sede storica dell'azienda.

Overlite is born, the showroom with the top brands of design luminaires. It opens in via Feltre 32, next to the company's historic headquarters.

Rossini Illuminazione compie 80 anni. La moglie di Eugenio, Maria Angela, assume la presidenza della società, affidando la direzione operativa ad un manager esterno. Tre dei quattro figli di Eugenio entrano in azienda, imparando il mestiere dalle basi: la vendita e la gestione del magazzino.

Rossini Illuminazione celebrates 80 years. Eugenio's wife, Maria Angela, is the new president of the company, and she entrusts an external manager with the operational direction. Three of the four sons of Eugenio join the company, learning the business from the basics: the sale and management of the warehouse.



Esce il catalogo Rossini Illuminazione per la prima volta suddiviso in volume DECO e TECH. La scelta è dettata dalla necessità di aggiornamenti sempre costanti, basati sull'evolversi della tecnologia che connota il settore dalla comparsa e sviluppo dei LED.

The Rossini Illuminazione catalogue is published for the first time divided into two editions: DECO and TECH. The choice was driven to offer constant updates, since the introduction and development of LEDs and consequent evolution of technologies.



Rossini illuminazione raggiunge l'importante traguardo dei 90 anni, un 90° anniversario che si legge "nove-punto-zero". Una celebrazione del passato con uno sguardo rivolto al futuro, attraverso i progetti legati all'internazionalizzazione e allo sviluppo continuo della tecnologia LED, per un nuovo concetto di luce che pone al centro la persona, i suoi bisogni e il suo benessere.

Rossini illuminazione turns 90 years old. Our 90th anniversary becomes "Nine-Point-Zero": a celebration of our past origins and a look to the future, ready for the next challenges of internationalization and continuous development of LED technology, for a new concept of light that it is especially meant for human being.

1996

La sede dell'azienda passa a Segrate (Milano) in una struttura di 8400 mq completamente informatizzata che permette la gestione in stock di tutte le referenze, arricchita da un'ampia sala esposizione.

The company's headquarters moves in Segrate (Milano) in a fully computerized 8400m<sup>2</sup> structure that allows the stock management of all references, enriched by a large exhibition room.



2001

2004

L'azienda si dota per la prima volta di una nuova e strutturata rete commerciale di agenti e di un direttore commerciale. Nello stesso anno, Rossini Illuminazione subisce la perdita di Eugenio Rossini.

The company develops a new and solid commercial network of sales representatives managed by a commercial director. In the same year, Eugenio Rossini passes out.

2009

## Plexiform®

SOLUZIONI IN LUCE

2012

Rossini illuminazione acquisisce Plexiform, un'azienda milanese con una storia e un'esperienza consolidata di quasi 50 anni e già partner affidabile di Rossini. L'intenzione è avere sotto controllo il processo produttivo degli apparecchi.

Rossini Illuminazione acquires Plexiform, a lighting company based in Milano with a history and a consolidated experience of almost 50 years and already partner of Rossini. The aim is to manage the production process of the fittings.

2016



2016

È l'anno zero: i fratelli Rossini (Dario, Marco, Elisa) assumono a tutti gli effetti la direzione operativa del gruppo, pur continuando ad occuparsi delle rispettive aree di competenza: ufficio acquisti, finanza e controllo, marketing e comunicazione.

It is the Year Zero: the Rossini brothers (Dario, Marco, Elisa) take over the operational direction of the group, while continuing to take care of their respective areas of competence: purchasing, finance and control, marketing and communication department.

2019

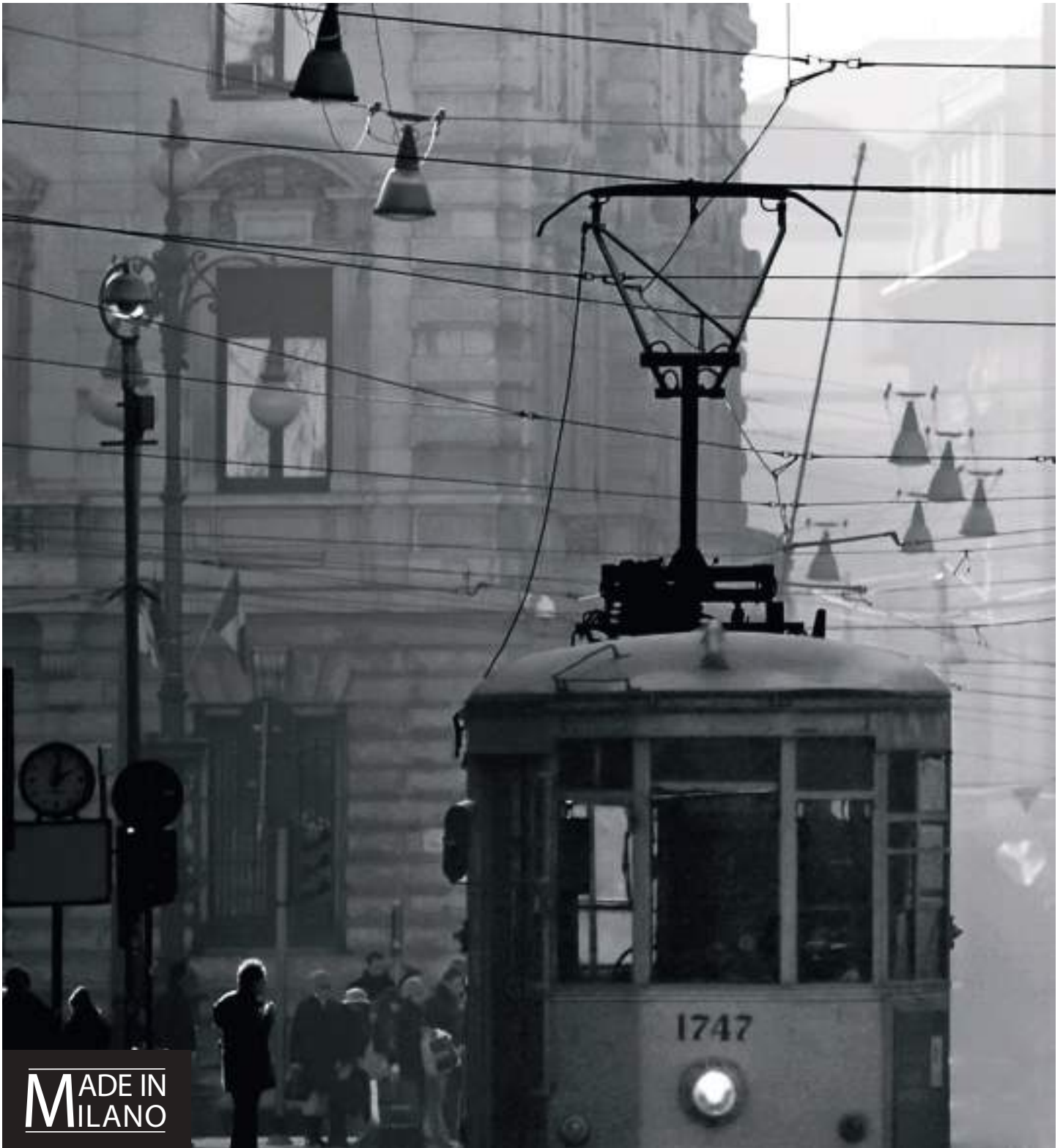

**MADE IN  
MILANO**

#### **Made in Milano, ovvero Made in Italy**

La nostra è una storia familiare che si sviluppa in un Paese che vanta molteplici eccellenze, non ultime quelle produttive. **L'amore per Milano e la presenza sul territorio milanese hanno sempre contraddistinto la nostra storia.** Per questo abbiamo voluto creare il logo Made in Milano, rendendo omaggio a Milano, che sta diventando sempre più un «marchio di qualità»: in continua evoluzione, trendy senza perdere le sue radici, internazionale ma profondamente italiana, positiva e generosa.

Il logo evidenzia i prodotti **interamente concepiti, realizzati ed assemblati in Italia** grazie a partnership produttive privilegiate che trasferiscono all'Azienda tutta la qualità e il know-how tecnico proprio dell'eccellenza italiana.

#### **Made in Milano, or Made in Italy**

Ours is a family history that grows in a country that boasts many excellences, not least the productive ones. **Our love for Milano and our presence in the Milanese area have always characterized our history.** This is why we wanted to create the Made in Milano logo, paying tribute to this city, which is increasingly becoming a "quality brand": constantly evolving, trendy without losing its roots, international but profoundly Italian, positive and generous.

The logo highlights the products entirely **conceived, manufactured and assembled in Italy** thanks to privileged productive partnerships that transfer all the quality and technical know-how of Italian excellence to the Company.



**Made in Murano, ovvero Made in Veneto**

L'eccellenza italiana non dimentica la produzione artigianale del nostro Paese. Da sempre presente all'interno della nostra offerta, oggi vogliamo evidenziare l'ampiezza della gamma realizzata in Veneto. Il logo Made in Murano accomuna tutti i prodotti realizzati in collaborazione con la manifattura veneta, siano questi moderni o dal gusto classico.

Tutti vetri artigianali soffiati a mano dai mastri vetrai veneziani, che danno vita a lampade senza tempo e che hanno ancora il sapore artigianale dei prodotti fatti a mano. Oggi come allora, dal 1929.

**Made in Murano, or Made in Veneto**

Italian excellence does not forget the craft production of our country. Always present within our offer, today we want to highlight the wide range of products created in Veneto. The Made in Murano logo connects all the lamps made in collaboration with the Venetian manufacture, whether these are modern or classic.

These are all hand-blown glass made by Venetian glass masters, who give life to timeless lamps that still have the artisan taste of handmade products. Today as then, since 1929.

# DESIGNER



**Chiaramonte & Marin**  
Terrazza Martini

*“La forma tondeggiante di un’oliva e il classico aperitivo milanese: ecco gli ingredienti per nome e forma di questa lampada, la rivisitazione di una sfera senza tempo in chiave moderna e tecnologica”.*

*“The rounded plump olive and the classic Milanese aperitif: these are the ingredients by name and form of this lamp, the revisitation of a timeless sphere in a modern and technological key”.*

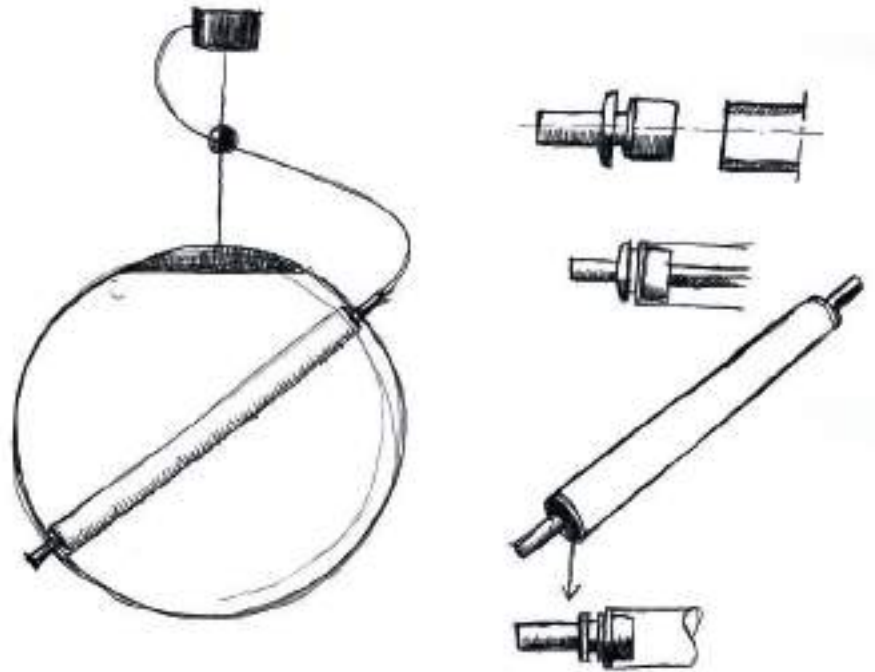

**Jurre Groenenboom**  
Karaoke

Prende spunto dalla forma del microfono ed è un prodotto molto versatile che si presta a personalizzazioni da parte dell’utente, con un effetto materico dell’ottone spazzolato particolarmente ricco ed elegante.

It is inspired by the shape of the microphone and is a very versatile product that lends itself to customization by the user, with a particularly rich and elegant material effect or brushed brass.

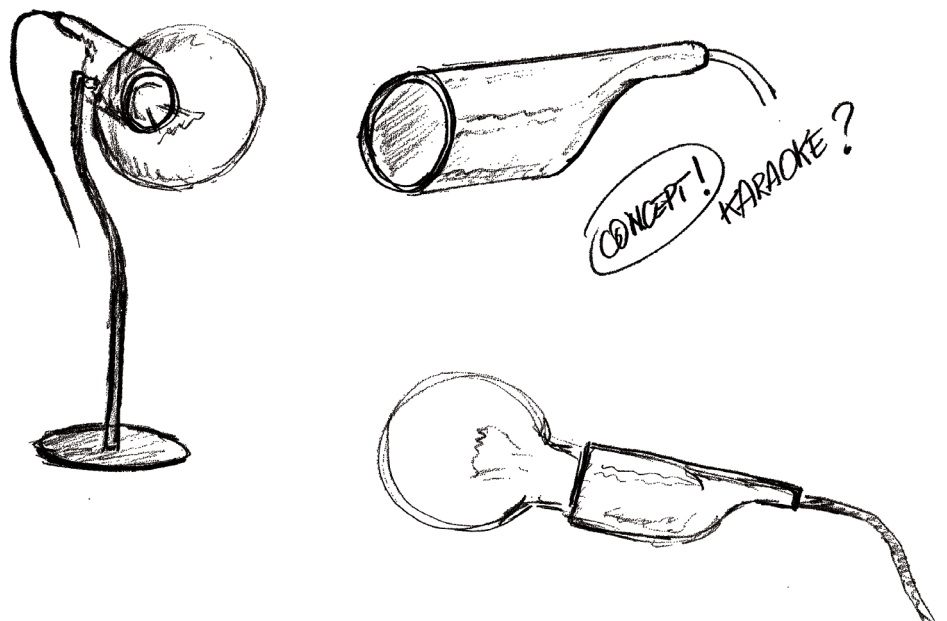



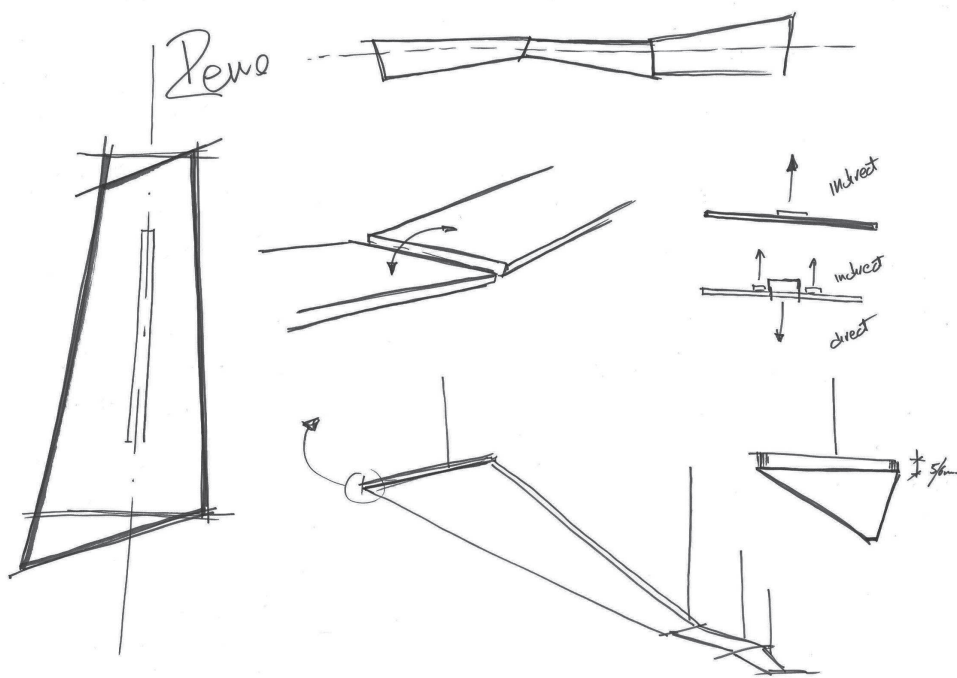

**Stefano Valente**  
Remo

Un designer comasco non poteva che ispirarsi ad un elemento lacustre come quello di un remo, che in questo caso fluttua nell'aria e con la sua forma asimmetrica movimentata lo spazio e l'ambiente.

A designer from Como could not but be inspired by a lake element like that of an oar, which in this case fluctuates in the air and with its asymmetrical shape moves space and the environment.

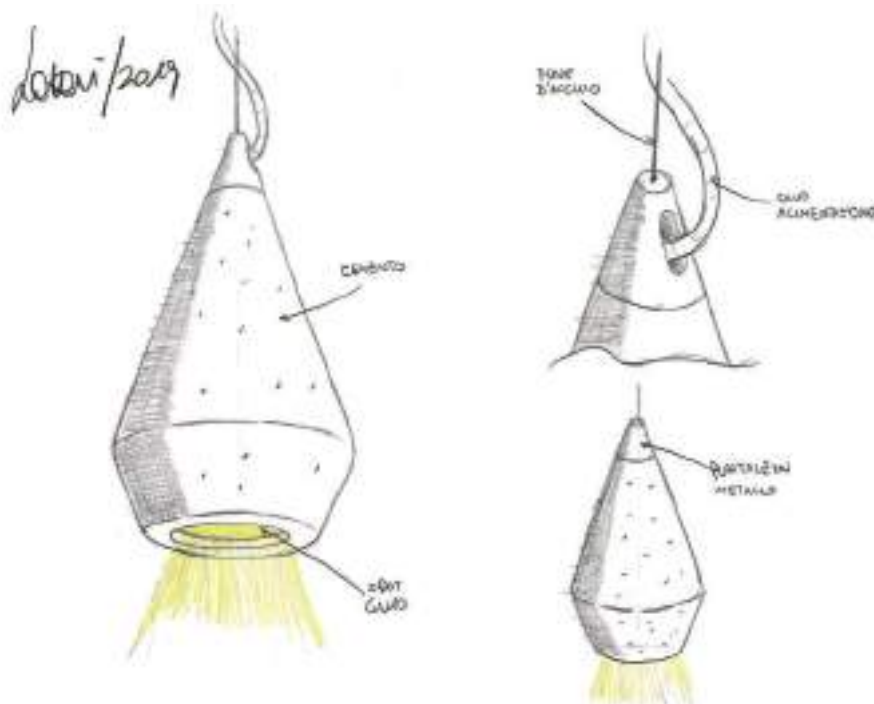

**Andrea Lazzari**  
Pavè

"Il volume pieno del cemento, la concretezza milanese e l'attenzione per il dettaglio. Questi gli ingredienti che mi hanno ispirato per la sospensione Pavè".

"The full volume of the cement, the Milanese concreteness and the attention to detail. These are the ingredients that inspired me for the Pavè suspension".

# COLLECTION 9.0







Rossini Illuminazione oggi offre anche la possibilità di una **personalizzazione completa e di alta qualità** dei prodotti decorativi sia in stile classico che moderno, dando ai propri clienti la possibilità di **personalizzare la dimensione**, la **finitura** della lampada scelta, la **struttura del lampadario** o la **temperatura colore del LED**.

Un ufficio tecnico completo, strumentazioni all'avanguardia che permettono il perfezionamento ingegneristico delle lampade e consolidati asset produttivi consentono di realizzare soluzioni integrate che fanno di Rossini Illuminazione il **partner ideale anche per il mondo contract**, perché ogni progetto è unico e va sviluppato su misura.

**Cerca il simbolo Custom made all'interno del catalogo e contatta il nostro ufficio commerciale per le tempistiche di fornitura.**

Rossini Illuminazione today offers the possibility of a **complete and high quality customization** of its decorative lamps both in classic and modern style, offering its customers the possibility of **customizing the size**, the **finish** of the chosen lamp, the **structure of the chandelier** or the **color temperature of the LED**.

A complete technical office, state-of-the-art equipment that allows the engineering refinement of lamps and consolidated production assets make it possible to create integrated solutions that make Rossini Illuminazione the **ideal partner also for the contract business**, because each project is unique and must be developed tailored up.

**Look for the Custom made symbol in the catalogue and contact our sales department for delivery times.**

# LA LUCE DIVENTA SMART LIGHT BECOMES SMART

## CASAMBI

Grazie alla tecnologia Casambi, **la luce Rossini diventa davvero intelligente e interattiva**: è l'avvento dell'Internet Of Things.

**Con questo sistema le possibilità sono innumerevoli**: con un'interfaccia semplice e intuitiva è possibile collegare e poi controllare i vari apparecchi illuminanti, gestendo l'accensione o spegnimento, l'intensità luminosa o il colore della luce, configurando anche **diversi scenari luminosi a seconda del momento della giornata, dell'attività o dell'esigenza personale**.

Thanks to Casambi, **Rossini light becomes really smart and interactive**: that's the Internet of Things.

**With this lighting system the possibilities are endless**: the App, thanks to an extremely user-friendly aspect, can easily connect different lighting devices. The luminaires can communicate with each other: turning on/off, dimming and varying the colour output. **Different scenes can be preset, to create the perfect light on every occasion**.

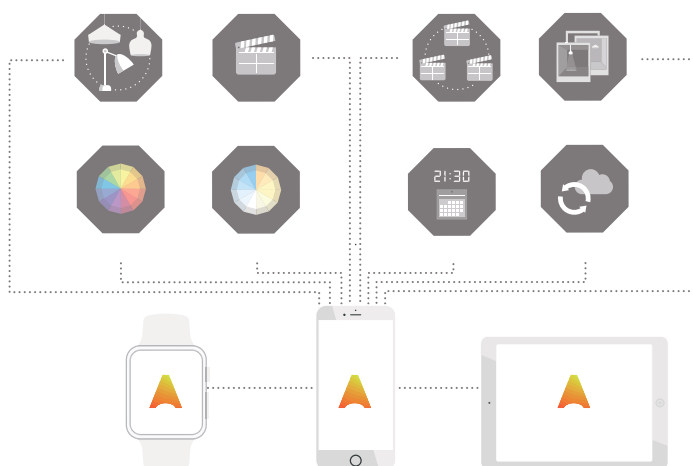

La luce connessa oggi è alla portata di tutti. **La tecnologia smart integrata** viene proposta su nuovi apparecchi a LED e nuove lampadine LED che funzionano con qualsiasi portalampada standard. **Anche in assenza di predisposizione di un impianto domotico**, è possibile rendere l'ambiente davvero unico e personalizzato.

Grazie all'integrazione completa con le app Google Assistant e Amazon Alexa, **è possibile gestire la luce** attraverso i propri device **con il solo suono della propria voce**.

Connected light today is within everyone's reach. **The smart technology** is available for new LED luminaires and LED lamps that work with any standard lamp holder. **Even in the absence of a home automation system**, it is now possible to have your room truly unique and personalized.

Thanks to the complete integration with the Google Assistant and Amazon Alexa apps, **it is possible to manage the light** through your own devices **with the sound of your own voice**.



App Control



L.283-6-27KWF



L.959-6-27K-WF



La luce diventa funzionale ed è al servizio della persona.  
Una luce che ama il suo fruitore.

Light becomes functional and it's meant for human being.  
It's human-centric lighting.



Rossini Illuminazione dispone di un servizio di spedizione estremamente rapido che garantisce la consegna presso il cliente in Italia in 24-48 ore lavorative.

Rossini Illuminazione offers an extremely fast delivery service that guarantees delivery to the customer based in Italy within 24-48 working hours.



Tanti i rinnovamenti proposti con questa nuova edizione DECO. Molti i prodotti **NEW**, novità assolute. Ben 48 famiglie per la precisione!

Many are the product updates proposed with this new DECO edition. Many **NEW** are absolute novelties. 48 families to be precise!

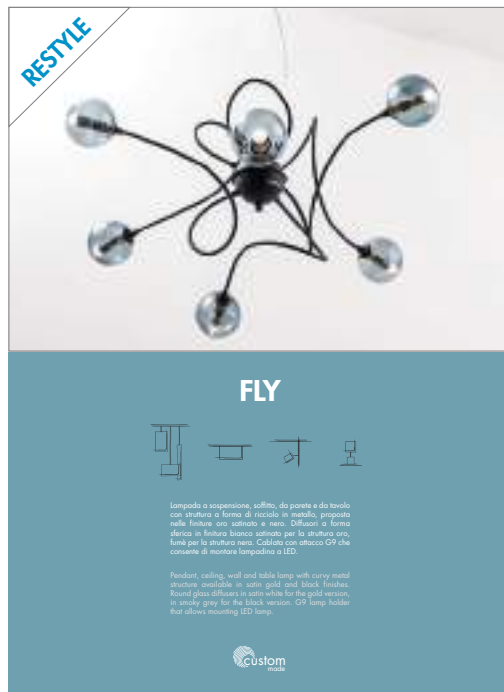

Ancora di più i prodotti che identifichiamo con il logo **RESTYLE**: ampliamenti di gamma, rivisitazioni di prodotti best seller già presenti nella nostra offerta; nuove finiture colore, nuove dimensioni o applicazioni. Per un totale di ben 70 famiglie!

Even more the products that we identify with the **RESTYLE** logo: range extensions, reviews of best seller already present in our offer; new color finishes, new dimensions or applications. For a total of 70 families!

# GUIDA ALLA LETTURA READING GUIDE

Con questa nuova edizione DECO vi offriamo anche un servizio in più: **dimensioni della lampada indicate in fotografia**, per una lettura più immediata e facile. Accompagnate, per le sospensioni, dalle **dimensioni del rosone e dalla lunghezza del cavo** che troverete in tabella. Per una scelta ancora più ragionata e accompagnata.

With this new DECO edition, we also offer an extra service: **lamp sizes shown in the pictures**, for an immediate and easier reading. Moreover, by the suspension, the **size of the ceiling rose and the length of the cable** are quoted in the table. For a more accurate and facilitated selection.

## ESEMPIO COMPOSIZIONE CODICE EXAMPLE OF THE CODE COMPOSITION



## SIMBOLI DIMMERAZIONE DIMMABLE SYMBOL

-  PUSH DIMMER
-  TAGLIO DI FASE PHASE CUT
-  TOUCH DIMMER
-  VARIALUCE DIMMER
-  DALI

## FLUSSO FLUX

I lumen indicati nella tabella tecnica sono tutti nominali.  
The lumens shown in the technical chart are all nominal.

## K - TEMPERATURA LUCE COLOUR TEMPERATURE

I nostri prodotti LED sono presentati con temperatura di colore calda (2700K o 3000K).

Our LED luminaires are equipped with warm white colour temperature (2700K or 3000K).

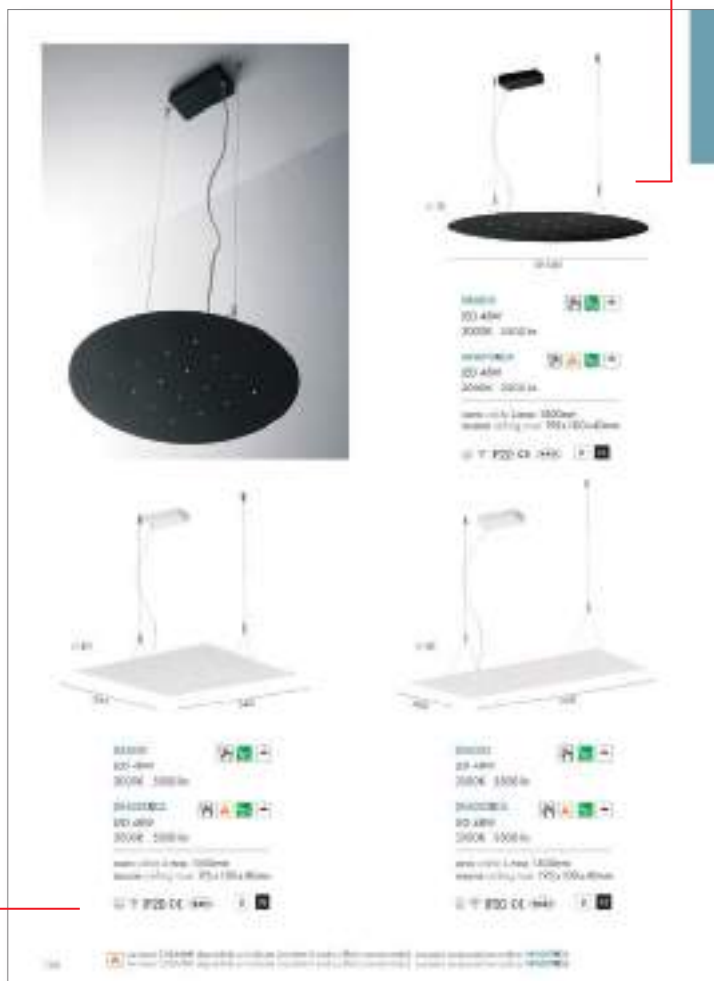

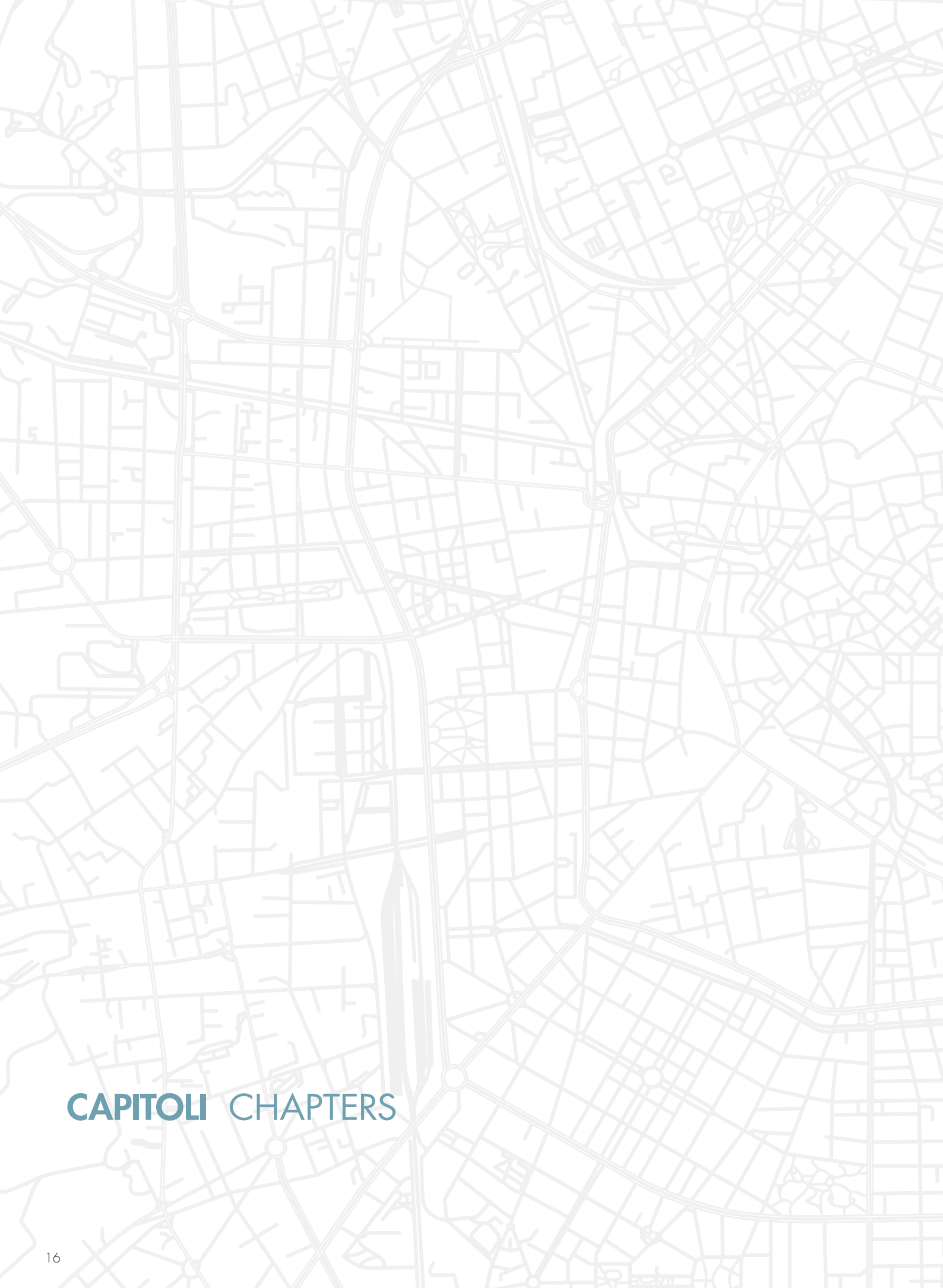

# CAPITOLI CHAPTERS



DECORATIVO MODERNO 41  
MODERN DECORATIVE

DECORATIVO CLASSICO 589  
CLASSIC DECORATIVE

LAMPADE DA ESTERNO 675  
OUTDOOR

LAMPADE DA BAGNO 699  
BATHROOM LIGHT

VENTILATORI 715  
PADDLE FAN

ACCESSORI 723  
ACCESSORIES

# INDICE ALFABETICO

## ALPHABETICAL INDEX

ABIKA	706	CAMBRIA	383	FRINGE	115
ACABA	520	CANDICE	672	GEORGIA	480
ACE	565	CAROLINE	598	GIGLIO	660
AISHA	399	CARRIE	261	GIOIA	231
ALBATROS	555	CHANDRA	562	GLENN	341
ALDRIN	366	CHOPIN	131	GLORIA	349
ALICE	666	CILEA	655	GOGOL	540
ALLEN	518	CLAIRE	331	GRACE	357
ALTEA	710	COLLINS	368	GRECALE	716
AMANDA	623	CORVINA	295	GRETA	337
AMARAL	601	CRYSTAL	55	GRIP	478
AMELIE	554	CURL	251	HARPER	440
ANNETTE	664	CURTIS	560	HOLDEN	408
ARDBEG	211	DAISHO	193	HOLE	564
ARGO	144	DARRYL	443	HOLLY	345
ARGO PLASTER	148	DAVID	472	iGLOO	43
ARIAL	464	DONNA	522	IKU	155
ASIA	137	DRAM	161	INGRID	570
ASTRID	497	DRAW	264	IPANEMA	289
AUDREY	292	DRILL	438	ISAKO	288
AUSTIN	470	DRIVE	474	JARVIS	667
AXIOM	127	DUFFY	434	JAY	93
BALA	206	DYLAN	707	JENNY	543
BALOS	578	EDITH	457	JESSICA	606
BALZAC	508	ELENA	718	JOHN	550
BARNEY	484	ELLIS	487	JUDY	354
BEK	410	ELMER	432	JULIA	380
BELL	267	ELONIA	708	KAHLO	173
BEN	208	EMILY	311	KALERY	567
BENOIT	482	EMPTY	89	KARAOKE	77
BESANA	307	ENSO	199	KAREN	649
BIANCA	696	ERIN	284	KATHY	323
BINNIE	501	ERKEL	103	KAWA	558
BLUMEA	711	FARIS	371	KEATS	453
BOLSHOI	611	FELICE	640	KLAUS	449
BOND	556	FELIX	673	KOFI	374
BONNY	390	FENICE	658	LA SCALA	591
BRENDA	532	FLORAL	626	LEIKA	109
BUBBLES	181	FLY	301	LEILA	393
BYRON	417	FOLKS	506	LIBBY	662
CALEB	551	FRANCIS	661	LINA	422
CALLA	247	FREDDY	455	LIND	510

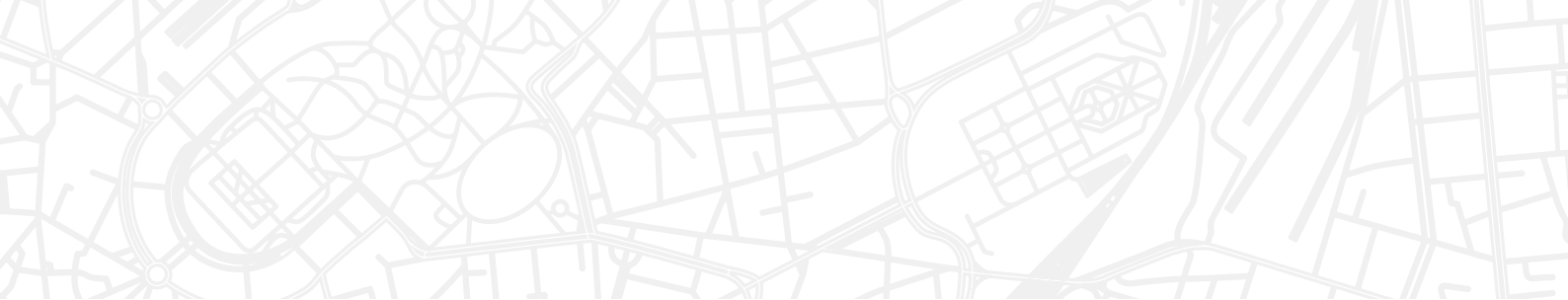

LOTUS	151	PUZZLE	169	TURATI	277
LUKE	643	RAVEL	436	TWIN	69
LYNETTE	618	READ	700	UMA	403
MACBETH	596	REGIO	635	VIOLINA	615
MAGDA	546	REMO	61	VITTORI	427
MAGO'	549	RENOIR	377	VIVIEN	413
MARILYN	319	RIFLESSI	243	WALT	694
MEG	237	ROMAN	542	WANG	112
MELARA	582	ROYAL	608	WEDGE	189
MELBA	462	RUNAK	326	WENDY	665
MELTEMI	717	SALLY	406	WESS	493
MELVIN	580	SALOME'	638	YUCCA	548
MEREDITH	632	SANCHO	273	ZED	712
METROPOLITAN	629	SAND	468	ZIG ZAG	270
MILETO	364	SAYA	702		
MILLA	573	SCILLA	552		
MINI AXIOM	123	SCRAT	537		
MINX	387	SERENA	668		
MOODY	460	SHELL	255		
MORI	513	SID	534		
MYRIAD	466	SIESTA	681		
NELSON	452	SIPLE	530		
NEMO	705	SMOOTH	158		
NERELLO	420	SNAP	411		
NICKY	670	SODDY	584		
OBAN	217	SOPHIA	361		
OFU	281	SPINNAKER	165		
OPTIMA	454	SUNSET	203		
ORBIT	97	SYRAH	576		
PARAISO	298	TAKE AWAY	687		
PARK	544	TAKE AWAY SOUND	691		
PAVÈ	66	TALISKER	223		
PEGGY	290	TASCA	424		
PERLA	527	TASHA	328		
PIAF	586	TAYLOR	704		
PIC-NIC	677	TERRAZZA MARTINI	51		
PICOLIT	286	TESLA	446		
PIPER	709	TITO	516		
PLAYA	489	TOM	486		
POLO	430	TOOL	431		
POM	524	TRICIA	720		
PONYO	185	TSUKI	85		

	PG.	ZONA GIORNO LIVING AREA	ZONA NOTTE SLEEPING AREA	CUCINA KITCHEN	BAGNO BATHROOM	CAMERA BIMBI CHILDREN'S ROOM	STUDIO STUDY	OUTDOOR	HOSPITALITY	RETAIL	LED	ATTACCO TRADIZIONALE TRADITIONAL LAMP HOLDER	DIMMERABILE DIMMABLE	CUSTOM MADE
ACABA	520	•			•		•		•			•		
ACE	565						•				•			
AISHA	399	•					•		•	•				
ALBATROS	555	•					•					•		
ALDRIN	366	•	•	•								•		
ALLEN	518	•			•		•					•		
AMELIE	554	•				•			•			•		
ARDBEG	211	•	•						•			•		
ARGO	144	•	•	•	•		•		•	•		•		•
ARGO PLASTER	148	•	•	•	•		•		•	•		•		
ARIAL	464	•	•		•		•		•			•		
ASIA	137	•	•	•					•			•		
ASTRID	497	•	•	•	•		•				•		•	•
AUDREY	292	•		•							•			
AUSTIN	470	•	•						•		•		•	
AXIOM	127	•	•	•	•		•		•	•	•	•		•
BALA	206	•	•		•		•		•		•		•	•
BALOS	578			•	•						•			
BALZAC	508	•	•	•	•		•	•	•	•	•	•		
BARNEY	484	•	•	•	•	•	•		•	•	•	•		
BEK	410	•		•			•			•		•		
BELL	267	•		•								•		
BEN	208	•	•		•	•	•		•		•		•	•
BENOIT	482	•	•	•	•	•	•		•	•		•		
BESANA	307	•	•			•					•			
BINNIE	501	•	•	•	•		•		•		•		•	
BOND	556	•					•		•		•		•	
BONNY	390	•	•	•		•					•			
BRENDA	532	•	•	•			•		•		•		•	
BUBBLES	181	•	•	•	•	•	•			•	•	•	•	•
BYRON	417	•	•				•			•				•
CALEB	551	•							•			•		
CALLA	247	•	•			•	•		•		•		•	
CAMBRIA	383	•		•					•	•		•		
CARRIE	261	•	•			•			•	•		•		
CHANDRA	562		•				•		•		•			
CHOPIN	131	•	•	•		•	•		•	•	•	•		
CLAIRE	331	•		•					•			•		
COLLINS	368	•	•						•		•			
CORVINA	295	•	•	•	•				•	•	•	•		
CRYSTAL	55	•	•	•	•		•		•		•			•
CURL	251	•	•	•		•			•		•			
CURTIS	560	•	•				•		•					

	PG.	ZONA GIORNO LIVING AREA	ZONA NOTTE SLEEPING AREA	CUCINA KITCHEN	BAGNO BATHROOM	CAMERA BIMBI CHILDREN'S ROOM	STUDIO STUDY	OUTDOOR	HOSPITALITY	RETAIL	LED	ATTACCO TRADIZIONALE TRADITIONAL LAMP HOLDER	DIMMERABILE DIMMABLE	CUSTOM MADE
DAISHO	193	•	•			•			•	•				
DARRYL	443	•			•		•					•	•	
DAVID	472	•	•		•		•		•					
DONNA	522	•	•	•					•					
DRAM	161	•		•			•				•			
DRAW	264	•	•			•			•	•				
DRILL	438	•		•	•		•			•				
DRIVE	474	•	•				•		•					
DUFFY	434	•	•	•	•		•		•	•				
EDITH	457	•	•	•	•		•		•		•	•		
ELLIS	487	•		•	•	•			•					
ELMER	432	•	•	•	•	•	•		•	•				
EMILY	311	•	•	•		•	•		•		•			
EMPTY	89	•	•	•		•	•		•					
ENSO	199	•	•			•	•		•	•				
ERIN	284	•		•					•					
ERKEL	103	•	•	•	•	•	•		•	•				
FARIS	371	•					•		•					
FLY	301	•	•	•		•			•	•			•	
FOLKS	506	•	•	•	•		•	•	•	•				
FREDDY	455	•	•		•		•		•	•				
FRINGE	115		•			•	•		•	•				
GEORGIA	480	•	•	•	•	•	•		•	•				
GIOIA	231	•	•	•					•					
GLENN	341	•	•							•		•		
GLORIA	349	•	•	•			•		•					
GOGOL	540	•												
GRACE	356	•	•	•		•			•					
GRETA	337	•	•	•										
GRIP	478	•					•					•		
HARPER	440	•			•		•		•				•	
HOLDEN	408	•		•			•		•					
HOLE	564					•	•							
HOLLY	345	•	•	•					•	•		•		
iGLOO	43	•	•		•		•		•	•		•		
IKU	155	•					•			•	•	•		
INGRID	570	•		•										
IPANEMA	289	•	•			•				•				
ISAKO	288	•		•					•					
JAY	93	•	•	•	•	•	•		•	•				
JENNY	543	•					•							
JOHN	550	•			•									
JUDY	354	•	•						•					

	PG.	ZONA GIORNO LIVING AREA	ZONA NOTTE SLEEPING AREA	CUCINA KITCHEN	BAGNO BATHROOM	CAMERA BIMBI CHILDREN'S ROOM	STUDIO STUDY	OUTDOOR	HOSPITALITY	RETAIL	LED	ATTACCO TRADIZIONALE TRADITIONAL LAMP HOLDER	DIMMERABILE DIMMABLE	CUSTOM MADE
JULIA	380	•	•	•										
KAHLO	173	•	•	•	•		•			•	•	•	•	•
KALERY	567			•		•							•	•
KARAOKE	77	•	•				•		•					•
KATHY	323	•	•						•					
KAWA	558	•	•	•					•					
KEATS	453	•			•		•							
KLAUS	449	•	•	•	•		•	•						
KOFI	374	•	•	•										
LEIKA	109	•	•	•	•	•			•	•				
LEILA	393	•	•	•					•	•				
LINA	422	•	•						•					
LIND	510	•	•	•	•		•		•		•	•		
LOTUS	151	•	•	•			•		•	•	•			
MAGDA	546	•	•	•		•								
MAGO'	549	•	•		•									
MARILYN	319	•	•	•					•					
MEG	237	•	•	•										
MELARA	582	•	•	•										•
MELBA	462	•	•						•		•	•		
MELVIN	580	•		•										•
MILETO	364	•	•	•					•		•	•		
MILLA	573	•	•	•										
MINI AXIOM	123	•	•	•			•		•	•	•			•
MINX	387	•	•	•	•	•								
MOODY	460	•	•	•	•		•		•		•	•		
MORI	513	•		•					•		•	•		
MYRIAD	466	•	•		•		•		•		•	•		•
NELSON	452	•	•	•	•		•		•		•	•		•
NERELLO	420	•	•	•		•			•		•	•		•
OBAN	217	•	•						•					
OFU	281	•		•					•					
OPTIMA	454	•			•		•		•	•	•	•		
ORBIT	97	•		•					•	•	•			
PARAISO	298	•	•	•		•			•					
PARK	544	•		•					•					
PAVÈ	66	•	•	•					•					
PEGGY	290	•		•		•			•	•	•	•		
PERLA	527	•	•	•	•		•		•	•	•	•		
PIAF	586	•		•		•			•					
PICOLIT	286	•		•					•					
PLAYA	489	•	•		•		•							•
POLO	430	•	•	•	•		•		•	•	•	•		

	PG.	ZONA GIORNO LIVING AREA	ZONA NOTTE SLEEPING AREA	CUCINA KITCHEN	BAGNO BATHROOM	CAMERA BIMBI CHILDREN'S ROOM	STUDIO STUDY	OUTDOOR	HOSPITALITY	RETAIL	LED	ATTACCO TRADIZIONALE TRADITIONAL LAMP HOLDER	DIMMERABILE DIMMABLE	CUSTOM MADE
POM	524	•	•	•	•		•	•			•			
PONYO	185	•	•	•	•		•				•	•	•	
PUZZLE	169	•	•	•	•	•	•				•			
RAVEL	436	•	•		•	•	•		•		•			
REMO	61	•					•		•	•	•	•	•	
RENOIR	377	•	•	•					•	•	•			
RIFLESSI	243	•	•			•					•	•		
ROMAN	542	•					•				•			
RUNAK	326	•	•	•	•	•					•			
SALLY	406	•		•			•		•	•	•			
SANCHO	273	•			•	•			•	•	•		•	
SAND	468	•	•	•	•		•		•	•	•	•		
SCILLA	552	•	•	•		•					•			
SCRAT	537	•	•	•	•				•		•	•		
SHELL	255	•	•	•	•	•			•		•			
SID	534	•	•	•	•						•			
SIPLE	530	•	•	•	•		•		•		•			
SMOOTH	158	•		•			•			•	•	•		
SNAP	411	•		•			•		•		•			
SODDY	584	•		•							•			
SOPHIA	361	•	•				•				•			
SPINNAKER	165	•	•	•	•	•	•				•			
SUNSET	203	•	•			•	•		•		•			
SYRAH	576	•		•	•						•			
TALISKER	223	•	•		•				•		•			
TASCA	424	•	•			•			•		•			
TASHA	328	•	•			•				•	•			
TERRAZZA MARTINI	51	•	•						•		•	•		
TESLA	446	•	•		•				•	•	•	•		
TITO	516	•	•		•		•		•		•			
TOM	486	•		•	•		•			•	•			
TOOL	431	•	•	•	•		•		•	•	•			
TSUKI	85		•			•	•		•		•			
TURATI	277	•	•						•		•			
TWIN	69	•	•		•		•		•		•		•	
UMA	403	•		•			•		•	•	•			
VITTORI	427	•	•			•	•		•	•	•			
VIVIEN	413	•	•				•		•	•	•	•		
WANG	112	•	•	•	•	•			•	•	•			
WEDGE	189	•	•	•	•	•	•			•	•	•	•	
WESS	493	•	•	•	•		•		•		•		•	
YUCCA	548	•	•		•						•			
ZIG ZAG	270	•	•	•		•			•		•			

**DECORATIVO  
CLASSICO**  
CLASSIC  
DECORATIVE

	PG.	ZONA GIORNO LIVING AREA	ZONA NOTTE SLEEPING AREA	CUCINA KITCHEN	BAGNO BATHROOM	CAMERA BIMBI CHILDREN'S ROOM	STUDIO STUDY	OUTDOOR	HOSPITALITY	RETAIL	LED	ATTACCO TRADIZIONALE TRADITIONAL LAMP HOLDER	DIMMERABILE DIMMABLE	CUSTOM MADE
ALICE	666	•	•						•					
AMANDA	623	•	•						•				•	
AMARAL	601	•	•						•				•	
ANNETTE	664	•	•						•					
BOLSHOI	611	•	•				•	•	•					
CANDICE	672	•		•										
CAROLINE	598	•	•						•	•			•	
CILEA	655	•	•	•					•					
FELICE	640	•	•						•					
FELIX	673	•		•	•									
FENICE	658			•	•									
FLORAL	626	•	•						•				•	
FRANCIS	661	•	•	•					•					
GIGLIO	660	•	•	•					•					
JARVIS	667	•	•	•					•					
JESSICA	606	•	•						•					
KAREN	649	•		•					•					
LA SCALA	591	•	•						•				•	
LIBBY	662	•	•						•					
LUKE	643	•		•					•					
LYNETTE	618	•	•	•	•				•				•	
MACBETH	596	•	•						•				•	
MEREDITH	632	•	•						•				•	
METROPOLITAN	629	•	•						•				•	
NICKY	670			•					•					
REGIO	635	•	•	•					•					
ROYAL	608	•	•						•					
SALOME'	638	•	•	•					•					
SERENA	668	•	•						•					
VIOLINA	615	•							•	•			•	
WENDY	665	•	•						•					



## LAMPADE DA ESTERNO OUTDOOR

	PG.	ZONA GIORNO LIVING AREA	ZONA NOTTE SLEEPING AREA	CUCINA KITCHEN	BAGNO BATHROOM	CAMERA BIMBI CHILDREN'S ROOM	STUDIO STUDY	OUTDOOR	HOSPITALITY	RETAIL	LED	ATTACCO TRADIZIONALE TRADITIONAL LAMP HOLDER	DIMMERABILE DIMMABLE	CUSTOM MADE
BIANCA	696	•						•			•			
PIC-NIC	677		•					•			•			
SIESTA	681		•					•			•			
TAKE AWAY	687					•		•			•			
TAKE AWAY SOUND	691					•		•			•			
WALT	694	•	•		•		•	•	•		•		•	

## LAMPADE DA BAGNO BATHROOM LIGHT

ABIKA	706	•			•						•		
ALTEA	710				•						•		
BLUMEA	711				•						•		
DYLAN	707	•			•				•	•	•		
ELONIA	708	•			•				•		•		
NEMO	705	•			•				•		•		
PIPER	709	•			•				•		•		
READ	700	•		•	•		•		•		•		
SAYA	702	•			•				•		•		
TAYLOR	704	•			•				•		•		
ZED	712				•						•		

## VENTILATORI PADDLE FAN

ELENA	718	•	•	•					•		•		
GRECALE	716	•	•	•					•		•		
MELTEMI	717	•	•	•					•		•		
TRICIA	720	•	•	•					•		•		

# DECORATIVO MODERNO MODERN DECORATIVE

NEW

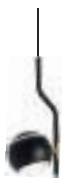

iGLOO  
p.43

NEW



TERRAZZA MARTINI  
p.51

NEW



CRYSTAL  
p.55

NEW



REMO  
p.61

NEW



PAVÈ  
p.66

NEW



TWIN  
p.69

NEW



KARAOKE  
p.77

NEW



TSUKI  
p.85

NEW



EMPTY  
p.89



JAY  
p.93

NEW

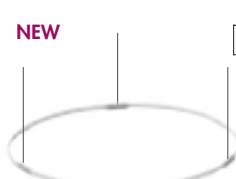

ORBIT  
p.97



ERKEL  
p.103



LEIKA  
p.109



WANG  
p.112



FRINGE  
p.115

NEW



MINI AXIOM  
p.123



AXIOM  
p.127



CHOPIN  
p.131

# DECORATIVO MODERNO MODERN DECORATIVE



ASIA  
p.137

NEW



ARGO  
p.144

NEW



ARGO PLASTER  
p.148

NEW



LOTUS  
p.151

NEW



IKU  
p.155

NEW



SMOOTH  
p.158



DRAM  
p.161

NEW



SPINNAKER  
p.165

NEW



PUZZLE  
p.169



KAHLO  
p.173



BUBBLES  
p.181



PONYO  
p.185



WEDGE  
p.189

NEW



DAISHO  
p.193

NEW



ENSO  
p.199

NEW



SUNSET  
p.203

NEW



BALA  
p.206

NEW



BEN  
p.208

# DECORATIVO MODERNO MODERN DECORATIVE

NEW



ARDBEG  
p.211

NEW



OBAN  
p.217

NEW



TALISKER  
p.223

NEW



GIOIA  
p.231



MEG  
p.237

NEW



RIFLESSI  
p.243

NEW



CALLA  
p.247

NEW



CURL  
p.251

NEW



SHELL  
p.255



CARRIE  
p.261



DRAW  
p.264

NEW



BELL  
p.267

NEW



ZIG ZAG  
p.270



SANCHO  
p.273

NEW



TURATI  
p.277



OFU  
p.281



ERIN  
p.284



PICOLIT  
p.286

DECORATIVO MODERNO MODERN DECORATIVE



ISAKO  
p.288



IPANEMA  
p.289



PEGGY  
p.290



AUDREY  
p.292

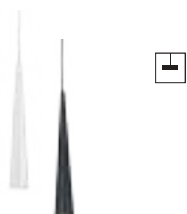

CORVINA  
p.295

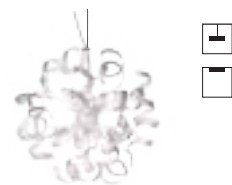

PARAISO  
p.298



FLY  
p.301



NEW  
BESANA  
p.307



EMILY  
p.311



MARILYN  
p.319



KATHY  
p.323



RUNAK  
p.326



TASHA  
p.328



CLAIRE  
p.331



GRETA  
p.337



GLENN  
p.341



HOLLY  
p.345



GLORIA  
p.349

# DECORATIVO MODERNO MODERN DECORATIVE



JUDY  
p.354



GRACE  
p.356



SOPHIA  
p.361



MILETO  
p.364



ALDRIN  
p.366



COLLINS  
p.368



FARIS  
p.371



KOFI  
p.374



RENOIR  
p.377



JULIA  
p.380



CAMBRIA  
p.383



MINX  
p.387



BONNY  
p.390



LEILA  
p.393



AISHA  
p.399

NEW



UMA  
p.403

NEW



SALLY  
p.406



HOLDEN  
p.408

DECORATIVO MODERNO MODERN DECORATIVE



BEK  
p.410



SNAP  
p.411



VIVIEN  
p.413



BYRON  
p.417



NERELLO  
p.420



LINA  
p.422



NEW



TASCA  
p.424



NEW



VITTORI  
p.427



POLO  
p.430



TOOL  
p.431



ELMER  
p.432



DUFFY  
p.434



RAVEL  
p.436



DRILL  
p.438



HARPER  
p.440



DARRYL  
p.443



TESLA  
p.446



KLAUS  
p.449



DECORATIVO MODERNO MODERN DECORATIVE



NELSON  
p.452



KEATS  
p.453



OPTIMA  
p.454



FREDDY  
p.455



EDITH  
p.457



MOODY  
p.460



MELBA  
p.462



ARIAL  
p.464



MYRIAD  
p.466



SAND  
p.468



AUSTIN  
p.470



DAVID  
p.472



DRIVE  
p.474



GRIP  
p.478



GEORGIA  
p.480



BENOIT  
p.482



BARNEY  
p.484



TOM  
p.486



DECORATIVO MODERNO MODERN DECORATIVE



ELLIS  
p.487



PLAYA  
p.489



WESS  
p.493



ASTRID  
p.497



BINNIE  
p.501



FOLKS  
p.506



BALZAC  
p.508



LIND  
p.510



MORI  
p.513



TITO  
p.516



ALLEN  
p.518



ACABA  
p.520



DONNA  
p.522



NEW



POM  
p.524



PERLA  
p.527



SIPLE  
p.530



BRENDA  
p.532



SID  
p.534

# DECORATIVO MODERNO MODERN DECORATIVE



SCRAT  
p.537



GOGOL  
p.540



ROMAN  
p.542



JENNY  
p.543



PARK  
p.544



MAGDA  
p.546



YUCCA  
p.548



MAGÒ  
p.549



JOHN  
p.550



CALEB  
p.551



SCILLA  
p.552



AMELIE  
p.554



ALBATROS  
p.555



BOND  
p.556



KAWA  
p.558



CURTIS  
p.560



CHANDRA  
p.562



HOLE  
p.564

DECORATIVO MODERNO MODERN DECORATIVE



ACE  
p.565



KALERI  
p.567



INGRID  
p.570



MILLA  
p.573



SYRAH  
p.576



BALOS  
p.578



MELVIN  
p.580



MELARA  
p.582



SODDY  
p.584



PIAF  
p.586

# DECORATIVO CLASSICO CLASSIC DECORATIVE

NEW



LA SCALA  
p.591



MACBETH  
p.596



CAROLINE  
p.598



AMARAL  
p.601



JESSICA  
p.606



ROYAL  
p.608



BOLSHOI  
p.611



VIOLINA  
p.615



LYNETTE  
p.618



CONTRACT SWAROVSKI  
p.620



AMANDA  
p.623



FLORAL  
p.626



METROPOLITAN  
p.629



MEREDITH  
p.632



REGIO  
p.635



SALOMÈ  
p.638



FELICE  
p.640



LUKE  
p.643



# DECORATIVO CLASSICO CLASSIC DECORATIVE



KAREN  
p.649



CILEA  
p.655



FENICE  
p.658



GIGLIO  
p.660



FRANCIS  
p.661



LIBBY  
p.662



ANNETTE  
p.664



WENDY  
p.665



ALICE  
p.666



JARVIS  
p.667



SERENA  
p.668



NICKY  
p.670



CANDICE  
p.672



FELIX  
p.673

## LAMPADE DA ESTERNO OUTDOOR

NEW



PIC-NIC  
p.677

NEW



SIESTA  
p.681

NEW



TAKE AWAY  
p.687

NEW



TAKE AWAY SOUND  
p.691



WALT  
p.694

NEW



BIANCA  
p.696

## LAMPADE DA BAGNO BATHROOM LIGHT



READ  
p.700

NEW



SAYA  
p.702



TAYLOR  
p.704



NEMO  
p.705



ABIKA  
p.706



DYLAN  
p.707



ELONIA  
p.708



PIPER  
p.709



ALTEA  
p.710

## LAMPADE DA BAGNO BATHROOM LIGHT



BLUMEA  
p.711



ZED  
p.712

## VENTILATORI PADDLE FAN

NEW



GRECALE  
p.716

NEW



MELTEMI  
p.717



ELENA  
p.718



TRICIA  
p.720







DECORATIVO  
MODERNO  
MODERN  
DECORATIVE





# iGLOO

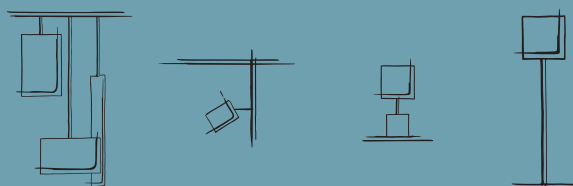

" i " per la componente tecnologica che lo caratterizza, la doppia "o" per la forma tondeggiante, iGloo è un apparecchio LED (2700K) a sospensione, da parete, da tavolo e da terra. Dotato di attacco magnetico per il posizionamento del corpo illuminante che consente di orientare di 360° il fascio luminoso netto e definito, il prodotto è caratterizzato da una tripla accensione: luce diretta diffusa (dimmerabile), luce di cortesia e luce di cortesia e diffusa insieme. Disponibile in finitura total white o nera con dettaglio oro lucido.

" i " because of the technological component that marks out the luminaire, the double "o" for the rounded shape, iGloo is a LED luminaire (2700K) available as suspension, wall, table and floor lamp. Equipped with a magnetic joint for tilting by 360° the luminaire with a sharp and defined lighting beam, the product is equipped with three different lighting switching: diffused direct light (dimmerable), courtesy light and courtesy and wide emission together. Available in total white or black finish with polished gold detail.





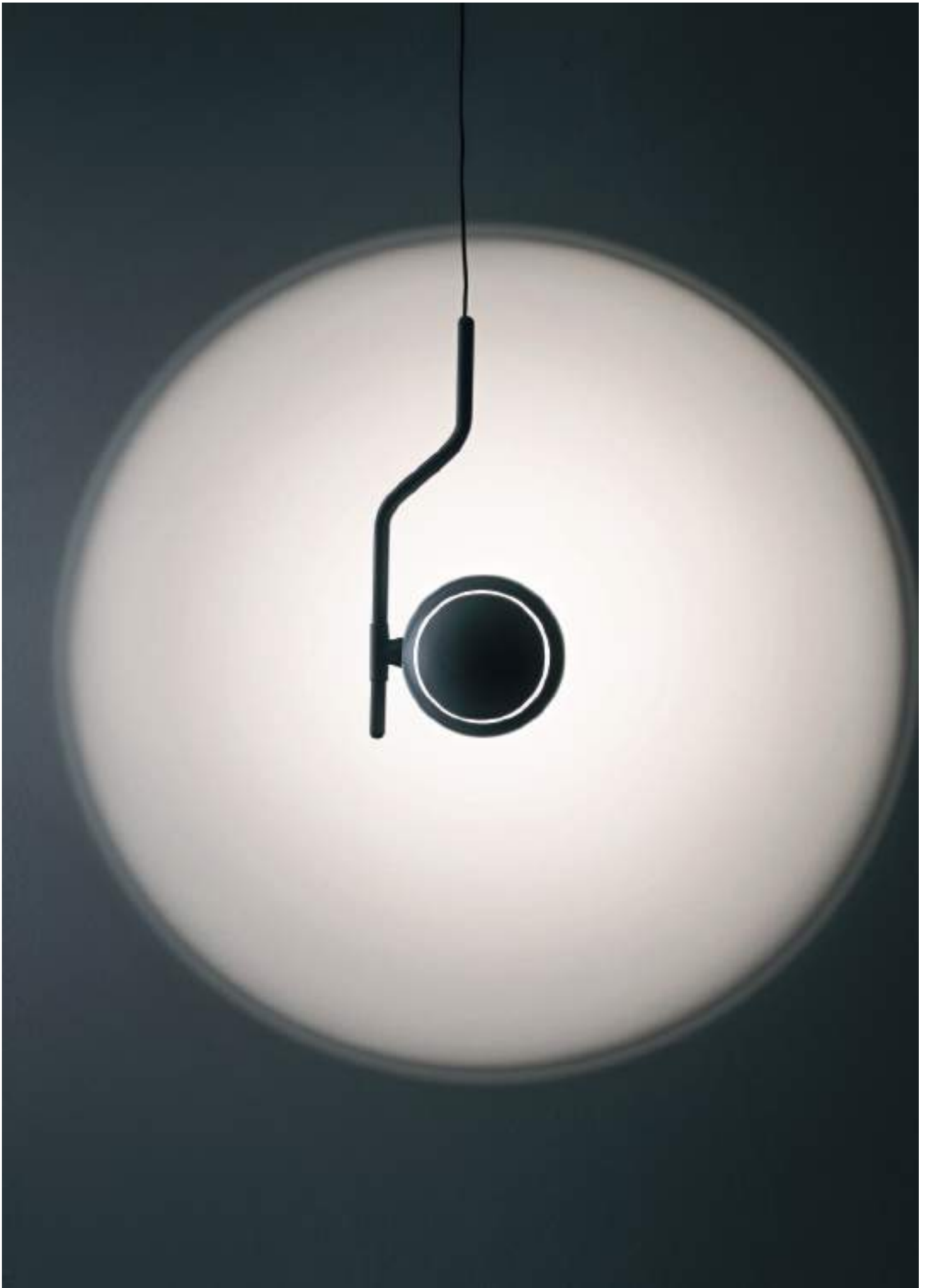

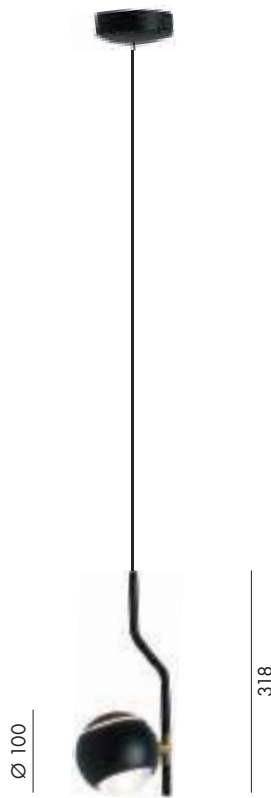

**IGL001**

LED 5W+3,5W

2700K 450+50 lm

cavo cable L.max 2000mm

rosone ceiling rose Ø90x30mm

⊕ ⊖ IP20 CE

B NOL



**IGL003**

LED 5W+3,5W

2700K 450+50 lm

⊕ ⊖ IP20 CE

B NOL

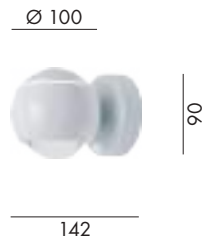

**IGL002**

LED 5W+3,5W

2700K 450+50 lm

⊕ ⊖ IP20 CE

B NOL

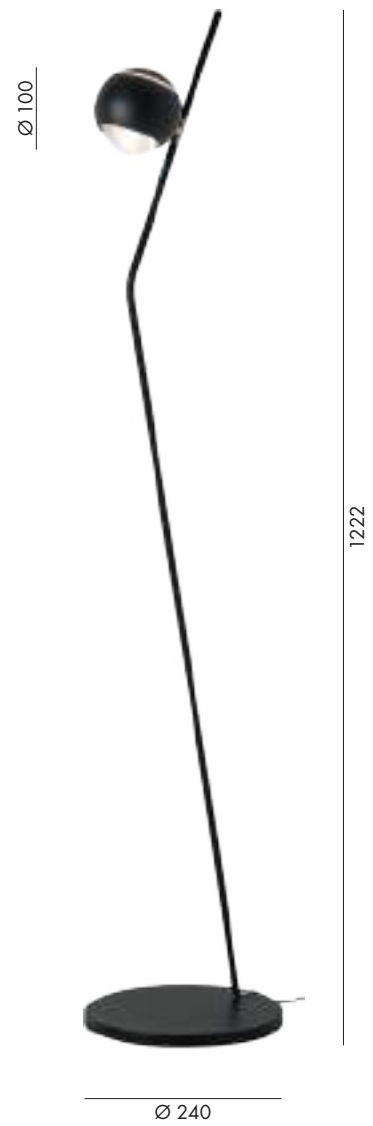

**IGL004**

LED 5W+3,5W

2700K 450+50 lm

⊕ ⊖ IP20 CE

B NOL









design by Chiaromonte Marin



# TERRAZZA MARTINI

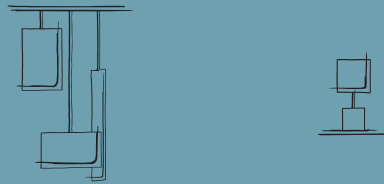

Quale migliore drink di un buon Martini, con annegata nella coppa da cocktail una gustosa oliva? Dalla forma tondeggiante dell'oliva nasce il design di questa lampada, ideata dai designers Chiaramonte e Marin. Composta da un diffusore tondo in vetro soffiato a mano in finitura fumè, con un'anima LED al suo interno, realizzata da un cilindro in vetro bianco opaco che diffonde la luce delle schede LED. Proposta in versione da tavolo e a sospensione, con dettagli di chiusura realizzati in ottone satinato.

What better cocktail than a Martini with a tasty olive plunged into the cocktail glass? The plump olive inspired the shape of this luminaire, created by the designers Chiaramonte and Marin. Made of a smoked finish hand-blown glass round diffuser with an internal LED soul in a milky white sandblasted glass cylinder. The internal diffuser encloses the LED boards fixed into an aluminium structure. Available as table and suspension lamp, with closing details in brass satin finish.



Ø 350

**TEROO1**

LED 20W

2700K 2340 lm

cavo cable L.max 1500mm

rosone ceiling rose Ø160x45mm



⊕ ⊖ IP20 CE



**TER002**

LED 20W

2700K 2340 lm



⊕ ⊖ IP20 CE Ⓢ

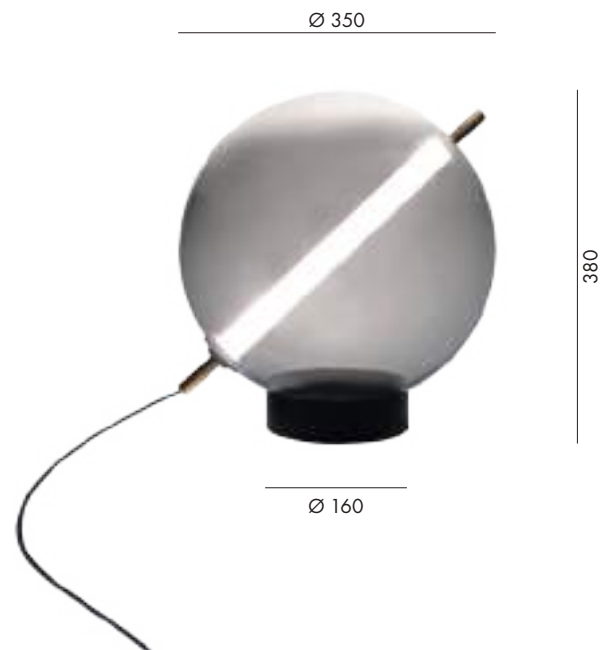



# CRYSTAL

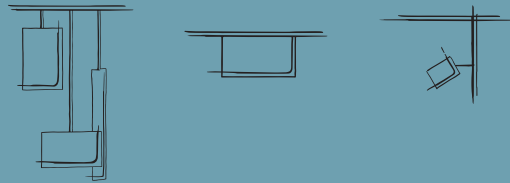

Leggera e trasparente, Crystal è una lampada LED a sospensione, parete e soffitto dalla forma squadrata, con corpo centrale in alluminio e diffusore in PMMA micro-inciso a laser per un illuminamento omogeneo diretto e indiretto. Disponibile in versione 2700K, in diverse misure e relative potenze e in due finiture colore, bianco e oro satinato.

Light and transparent, Crystal is a LED suspension, wall and ceiling lamp with a square shape, with a central aluminium structure and a micro-laser engraved PMMA diffuser for a direct and indirect homogeneous lighting emission. Available in 2700K, in different sizes and related powers, and in two colour finishes, white and satin gold.



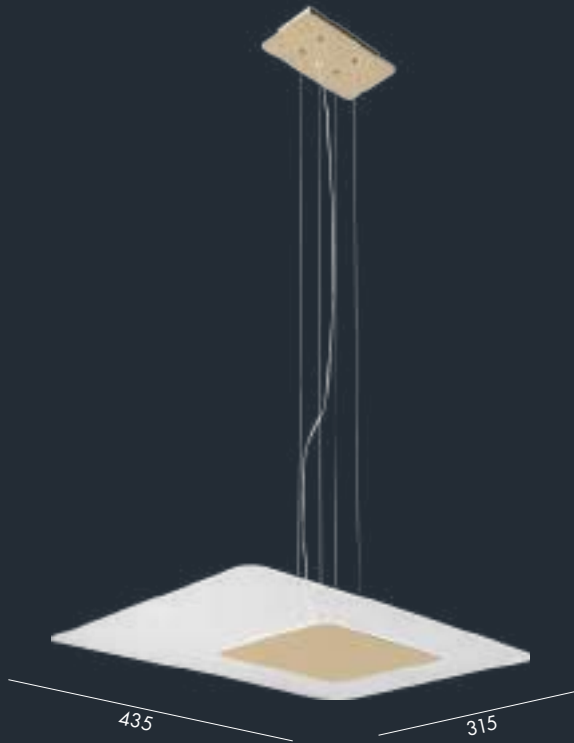

**CRY003**

LED 24W  
2700K 2500 lm

cavo cable L.max 1500mm  
rosone ceiling rose 235 x 140 x 40mm

⊕ ⊖ IP20 CE

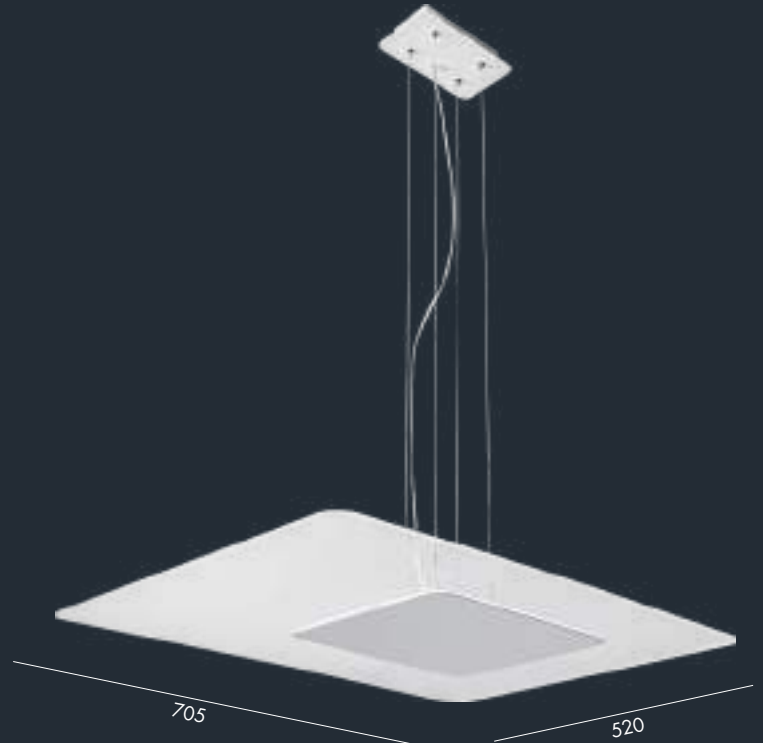

**CRY004**

LED 40W  
2700K 4300 lm

cavo cable L.max 1500mm  
rosone ceiling rose 240 x 150 x 40mm

⊕ ⊖ IP20 CE



**CRY001**

LED 17W  
2700K 1800 lm

⊕ ⊖ IP20 CE



**CRY002**

LED 24W  
2700K 2500 lm

⊕ ⊖ IP20 CE



compatibile con tecnologia smart (contatta il nostro ufficio commerciale)  
suitable for smart LED (contact our sales office)





Personalizzabile nella colorazione della struttura in alluminio.  
Colour of the aluminium body available upon request.



N T GR MA ORO ARG RA





design by Stefano Valente



# REMO

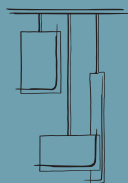

Apparecchio illuminante a LED (2700K) a sospensione dalla particolare forma asimmetrica che ricorda quella di un remo. Disegnata e ideata da Stefano Valente è composta da un corpo in alluminio spesso solo 4mm, è estremamente versatile e ha uno stile tecnico-decorativo. Disponibile nella versione monoemissione o biemissione. Nella versione monoemissione a luce indiretta il corpo è un volume pieno e liscio anche nella parte inferiore. Nelle versioni monoemissione a luce diretta e biemissione l'apparecchio presenta un taglio di soli 20mm di larghezza nella parte inferiore su cui poggia uno schermo diffusore in policarbonato opale a protezione del LED. Disponibile in finitura bianca e ottanio.

LED pendant lamp (2700K) with a particular asymmetric shape reminiscent of an oar. Aluminium body, only 4mm thick. Designed and created by Stefano Valente, it is extremely versatile and has both a technical and a decorative style. Available as indirect, direct or direct/indirect light emission. In the indirect light version, the body is a full and smooth volume; in the direct and direct/indirect versions the structure has a cut, only 20mm wide, in the lower part where an opal polycarbonate diffuser protects the LED. Available in white and teal finishes.



MONOEMISSIONE LUCE DIRETTA DIRECT LIGHT

**REM001**



LED 66W

2700K 6250 lm

cavo cable L.max 1500mm

rosone ceiling rose 40x40x30mm

⊕ ⊖ IP40 CE



MONOEMISSIONE LUCE INDIRETTA INDIRECT LIGHT

**REM002**



LED 53W

2700K 5000 lm

cavo cable L.max 1500mm

rosone ceiling rose 40x40x30mm

⊕ ⊖ IP40 CE

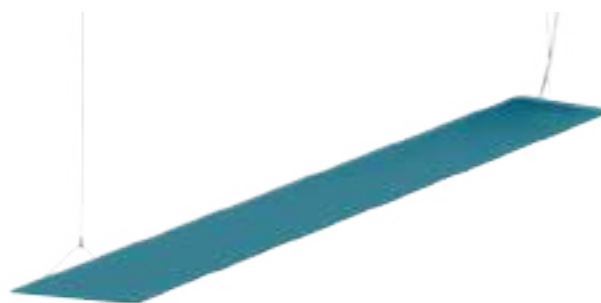

BIEMISSIONE DIRECT-INDIRECT LIGHT

**REM003**



LED 66W+26W

2700K 6250 + 2500 lm

cavo cable L.max 1500mm

rosone ceiling rose 40x40x30mm

⊕ ⊖ IP40 CE



# Pemo

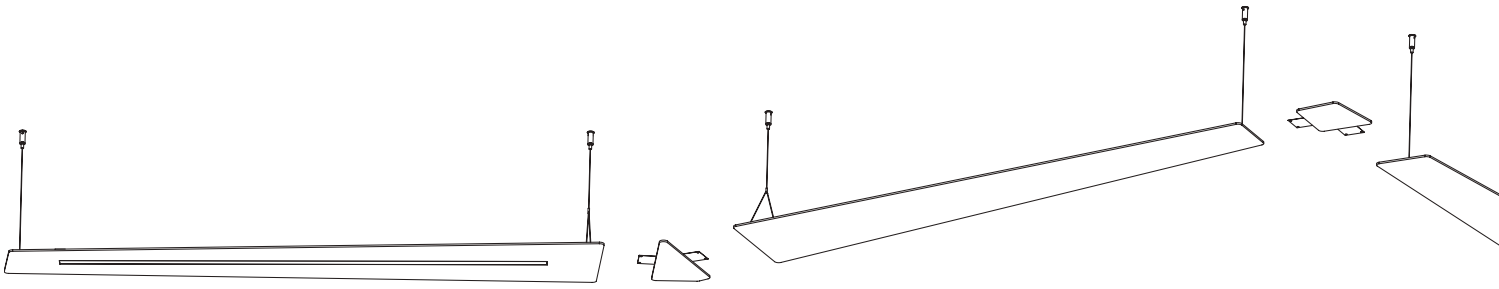
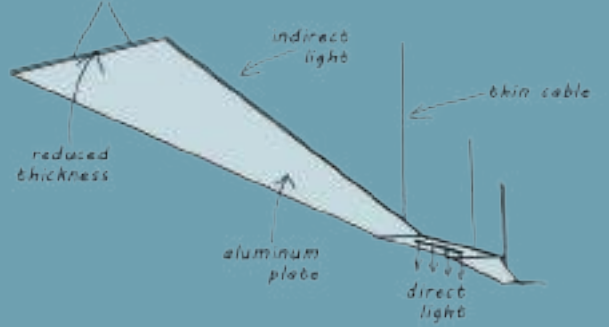



Personalizzabile nella temperatura colore del LED e nella composizione con giunti lineari e angolari per composizioni a sistema.  
Available upon request: different LED colour temperature and linear and angle joints for in-line installations.

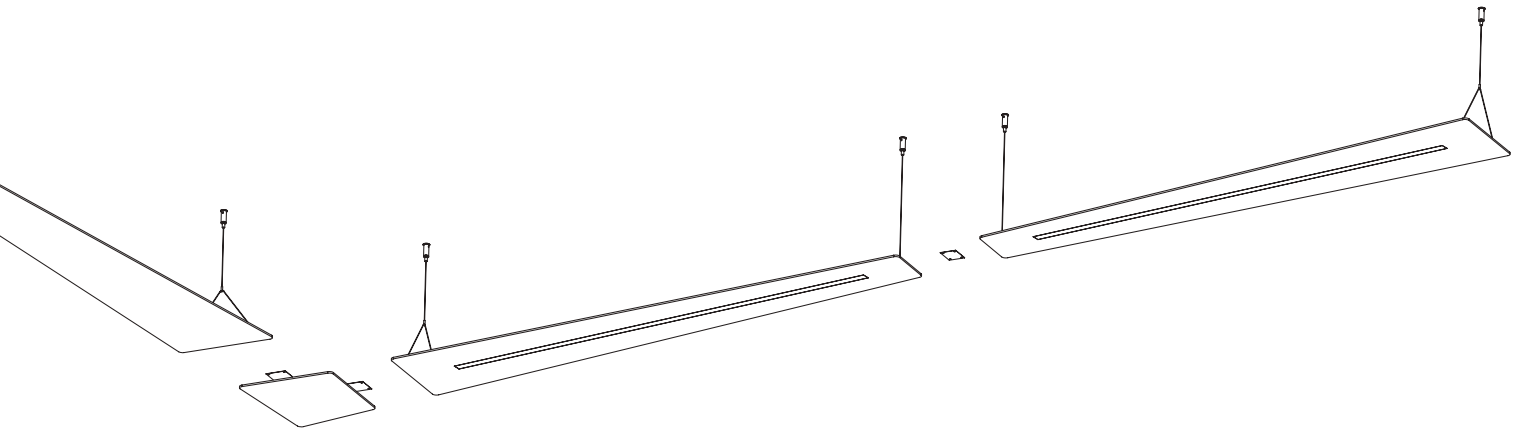

new

design by Andrea Lazzari



# PAVÈ

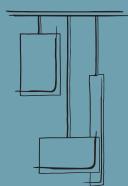

A Milano il pavè riveste le strade del centro. I ciottoli in porfido vengono accostati e le fughe sigillate con sabbia e cemento. Il cemento, quest'ultimo materiale, diventa protagonista assoluto di questa lampada ideata da Andrea Lazzari, nel volume pieno e materico del diffusore dalla forma essenziale e pulita. Lampada a sospensione con attacco GU10, per un'ottima luce d'accento e concentrata sopra un tavolo da pranzo. In cemento in finitura grigia, con cavo di sospensione in PVC trasparente.

In Milan pavè covers the downtown streets. The cobblestones are in close proximity to each other with the gaps sealed with a sand concrete mixture. Concrete is the key driving factor in the creation of this lamp (design by Andrea Lazzari) and gives full volume material look to the diffuser, with its essential and clean shape. Pendant lamp with GU10 lamp holder, for an excellent accent lighting above a dining table. In grey finish concrete, with transparent PVC suspension cable.

MADE IN  
MILANO



**PAV001**

GU10 1x40W max  
cavo cable L.max 1200mm  
rosone ceiling rose Ø 100x30mm



⊕ ⊖ IP20 CE





# TWIN

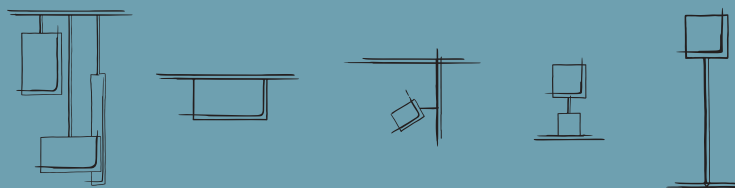

Apparecchio illuminante altamente decorativo, Twin si compone di una struttura in metallo su cui poggiano i portalampada. Proposta in due abbinamenti: con finitura tutta ottone satinato o nella versione con struttura verniciata nera e portalampada in ottone satinato. Disponibile nella versione a sospensione, da soffitto, da parete, da tavolo e da terra con attacco E27 con lampadina a vista che consente all'utente di montare una lampadina a sua scelta, personalizzando ulteriormente il prodotto.

Highly decorative luminaire, Twin consists of a metal structure with the lamp holders. Available in two combinations: completely satin brass or with black painted structure and satin brass lamp holders. Available as E27 suspension, ceiling, wall, table and floor lamp, with visible lamp, that allows the user to mount a light bulb of his choice and further personalize the product.





**TWI001**

E27 2x42W max  
 cavo cable L.max 1300mm  
 rosone ceiling rose 320x50x30mm

⊕ ⊖ IP20 CE



**TWI003**

E27 1x42W max

⊕ ⊖ IP20 CE

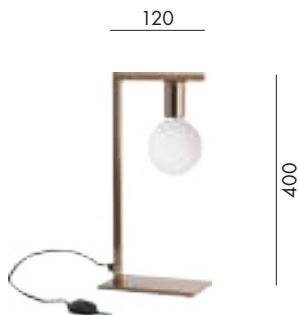

**TWI004**

E27 1x42W max  
 base base 190x120x80mm

⊕ ⊖ IP20 CE



**TWI002**

E27 2x42W max  
 rosone ceiling rose 110x110x25mm

⊕ ⊖ IP20 CE

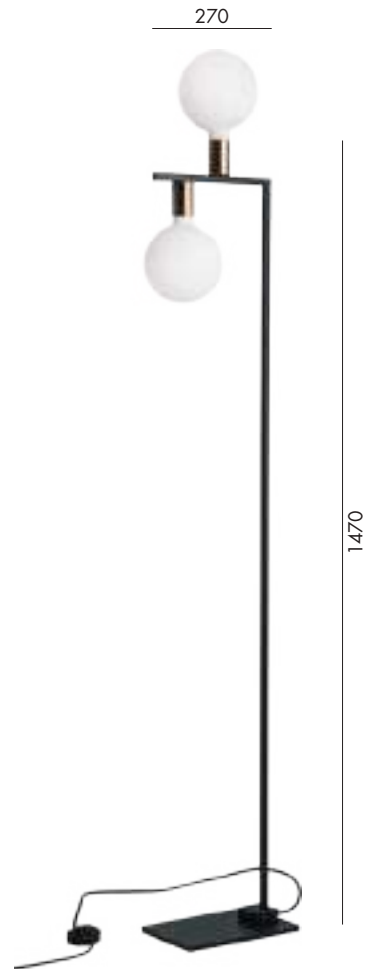

**TWI005**

E27 2x42W max  
 base base 270x180x10mm

⊕ ⊖ IP20 CE













Personalizzabile nella colorazione della struttura e portalampada in metallo.  
Colour of the metal body and lamp holder available upon request.



design by Jurre Groenenboom



# KARAOKE

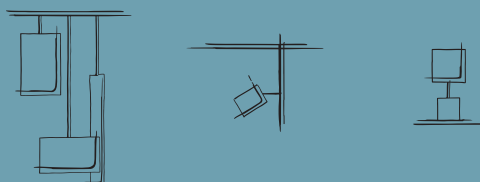

Prende spunto dalla forma del microfono e si chiama Karaoke. Lampada a sospensione, da parete e da tavolo composta da un portalampada E27 in ottone spazzolato pieno, il cui effetto materico è impreziosito dal contrasto con la struttura in metallo nero opaco. Un prodotto che si presta alla personalizzazione grazie all'utilizzo di lampade decorative LED: in particolare la finitura fumè delle nostre lampadine vintage ne risalta particolarmente i contrasti cromatici. Versione a sospensione proposta anche in caduta multipla con kit decentramento a tre e cinque elementi.

Inspired by the shape of the microphone, it's called Karaoke. Pendant, wall and table lamp with E27 lamp holder in brushed solid brass, whose material effect is enhanced by the contrast with the matt black metal structure. It allows customization thanks to the use of decorative LED lamps, in particular our vintage light bulbs in smoked finish bring out particularly the colour contrasts. Pendant version available in multiple composition, with decentralization kit for three or five elements.





### KAR001NOTS

E27 1x42W max  
 cavo cable L.max 2000mm  
 rosone ceiling rose Ø80x30mm

⊕ ⊖ IP20 CE



225

### KAR002NOTS

E27 1x42W max  
 attacco a parete wall support Ø100x25mm

⊕ ⊖ IP20 CE



Ø 170

410

### KAR003NOTS

E27 1x42W max

⊕ ⊖ IP20 CE









#### KAR004NOTS

E27 3x42W max

cavo cable L.max 2000mm

rosone ceiling rose Ø 120x25 mm



⊕ ⊖ IP20 CE



#### KAR005NOTS

E27 5x42W max

cavo cable L.max 2000mm

rosone ceiling rose Ø 120x25 mm



⊕ ⊖ IP20 CE







# TSUKI

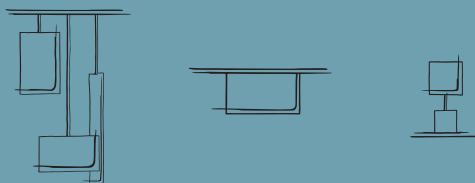

Lampada a sospensione, a soffitto e da tavolo con attacco E27, che consente di montare lampadina a LED. Struttura dalla forma semi-circolare in metallo verniciato nero, su cui si appoggia un piattello color oro lucido agganciato al diffusore, una sfera in vetro satinato bianco opaco, che consente un'ottima diffusione della luce. Cavo in pvc nero, rosone in metallo nero. Prodotto semplice, ma dal gusto decorativo, adatto in ambienti di diversi stili dove ricrea un romantico effetto simile ad una luna.

Pendant, ceiling and table lamp with E27 lamp holder that allows mounting LED lamp. Semi-circular structure in black painted metal, with a shiny gold plate placed on it and connected to the diffuser, a satin white glass sphere, which allows diffused light emission. Black pvc cable, black metal ceiling rose. Simple but with a decorative taste, this lamp is suitable in environments of different styles where it recreates a romantic effect similar to a moon.



**TSU001NOL**

E27 1x40W max

cavo cable L.max 2000mm

rosone ceiling rose Ø75 x 20mm



⊕ ⊖ IP20 CE



**TSU002NOL**

E27 1x40W max

⊕ ⊖ IP20 CE



**TSU003NOL**

E27 1x40W max

⊕ ⊖ IP20 CE







# EMPTY

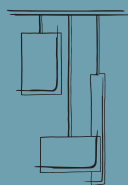

Lampada a sospensione dal design minimale, composta da una struttura vuota dalla forma trapezoidale in metallo verniciato, disponibile nelle finiture bianco, giallo e nero. Cavo in PVC in tinta per le versioni nera e bianca, cavo nero sulla versione gialla; rosone in tinta con il corpo lampada. La vera protagonista in questo apparecchio è la lampadina: cablato con attacco E27, con lampadina a vista, il prodotto si personalizza ulteriormente, consentendo all'utente di montare una lampadina a sua scelta. Perfetta per abitazioni moderne e minimal, si presta all'installazione in una cucina, un ambiente living ma anche in una cameretta.

Pendant lamp with a minimal design, composed by an empty structure with a trapezoidal shape in painted metal, available in white, yellow and black colours. PVC cable matching to the black and white versions, black on the yellow version; ceiling rose in the same colour of the body. The real protagonist in this luminaire is the light source, an E27 lamp holder with visible lamp, that allows the user to mount a light bulb of his choice and further personalize the product. Perfect for modern and minimal homes, for installation in the kitchen, the living area but also in the kids bedroom.



MADE IN  
MILANO



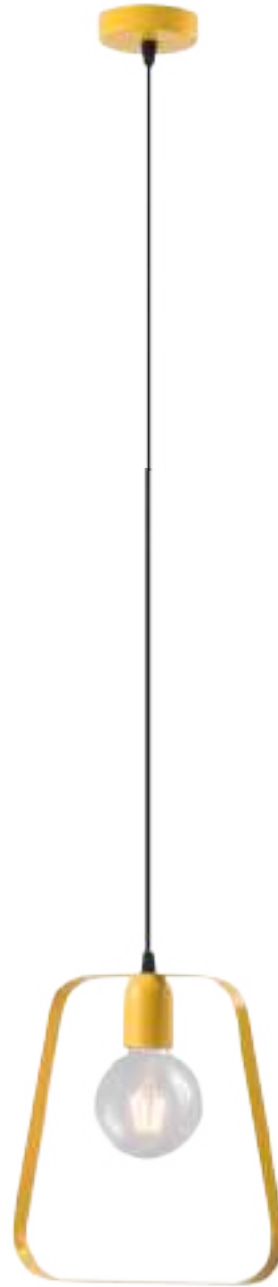
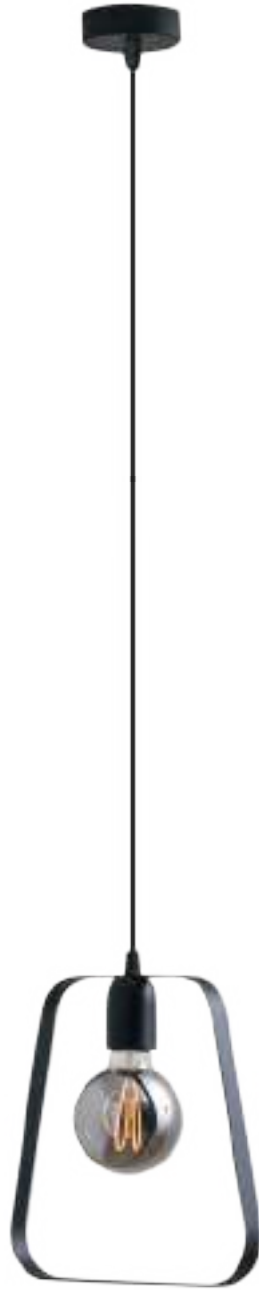

260

250

### EMPO01

E27 1x75W max

cavo cable L.max 2000mm

rosone ceiling rose Ø85x25mm



⊕ ⚡ IP20 CE

B

N

G



# JAY



Lampada a sospensione e soffitto con struttura dalla forma circolare minimale in metallo, disponibile in finitura cromata, bianca e nera. Rosone in tinta con la struttura, cavo di sospensione trasparente per la versione cromo, in tinta per le finiture bianca e nera. Attacco E27 con lampadina a vista, che consente all'utente di montare una lampadina a sua scelta, personalizzando ulteriormente il prodotto.

Pendant and ceiling luminaire with metal round structure available in chrome, white or black finish. Ceiling rose in the same colour of the body, clear suspension cable for the chrome version, black and white for the coloured finishes. E27 lamp holder with visible lamp, that allows the user to mount a light bulb of his choice and further personalize the product.



MADE IN  
MILANO



### JAY001

E27 1x75W max

cavo cable L.max 2000mm

rosone ceiling rose Ø100x25mm



⊕ ⊖ IP20 CE

CR

B

N

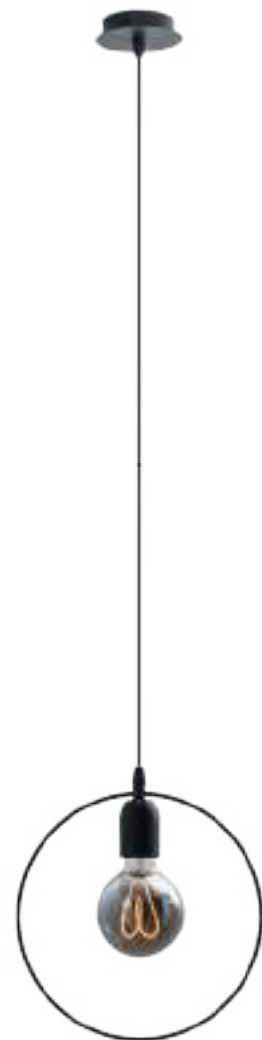
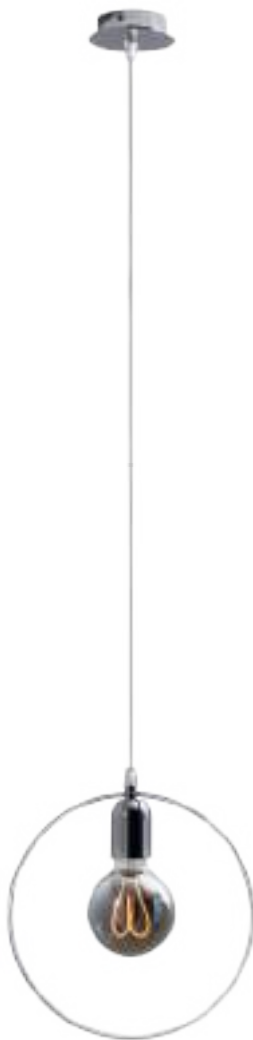

Ø 280

### JAY002

E27 1x75W max

rosone ceiling rose Ø100x25mm



⊕ ⊖ IP20 CE

CR

B

N



Ø 280





# ORBIT

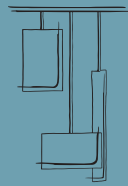

Lampada LED a sospensione (2700K) dalla sottile forma circolare. Struttura in alluminio estruso curvato, diffusore in policarbonato opale. Cavo di alimentazione in PVC trasparente. Proposta in tre diametri e relative potenze, in finitura bianca o nera. Da completare con rosoni, sia per montaggio singolo che per composizioni multiple (a due o tre elementi), che possono essere configurate dall'utente, personalizzando ulteriormente il prodotto con composizioni scenografiche e di grande impatto. Ideale per hall, zone living e grandi spazi.

LED pendant lamp (2700K) with a thin and minimal round shape. Extruded aluminium body with opal polycarbonate diffuser. PVC transparent power cable. Available in three sizes and related powers, in black or white finishes. The body has to be completed with ceiling rose, both in single version and in multiple compositions (with two or three elements) that can be set up by the client and further personalize the product in scenographic and big compositions. Ideal for halls, living areas and big spaces.

CORPO DIFFONDENTE / DIFFUSER

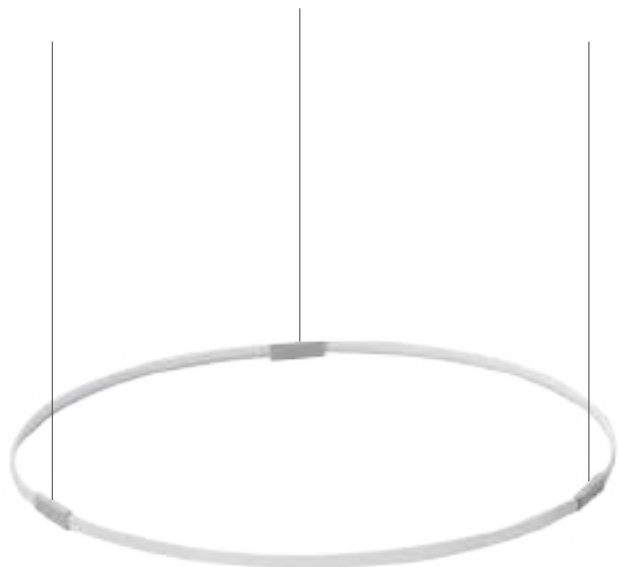

**ORB001**

LED 38W - Ø 600 mm  
2700K 2850 lm



⊕ ⊖ IP20 CE



**ORB002**

LED 50W - Ø 800 mm  
2700K 3750 lm



⊕ ⊖ IP20 CE



**ORB003**

LED 60W - Ø 1000 mm  
2700K 4500 lm



⊕ ⊖ IP20 CE



ROSONI / CEILING ROSES

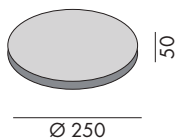

**MT.ORB101**

Rosone singolo max 60W  
Single ceiling rose max 60W

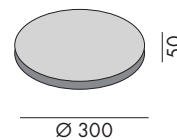

**MT.ORB102**

Rosone per composizione max 200W  
Composition ceiling rose max 200W



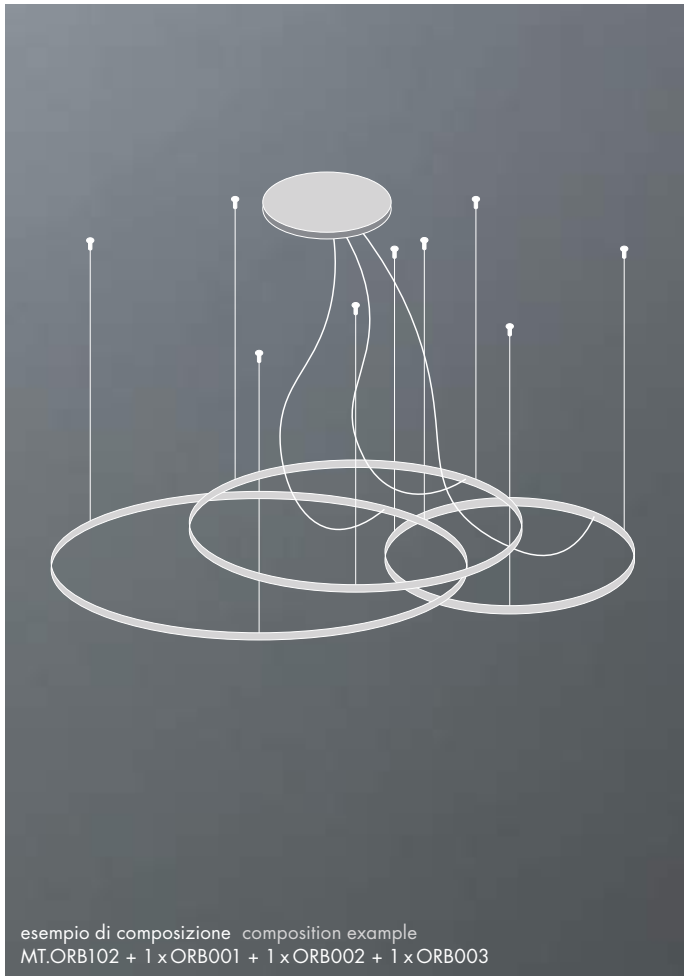
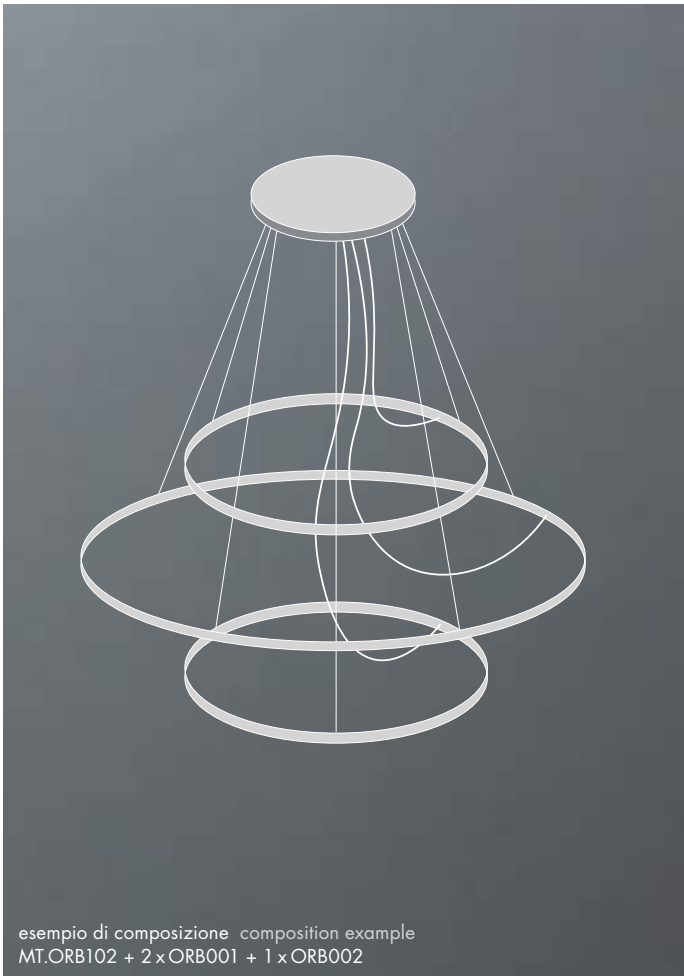
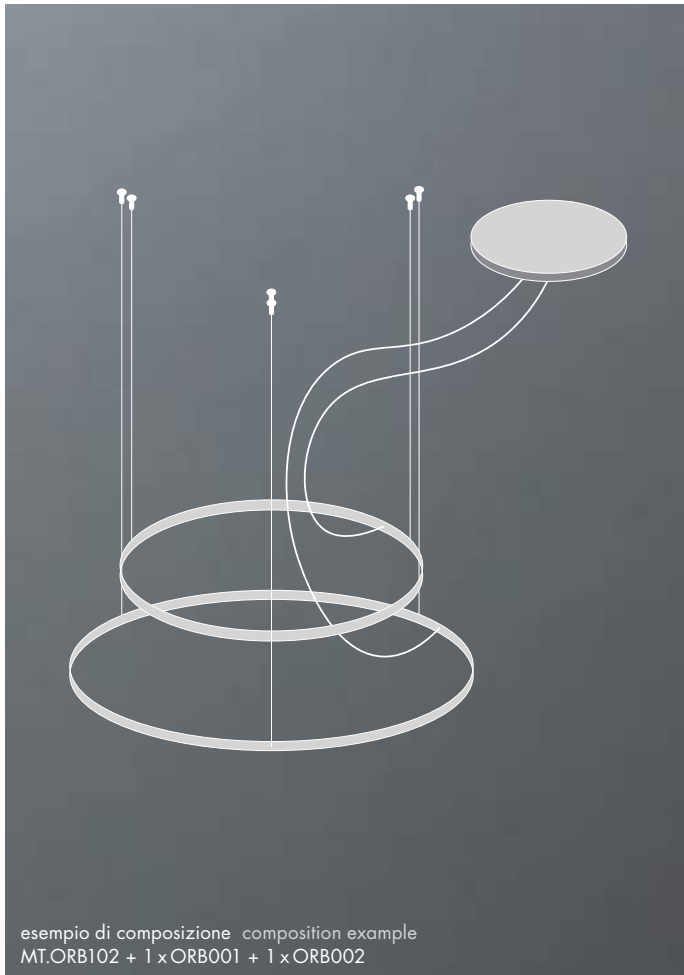
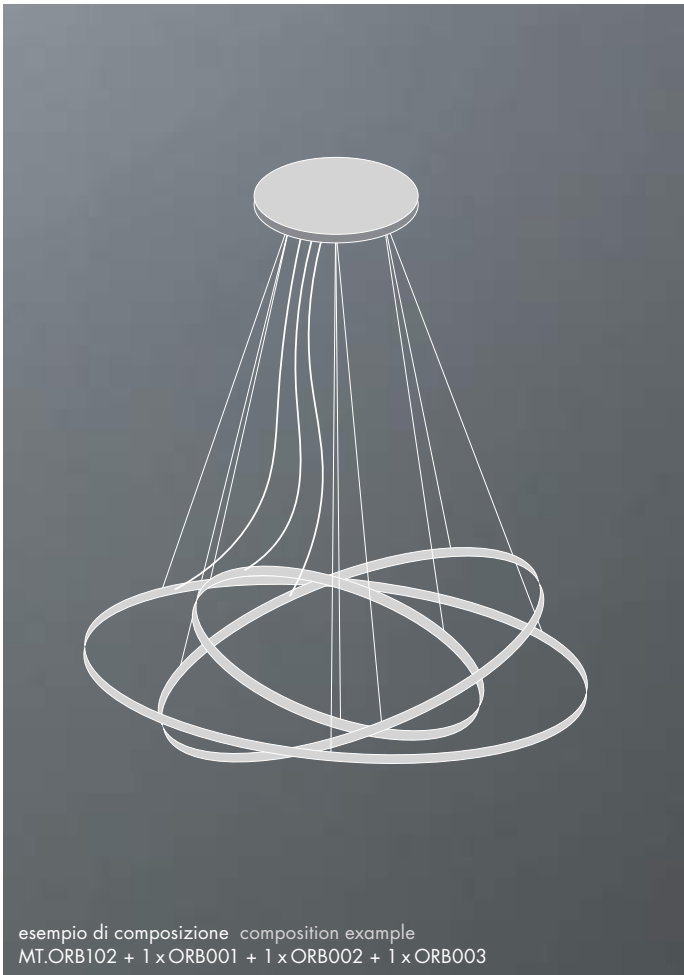







# ERKEL

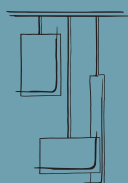

Lampada a sospensione da 1, 3, 5 luci dal design minimale, composta da portalampada in alluminio e rosone in tinta, proposti nei colori bianco, nero, cromo, bronzo e rame lucido. Fornita con cavo elettrificato in tessuto proposto nei colori bianco, nero, rosso e bronzo in associazione al colore del portalampada. Attacco E27 con lampadina a vista, che consente all'utente di montare una lampadina a sua scelta, personalizzando ulteriormente il prodotto.

Pendant lamp with 1, 3 or 5 light points. Minimal design, consisting of an aluminium lamp holder and ceiling rose in the same colour (available in white, black, chrome, bronze and gloss copper finish). Supplied with fabric electrical cable available in white, black, red and bronze finish according to the colour of the body. E27 lamp holder with visible lamp, that allows the user to mount a light bulb of his choice and further personalize the product.







**ERK101**



E27 1x75W max

cavo cable L.max 3000mm

rosone ceiling rose Ø120x25mm

⊕ ▽ IP20 CE

B

N

CR

BZ

RA





### ERK103

E27 3x75W max  
cavo cable L.max 3000mm  
rosone ceiling rose Ø 120x25mm



⊕ ⚡ IP20 CE B N CR BZ RA



### ERK105

E27 5x75W max  
cavo cable L.max 3000mm  
rosone ceiling rose Ø 120x25m



⊕ ⚡ IP20 CE B N CR BZ RA



# LEIKA

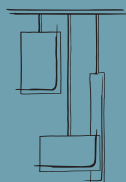

Lampada a sospensione singola con portalampada in silicone e cavo in tessuto, in tinta con la struttura e il rosone. Attacco E27 con lampadina a vista, che consente all'utente di montare una lampadina a sua scelta, personalizzando ulteriormente il prodotto. Proposta nelle finiture bianca, nera, grigia, rossa e gialla.

Single pendant lamp with silicone lamp holder and fabric cable, in the same colour of structure and ceiling rose. E27 lamp holder with visible lamp, that allows the user to mount a light bulb of his choice and further personalize the product. Available in five finishes (black, white, grey, red and yellow).





**LEK001**

E27 1x42W max  
 cavo cable L.max 2000mm  
 rosone ceiling rose Ø100x60mm



⊕ ⊖ IP20 CE B N GR R G



compatibile con lampadine LED con tecnologia smart (pag. 730)  
 suitable for smart LED light bulbs (pag. 730)

*lampadina LED consigliata: L.293-5/L.283-12-4/L.283-5-FU (pag. 724-726)*  
*recommended LED bulb: L.293-5/L.283-12-4/L.283-5-FU (pag. 724-726)*



# WANG

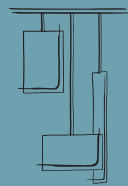

Lampada a sospensione singola con portalampada e rosone in metallo color bronzo; cavo in tessuto in tinta. Attacco E27 con lampadina a vista, che consente all'utente di montare una lampadina a sua scelta, personalizzando ulteriormente il prodotto.

Single pendant lamp with bronze metal lamp holder and ceiling rose; matching fabric cable. E27 lamp holder with visible lamp, that allows the user to mount a light bulb of his choice and further personalize the product.





**WAN001**



E27 1x75W max

cavo cable L.max 2000mm

rosone ceiling rose Ø80x30mm

□ ▽ IP20 CE



# FRINGE



Lampada da lettura orientabile a LED (3000K), installabile a parete, con pinza o da tavolo. Il braccio flessibile è rivestito da una guaina restringente nera per le varianti colore, bianca per la versione bianca, orientabile e modellabile a piacimento. Versione a parete proposta con attacco circolare su cui è posta l'accensione, o con corpo lampada orientabile e supporto rettangolare con attacco USB che consente la ricarica dei propri apparecchi. Fascio di luce concentrato che rende il prodotto adatto ad installazioni in camera da letto o nelle camere d'albergo. Disponibile in cinque finiture (bianco, nero, rosso, giallo e oro satinato).

LED reading adjustable lamp (3000K) available for wall installation, with clamp or as table version. The flexible arm is covered with a shrink sheath in black finish for the coloured versions, in white finish for the white version, adjustable to one's liking. Wall version available with circular wall support featuring the switch, or with adjustable luminaire and rectangular support with USB port that allows recharging one's devices. Narrow beam angle that makes it the perfect product for bedrooms installation, both in residential and in hotel spaces. Available in five finishes (white, black, red, yellow and satin gold).

FRINGE PARETE WALL



**FR1001**

LED 3W

3000K 180 lm

braccio bracket L.max 280mm

attacco a parete wall support Ø90x30mm



⊕ ⊖ IP20 CE B N G R OS



FRINGE PINZA CLAMP



**FR1003**

LED 3W

3000K 180 lm

braccio bracket L.max 280mm



⊕ ⊖ IP20 CE B N G R



FRINGE USB

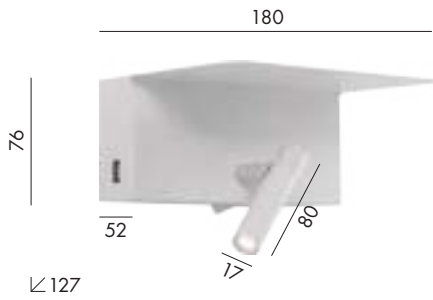

**FR1002**

LED 3W  
3000K 180 lm



⊕ ⊖ IP20 CE



FRINGE TAVOLO TABLE



**FR1004**

LED 3,5W  
3000K 180 lm  
braccio bracket L.max 360mm



⊕ ⊖ IP20 CE





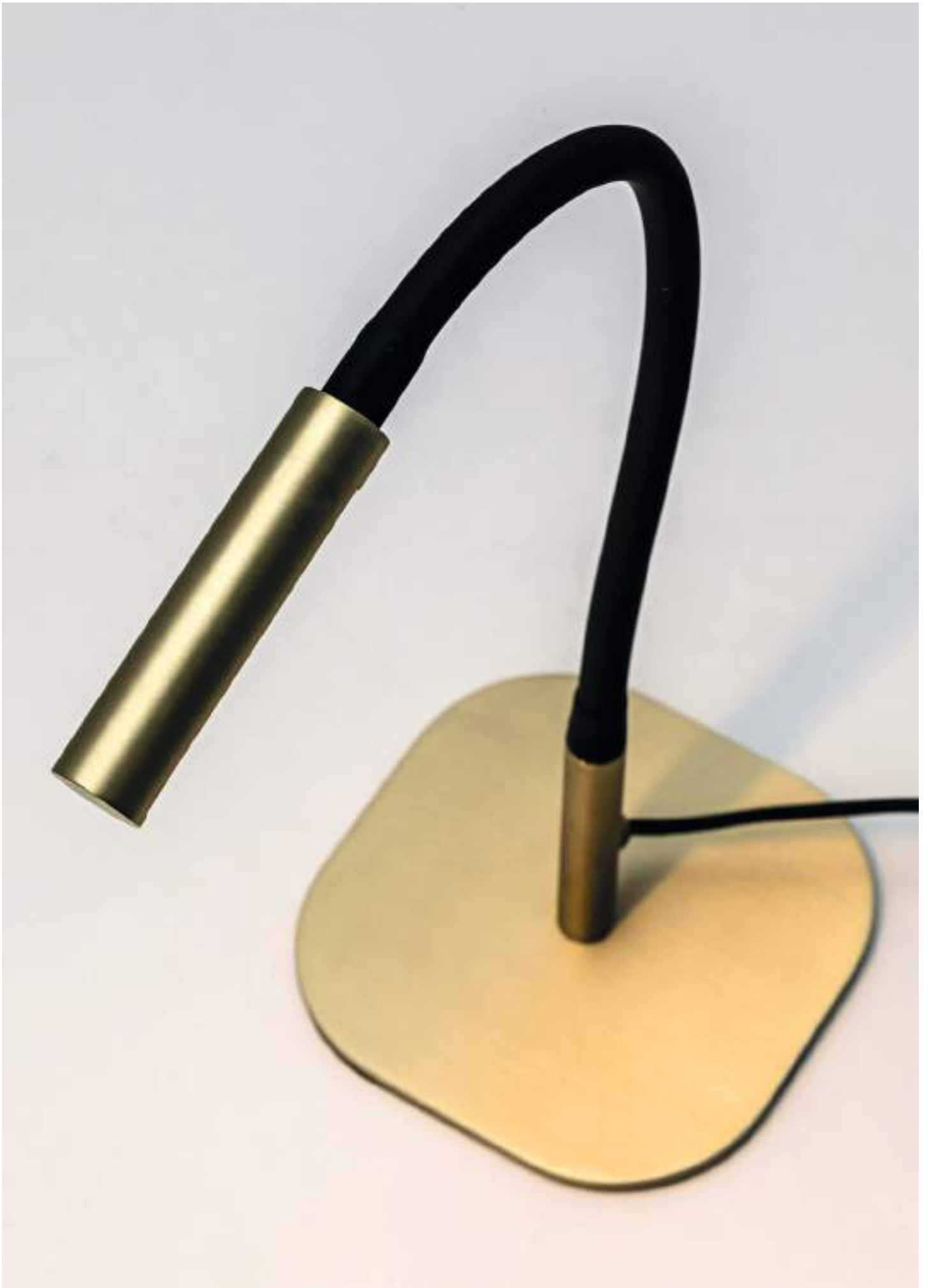









# MINI AXIOM

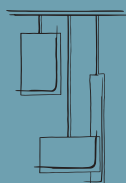

Lampada a sospensione con COB LED (3000K) con alimentatore integrato nel rosone. Struttura in pressofusione di alluminio disponibile nei colori bianco, nero e ottone bronzato. Cavo di sospensione in PVC trasparente (versione bianca), in tessuto nero (versione nera e ottone bronzato), rosone in tinta con il corpo lampada. Il riflettore dal diametro molto contenuto (soli 18mm) crea un fascio di luce molto concentrato (40°), per un'illuminazione puntuale. Ideale per qualsiasi ambiente della casa, dalla zona giorno al bagno, al corridoio, ma anche in installazioni in ambito ristorazione e hospitality. Proposto in versione singola e con rosone lineare da tre elementi in tinta con il corpo.

Pendant lamp with COB LED (3000K) with integrated driver in the ceiling rose. Die-cast aluminium body in white, black and bronze copper finishes. Suspension cable in clear PVC (white version), in black fabric (black and bronze copper versions); ceiling rose matching to the lamp body. The reflector with a very small diameter (only 18mm) creates a very concentrated light beam (40°) for accent lighting. Ideal for any room, from the living area to the bathroom and corridor, but also in restaurant and hospitality areas. Available in single version or with linear ceiling rose, in the same colour of the diffuser, for three elements.



Ø18

**AXI005**

LED 3W

3000K 200 lm

cavo cable L.max 2000mm

rosone ceiling rose Ø80x20mm



IP20 CE



**AXI008**

LED 3x3W

3000K 600 lm

cavo cable L.max 2000mm

rosone ceiling rose 700x40x40mm



IP20 CE



Personalizzabile nella colorazione della struttura in alluminio.  
Colour of the aluminium body available upon request.



ORO ARG RA



# AXIOM

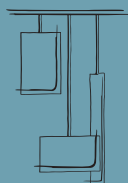

Apparecchio a sospensione a LED (3000K) con alimentatore integrato nel rosone. Struttura in pressofusione di alluminio verniciato disponibile nei colori bianco e nero. Cavo di sospensione trasparente. Riflettore in alluminio che crea un fascio di luce concentrato (40° o 50°). Disponibile in due altezze e nei diametri di 46 mm e 60 mm, nella versione singola o con rosone lineare da tre elementi in tinta con il corpo lampada.

LED pendant lamp (3000K) with integrated driver in the ceiling rose. Die-cast aluminium body available in white and black colours. Clear suspension cable. Aluminium reflector that creates a spotlight effect (40° or 50°). Available with 46 mm and 60 mm diameter, in single version or with linear ceiling rose, in the same colour of the diffuser, with three elements.



**AXI001**

LED 7W

3000K 700 lm

cavo cable L.max 1200mm

rosone ceiling rose Ø80x50mm



⊕ ⊖ IP20 CE



**AXI002**

LED 15W

3000K 1500 lm

cavo cable L.max 1200mm

rosone ceiling rose Ø80x50mm



⊕ ⊖ IP20 CE



**AXI006**

LED 3x7W

3000K 2100 lm

cavo cable L.max 1200mm

rosone ceiling rose 700x40x40mm



⊕ ⊖ IP20 CE



**AXI007**

LED 3x15W

3000K 4500 lm

cavo cable L.max 1200mm

rosone ceiling rose 700x40x40mm



⊕ ⊖ IP20 CE





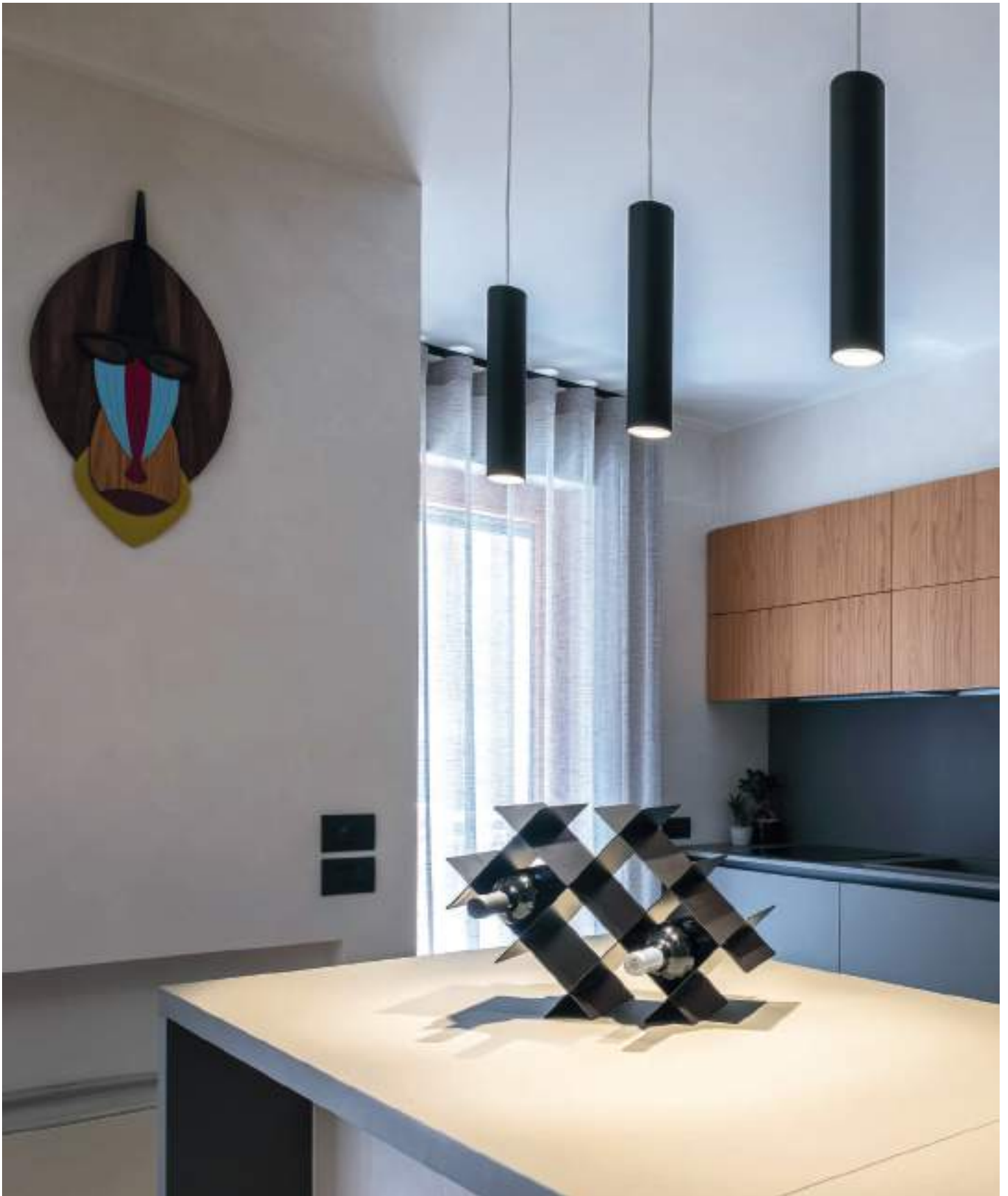

Personalizzabile nella colorazione della struttura in alluminio.  
Colour of the aluminium body available upon request.



ORO ARG RA



# CHOPIN



Lampada a sospensione e a soffitto in metallo verniciato bianco o nero con sorgente LED (3000K). Proposta in forma tonda o quadrata, la versione a sospensione è vuota al centro, nella versione a soffitto (disponibile in forma tonda o quadrata) la struttura in metallo bianca continua nella parte centrale. Diffusore in metacrilato che consente un'ottima diffusione della luce.

LED pendant and ceiling lamp (3000K) in white or black metal structure. Available in round or square shape, the pendant version is empty inside, in the ceiling version the metal white body continues in the middle. Methacrylate diffuser for optimal light diffusion.



**CHO003B**

LED 30W - Ø 450 mm  
3000K 2700 lm



**CHO005B**

LED 36W - Ø 600 mm  
3000K 3250 lm



⊕ ⊖ IP20 CE



**CHO006B**

LED 36W - L.450 mm  
3000K 2800 lm



**CHO007B**

LED 48W - L.600 mm  
3000K 3300 lm



⊕ ⊖ IP20 CE

**CHO002**

LED 30W - Ø450mm  
3000K 2700 lm



**CHO001**

LED 36W - Ø600mm  
3000K 3250 lm



cavo cable L.max 1200mm  
rosone ceiling rose Ø200x55mm

⊕ ⊖ IP20 CE



**CHO008**

LED 60W - Ø800mm  
3000K 6580 lm



cavo cable L.max 1200mm  
rosone ceiling rose Ø280x80mm

⊕ ⊖ IP20 CE



Ø 450 / 600 / 800

85

**CHO004**

LED 60W  
3000K 6580 lm



cavo cable L.max 1200mm  
rosone ceiling rose 240x240x42mm

⊕ ⊖ IP20 CE



800

800

85









# ASIA

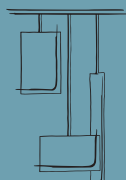

Elegante sospensione a forma conica in metallo verniciato a polveri, disponibile in finitura bianca o nera, con interno bianco o oro satinato. Disponibile in versione singola (cavo di sospensione nero o trasparente), con kit decentramento a tre o cinque elementi (cavo in tinta con il corpo lampada) o con possibilità di decentramento dal punto luce, con effetto di disegno sulla superficie di montaggio. Cablata con attacco E27 che consente di montare lampadina LED.

Elegant pendant lamp of conical shape in power painted metal, available in black or white finish, with interior in white or satin gold finish. Available in single version (clear or black cable), with decentralization kit for three or five luminaires (cable in the same colour of the body) and with decentralization from light source, creating patterns on the installation surface. E27 lamp holder that allows mounting the LED lamp.





**ASIO01**

E27 1x75W max

cavo cable L.max 1100mm

rosone ceiling rose Ø100x35mm

⊕ ⊖ IP20 CE

B BOS NB N



compatibile con lampadine LED con tecnologia smart (pag. 730)  
suitable for smart LED light bulbs (pag. 730)

Il codice colore -N si riferisce al diffusore nero con interno oro, -NB diffusore nero con interno bianco.  
Colour code -N refers to black diffuser with gold internal finish, -NB black diffuser with white internal finish.

**CORPO DIFFONDENTE / DIFFUSER BODY**



**ASI002**

E27 1x75W max  
cavo cable L.max 5000mm



⊕ ⚡ IP20 CE B BOS NB N



compatibile con lampadine LED con tecnologia smart (pag. 730)  
suitable for smart LED light bulbs (pag. 730)

Il codice colore -N si riferisce al diffusore nero con interno oro, -NB diffusore nero con interno bianco.  
Colour code -N refers to black diffuser with gold internal finish, -NB black diffuser with white internal finish.

**KIT DECENTRAMENTO / MULTIPLE COMPOSITION KIT**



**MT.31**

nottolino singolo  
single hook

B N



**KITDEC201**

KIT decentramento a parete per  
spostamento punto luce  
wall lamp KIT for decentralization  
from light source

B N



**KITDEC101**

KIT decentramento 1 elemento  
1 lamp KIT

B N



**KITDEC103**

KIT decentramento 3 elementi  
3 lamps KIT

B N



**KITDEC105**

KIT decentramento 5 elementi  
5 lamps KIT

B N



esempio di composizione composition example  
KITDEC103N + 3 x ASI002NB



esempio di composizione composition example  
KITDEC201N + 1 x ASI002N



esempio di composizione composition example  
KITDEC105B + 5 x ASI002BOS



# ARGO



Apparecchio a soffitto con attacco GU10 che consente di montare lampadina LED. Struttura tonda o quadrata in pressofusione di alluminio verniciato con polveri epossidiche ad elevata resistenza. Disponibile in cinque finiture (bianco, grigio, nero, bianco e nero con interno oro satinato).

Ceiling lamp with GU10 lamp holder that allows mounting LED lamp. Round or square die-cast aluminium body, painted with high resistant epoxy powders. Available in five finishes (white, grey, black, white and black with internal satin gold finish).



**ARG002**

GU10 35W max



⊕ ⊖ IP20 CE

B BOS GR N NOS



**ARG001**

GU10 35W max



⊕ ⊖ IP20 CE

B BOS GR N NOS

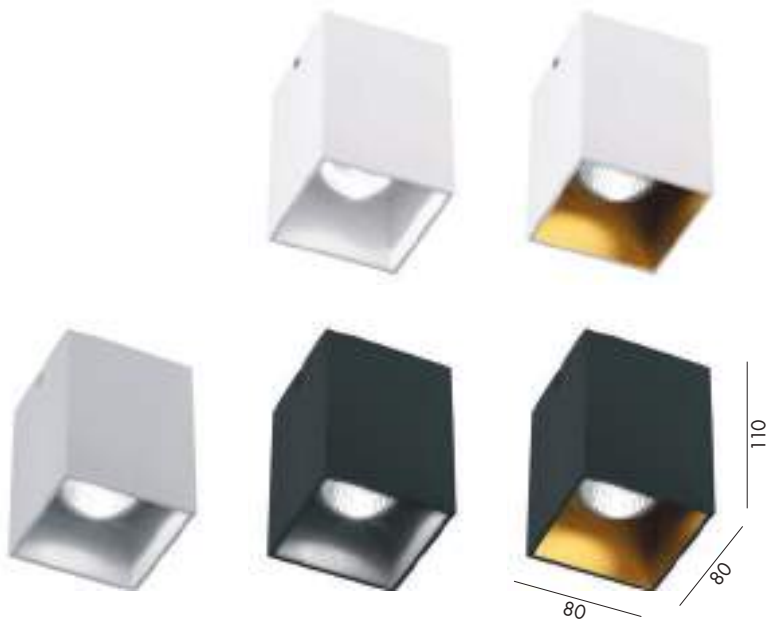

Personalizzabile nella colorazione della struttura in alluminio.  
Colour of the aluminium body available upon request.



ORO ARG RA







# ARGO PLASTER



Apparecchio a soffitto con attacco GU10 che consente di montare lampadina LED. Struttura in gesso che consente la pittura del corpo in tinta a scelta; disponibile in forma tonda o quadrata. Adatto all'installazione in luoghi di passaggio e corridoi e laddove non è possibile montare un prodotto ad incasso.

Ceiling lamp in smooth plaster, GU10 lamp holder, that allows mounting LED lamp. Free chance to paint the plaster body surface as desired. Available in round and square shape. It is suitable for installation in corridors and hallways and wherever recessed mounting is not possible.



**ARG003**

GU10 1x35W max



□ ▽ IP20 CE



**ARG004**

GU10 1x35W max



□ ▽ IP20 CE



corpo verniciabile in finitura colore a scelta  
paint the plaster body surface as desired



# LOTUS

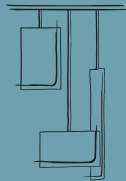

Lampada a sospensione in alluminio verniciato a LED (3000K), dalla forma tondeggianti e asimmetrica. Corpo alto solo 4 cm, che permette l'applicazione del prodotto in ambienti con altezze contenute; diffusore in acrilico che consente un'ottima diffusione della luce. Disponibile in versione bianca e nera, con rosone in tinta e cavi in acciaio.

Pendant LED (3000K) lamp in painted aluminum, with a rounded and asymmetrical shape. Only 4 cm flat body which allows its application in environments with limited heights. Acrylic diffuser for diffused light emission. Available in white and black finishes, ceiling rose in the same colour and steel cables.





43



602x590



**LOU001**

LED 36W

3000K 3200 lm

cavo cable L.max 800mm

rosone ceiling rose Ø190x51mm



⊕ ⊖ IP20 CE





# IKU

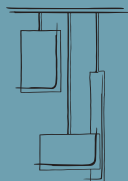

Lampada a sospensione con sorgente LED integrata (3000K). Corpo in alluminio estruso, colore bianco goffrato, verniciatura a polveri epossidiche. Diffusore in policarbonato opale. Disponibile in forma quadrata o rettangolare in diverse dimensioni e relative potenze e in versione dimmerabile DALI.

Pendant LED lamp (3000K) with extruded aluminium body, matt white epoxy powder coating. Opal polycarbonate diffuser. Available in rectangular or square shape, in different sizes and related powers and in dimmable DALI version.



MADE IN  
MILANO



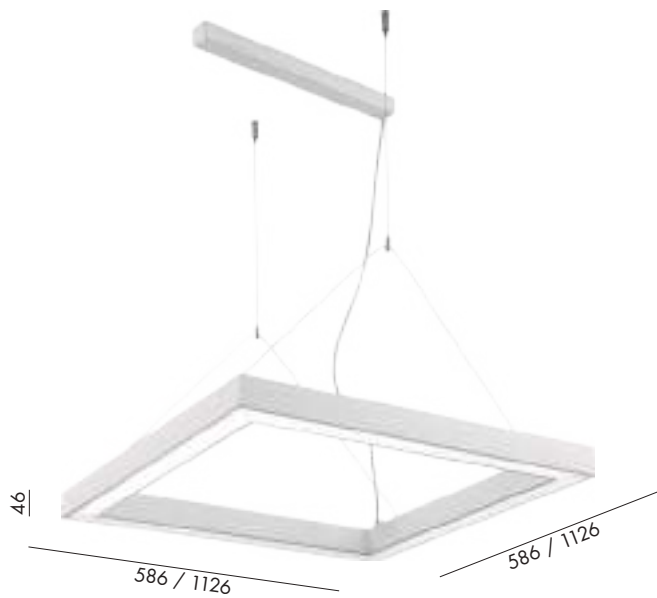

**IKU001B**

LED 48W - L.586 mm  
3000K 7110 lm



**IKU001BDA**

LED 48W  
3000K 7110 lm



**IKU003B**

LED 96W - L.1126 mm  
3000K 14215 lm



**IKU003BDA**

LED 96W  
3000K 14215 lm



cavo cable L.max 1500mm  
rosone ceiling rose 350x40x30mm

⊕ ⊖ IP20 CE

**IKU005B**

LED 64W - L.1156 mm  
3000K 9480 lm



**IKU005BDA**

LED 64W  
3000K 9480 lm



**IKU007B**

LED 96W - L.1696 mm  
3000K 14215 lm



**IKU007BDA**

LED 96W  
3000K 14215 lm



cavo cable L.max 1500mm  
rosone ceiling rose 350x40x30mm

⊕ ⊖ IP20 CE



# SMOOTH

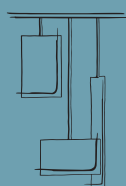

Lampada a sospensione a LED (3000K), biemissione, composta da uno schermo in PMMA trasparente racchiuso in una sottile cornice in alluminio bianco (h.16mm) in cui sono alloggiati i LED. La luce viene convogliata lungo la superficie diffondente grazie ad una micro-incisione a laser effettuata nel PMMA che garantisce un illuminamento omogeneo e privo di abbagliamento (UGR<19). Disponibile in versione On-Off, DALI e con interfaccia Casambi.

LED pendant lamp (3000K), with direct-indirect light, composed by a transparent PMMA screen enclosed in a thin white aluminum frame (h.16mm) in which the LEDs are housed. The light is conveyed along the diffusing surface thanks to a laser micro-incision made in the PMMA which guarantees a homogeneous and glare-free illumination (UGR <19). Available in On-Off, DALI and with Casambi interface.



MADE IN  
MILANO

**SMO001**

LED 80W  
3000K 9500 lm



**SMO001CA**

LED 80W  
3000K 9500 lm



**SMO001DA**

LED 80W  
3000K 9500 lm



cavo cable L.max 1500mm  
rosone ceiling rose 350x40x30mm

⊕ ⊖ IP20 CE







# DRAM



Lampada a soffitto e a sospensione con sorgente LED (3000K) con emissione diretta proposta in forma tonda o quadrata, in diverse misure e relative potenze, verniciata a polvere nei colori bianco opaco e nero opaco. Corpo in lamiera di acciaio molto sottile (spessore 2,5mm). Alimentatore dimmerabile (DALI) integrato.

Square or round LED pendant and ceiling lamp (3000K) with direct light. Available in different sizes and related powers, painted in matt white and matt black colours. Ultra-thin 2,5mm steel sheet body. Dimmable DALI integrated LED driver.



MADE IN  
MILANO



**DRA010**

LED 48W  
3000K 5500 lm



**DRA010XCA**

LED 48W  
3000K 5500 lm



cavo cable L.max 1500mm  
rosone ceiling rose 195x100x40mm

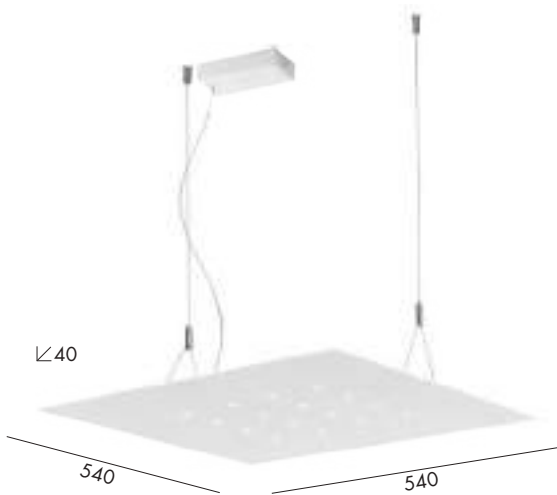

**DRA001**

LED 48W  
3000K 5500 lm



**DRA001XCA**

LED 48W  
3000K 5500 lm



cavo cable L.max 1500mm  
rosone ceiling rose 195x100x40mm



**DRA003**

LED 48W  
3000K 5500 lm



**DRA003XCA**

LED 48W  
3000K 5500 lm



cavo cable L.max 1500mm  
rosone ceiling rose 195x100x40mm



∠45



**DRA009**

LED 48W  
3000K 5500 lm



**DRA009XCA**

LED 48W  
3000K 5500 lm



∠45

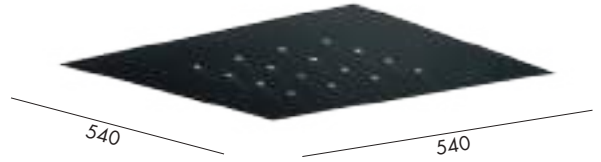

**DRA005**

LED 48W  
3000K 5500 lm



**DRA005XCA**

LED 48W  
3000K 5500 lm





# SPINNAKER

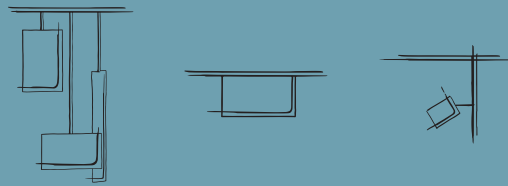

Lampada a sospensione, a soffitto e a parete di forma quadrata con attacco GX53 che consente di montare lampadina LED. Proposta nella versione con uno, quattro o sei portalampada, la luce esce dai fori circolari nella struttura (sospensione anche in versione biemissione). Corpo in metallo (spessore 2mm) verniciato a polveri in finitura bianca e sabbia. Prodotto molto versatile e in virtù della sua sottigliezza è ideale per l'installazione nelle abitazioni moderne, anche in applicazioni multiple creando composizioni personalizzate nei colori e nella disposizione degli elementi (tramite intervento di personale specializzato).

Pendant, ceiling and wall lamp with direct light and a square shape, with GX53 lamp holder that allows mounting LED lamp. Available in the version with one or four lamp holders, the light comes out of the circular holes in the structure. Powder-coated metal body (2mm thick) in white and sand colours. Very versatile product: due to its thinness is ideal for installation in modern homes and in multiple compositions, customized in the colors and in the arrangement of the elements (through the help of specialized personnel).

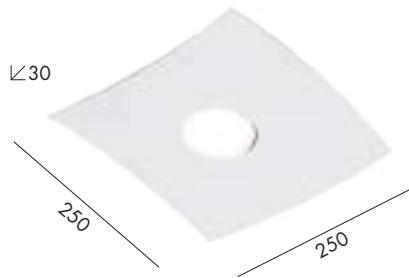

**SPN001**  
GX53 1x8W LED



⊕ ⊖ IP20 CE

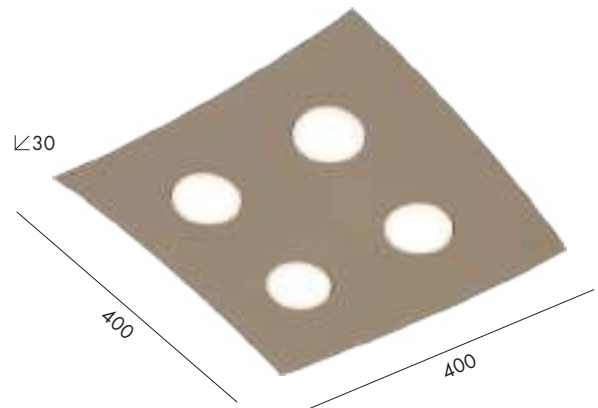

**SPN002**  
GX53 4x8W LED



⊕ ⊖ IP20 CE





400 x 400

∠30



400 x 400

∠30

**SPN003**

GX53 4x8W LED

cavo cable L.max 1200mm

rosone ceiling rose 120x120x20mm



⊕ ▽ IP20 CE



**SPN004**

GX53 6x8W LED

cavo cable L.max 1200mm

rosone ceiling rose 120x120x20mm



⊕ ▽ IP20 CE







# PUZZLE

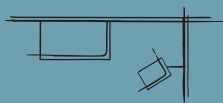

Come gli elementi di un puzzle, anche in questa lampada a soffitto e parete a luce diretta dalla particolare e divertente forma, più apparecchi si possono accostare tra loro, creando composizioni personalizzate nei colori e nella disposizione degli elementi (tramite intervento di personale specializzato). Cablata con attacco GX53 che consente di montare lampadine LED. E' composta da una struttura in metallo verniciato a polveri disponibile in quattro finiture: bianco, nero, rosso e azzurro. Il prodotto ideale per illuminare con allegria la cameretta e gli spazi dedicati a bambini e adolescenti.

Like the single elements of a puzzle, even in this ceiling and wall lamp with direct light and a particular and fun shape, several lamps can be placed side by side, creating customised compositions in the colours and arrangement of the elements (through the help of specialized personnel). GX53 lamp holder that allows mounting LED lamp. It consists of a powder-coated metal structure available in four colours: white, black, red and blue. The ideal lamp to light up the bedroom and the spaces dedicated to children and teenagers.



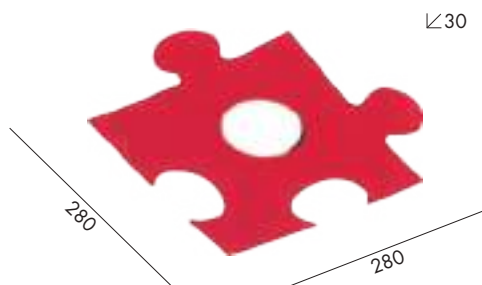

**PUZ001**

GX53 1x8W LED



⊕ ▽ IP20 CE





# KAHLO

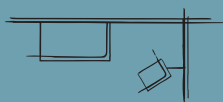

Lampada da parete e da soffitto con sorgente LED (2700K). Struttura tondeggiante in pressofusione di alluminio (spessore 1 mm) verniciata a polveri. Disponibile in quattro misure (versione mini, small, medium e large) che si possono montare singolarmente o accostare in composizioni, da due, tre, quattro o cinque elementi (vedi schema di montaggio pag.176-177). Proposta in tre finiture (bianca, nera e oro satinato) che si prestano per composizioni uniche e personalizzate. La tecnica di fissaggio a calamita dei singoli elementi facilita il montaggio e la pulizia del prodotto.

LED wall and ceiling lamp (2700K). Die-cast aluminium structure powder coated with a rounded shape (1 mm thick). Available in four sizes (mini, small, medium and large versions) that can be single-mounted or composed by two, three, four or five elements combined together (see composition example pg.176-177). Available in three finishes (white, black or satin gold) that make unique and custom compositions possible. Luminaires are magnet mounted to the structure, allowing easy installation and maintenance.

## KAHLO MINI

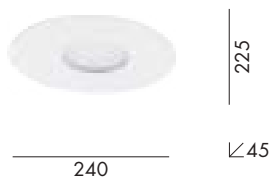

### KAH101B

LED 1x17W  
2700K 1600 lm



⊕ ⊖ IP20 CE

### KAH101N

### KAH101OS

### MONTAGGIO SINGOLO / SINGLE MOUNTING

Completare i corpi illuminanti con la staffa di fissaggio  
All fittings must be completed with the connection bracket

Ø 150



### KAH101MT

### ESEMPIO DI COMPOSIZIONE / COMPOSITION EXAMPLE

**KAH101B + KAH101MT**

## KAHLO SMALL



### KAH102B

LED 1x17W  
2700K 1600 lm



⊕ ⊖ IP20 CE

### KAH102N

### KAH102OS

### MONTAGGIO SINGOLO / SINGLE MOUNTING

Completare i corpi illuminanti con la staffa di fissaggio  
All fittings must be completed with the connection bracket

Ø 150



### KAH101MT

### ESEMPIO DI COMPOSIZIONE / COMPOSITION EXAMPLE

**KAH102N + KAH101MT**

## KAHLO MEDIUM



### KAH103B

LED 1x17W  
2700K 1600 lm



### KAH103N

### KAH103OS

⊕ ▽ IP20 CE

### MONTAGGIO SINGOLO / SINGLE MOUNTING

Completare i corpi illuminanti con la staffa di fissaggio  
All fittings must be completed with the connection bracket

ESEMPIO DI COMPOSIZIONE / COMPOSITION EXAMPLE

**KAH103OS + KAH101MT**

Ø 150



### KAH101MT

## KAHLO LARGE



### KAH104B

LED 1x17W  
2700K 1600 lm



### KAH104N

### KAH104OS

⊕ ▽ IP20 CE

### MONTAGGIO SINGOLO / SINGLE MOUNTING

Completare i corpi illuminanti con la staffa di fissaggio  
All fittings must be completed with the connection bracket

ESEMPIO DI COMPOSIZIONE / COMPOSITION EXAMPLE

**KAH104B + KAH101MT**

Ø 150



### KAH101MT

**STRUTTURA A 2 ELEMENTI 2 ELEMENTS STRUCTURE**

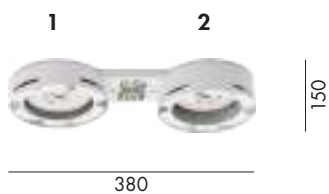

**KAH102MT**



**POSSIBILITÀ DI COMPOSIZIONE POSSIBLE MATCHING**

**1** KAHLO MINI  
KAHLO SMALL

**2** KAHLO MEDIUM  
KAHLO LARGE

ESEMPIO DI COMPOSIZIONE / COMPOSITION EXAMPLE

**KAH102OS + KAH104N + KAH102MT**

**STRUTTURA A 3 ELEMENTI 3 ELEMENTS STRUCTURE**

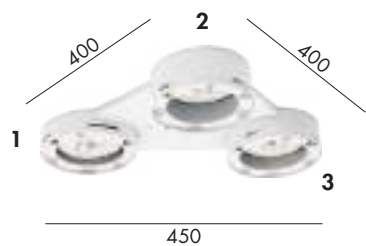

**KAH103MT**

**POSSIBILITÀ DI COMPOSIZIONE POSSIBLE MATCHING**

**1** KAHLO MINI

**2** KAHLO SMALL

**3** KAHLO SMALL

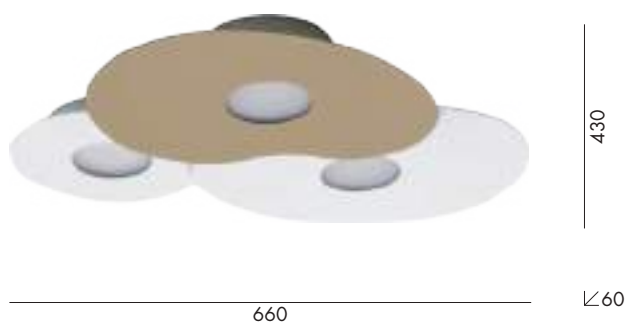

ESEMPIO DI COMPOSIZIONE / COMPOSITION EXAMPLE

**KAH101B + KAH102OS + KAH102B + KAH103MT**



STRUTTURA A 4 ELEMENTI 4 ELEMENTS STRUCTURE



KAH104MT

POSSIBILITÀ DI COMPOSIZIONE POSSIBLE MATCHING

1 KAHLO LARGE

2 KAHLO SMALL

3 KAHLO MEDIUM

4 KAHLO MINI



ESEMPIO DI COMPOSIZIONE  
COMPOSITION EXAMPLE

KAH104B + KAH101B + KAH103B +  
KAH102B + KAH104MT

STRUTTURA A 5 ELEMENTI 5 ELEMENTS STRUCTURE

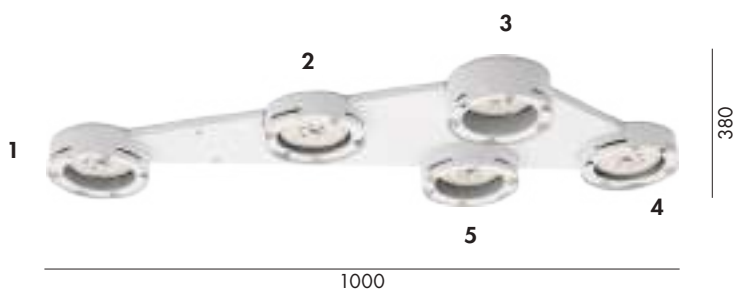

KAH105MT

POSSIBILITÀ DI COMPOSIZIONE POSSIBLE MATCHING

1 KAHLO LARGE

2 KAHLO MEDIUM

3 KAHLO SMALL

4 KAHLO MEDIUM

5 KAHLO MINI

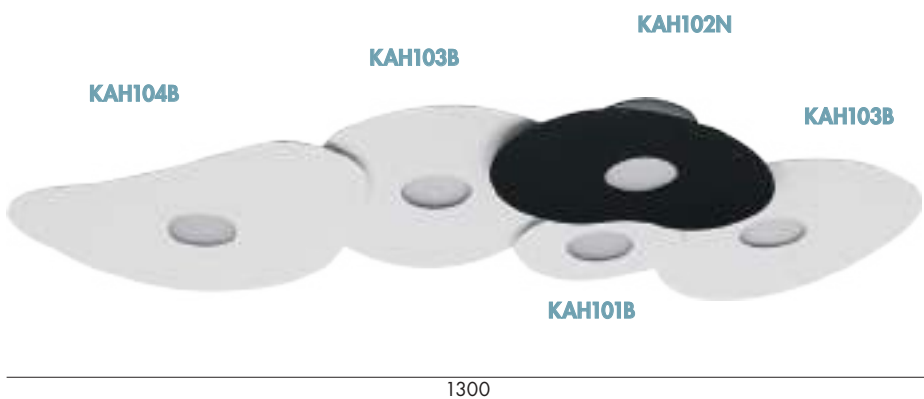

ESEMPIO DI COMPOSIZIONE  
COMPOSITION EXAMPLE

KAH104B + KAH103B + KAH102N +  
KAH103B + KAH101B + KAH105MT





Personalizzabile nella colorazione della struttura in alluminio.  
Colour of the aluminium body available upon request.

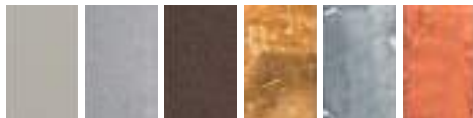

T GR MA ORO ARG RA





# BUBBLES

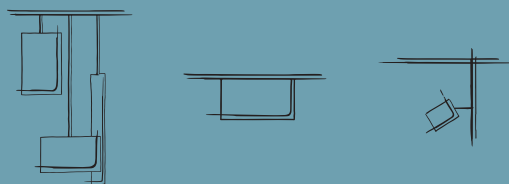

Lampada a sospensione, a soffitto e a parete con sorgente LED (2700K), struttura ovale in pressofusione di alluminio (spessore 1mm) verniciata a polveri nei colori bianco, nero e tortora. Composta da tagli tondi nella struttura da cui fuoriesce la luce: proposta in diverse misure e con diversi tagli (due, tre, quattro o cinque).

LED pendant, ceiling and wall lamp, die-cast aluminium oval structure (1mm thick), powder painted in white, black or dove-grey colour. Featuring round slits in the structure that filter the light: available in different sizes and slits (two, three, four or five).

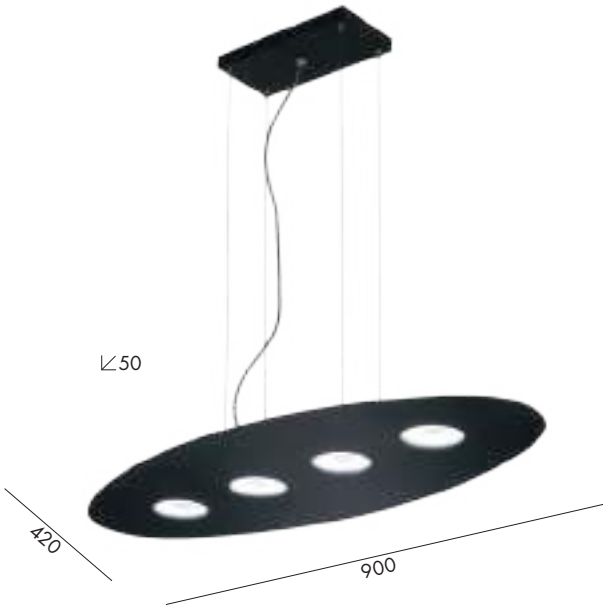

**BUB005**

LED 68W

2700K 6400 lm

cavo cable L.max 1200mm

rosone ceiling rose 280x130x25mm



⊕ ⊖ IP20 CE



**BUB001**

LED 34W

2700K 3200 lm



⊕ ⊖ IP20 CE

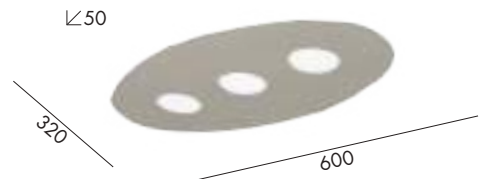

**BUB002**

LED 51W

2700K 4800 lm



⊕ ⊖ IP20 CE

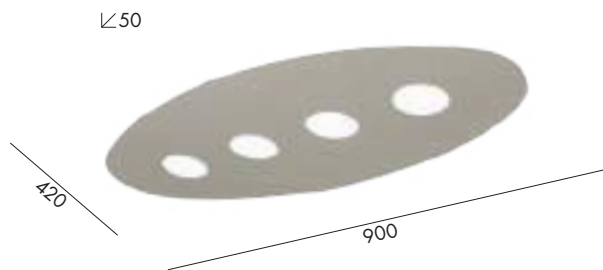

**BUB003**

LED 68W

2700K 6400 lm



⊕ ⊖ IP20 CE



**BUB004**

LED 85W

2700K 8000 lm



⊕ ⊖ IP20 CE





Personalizzabile nella colorazione della struttura in alluminio.  
Colour of the aluminium body available upon request.



GR MA OS ORO ARG RA







# PONYO

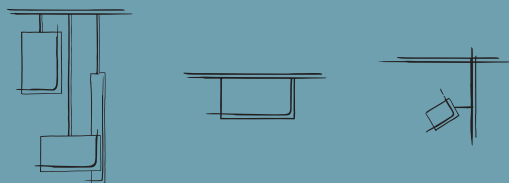

Lampada a sospensione, da parete e a soffitto con sorgente LED (2700K); la luce esce dai tagli rettangolari nella struttura. Struttura squadrata in pressofusione di alluminio (spessore 1 mm) verniciata a polveri nei colori bianco, nero e tortora. Prodotto molto sottile, ideale per l'installazione nelle abitazioni moderne.

LED pendant, wall and ceiling lamp (2700); the light is emitted from the rectangular slits in the structure. Die-cast aluminium square structure (1 mm thick), powder painted in white, black or dove-grey colour. Very thin lamp, ideal to be installed in modern homes.

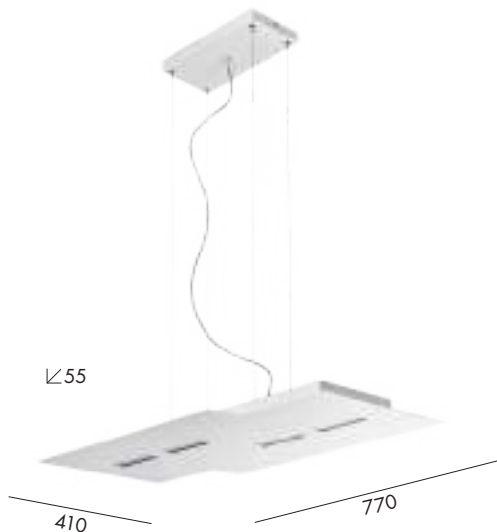

**PON006**     
 LED 52W  
 2700K 4800 lm  
 cavo cable L.max 1200mm  
 rosone ceiling rose 280x130x25mm

---

     

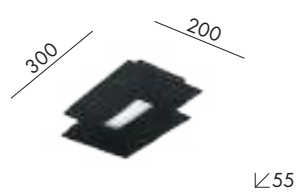



**PON001**     
 LED 13W  
 2700K 1200 lm



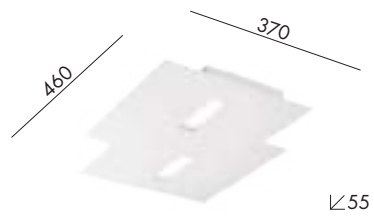



---

     





**PON002**     
 LED 26W  
 2700K 2400 lm



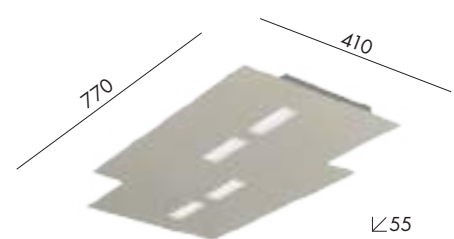



---

     



**PON003**     
 LED 52W  
 2700K 4800 lm

---

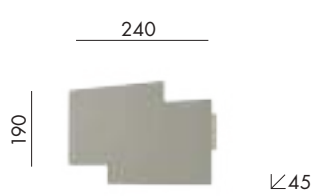

**PON004**     
 LED 13,5W  
 2700K 1250 lm  
 monoemissione direct light

---



**PON005**     
 LED 2x13,5W  
 2700K 2500 lm  
 biemissione direct-indirect light

---

     



Personalizzabile nella colorazione della struttura in alluminio.  
Colour of the aluminium body available upon request.



GR MA OS ORO ARG RA

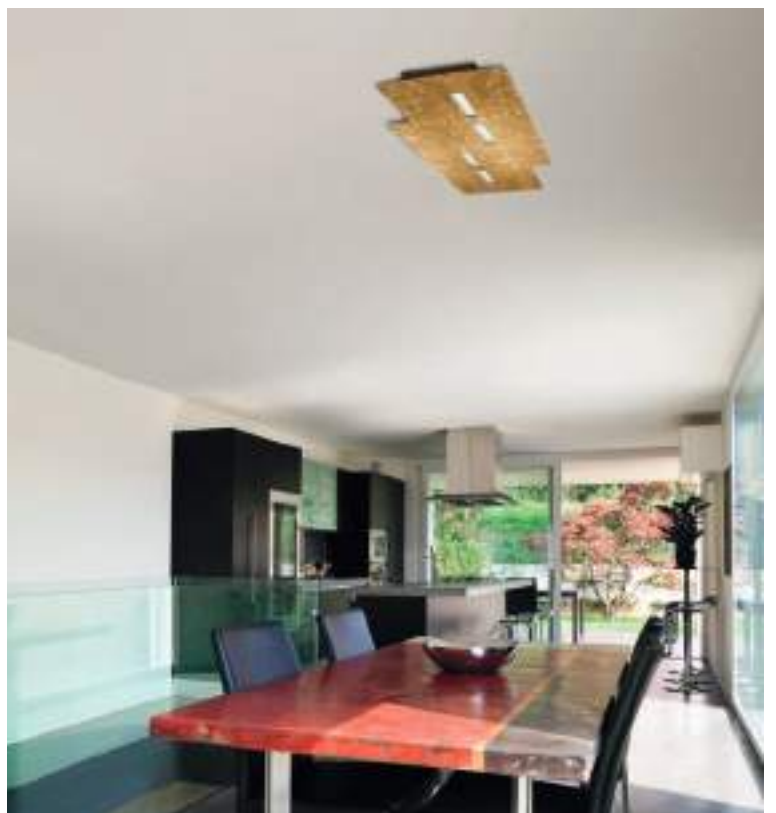



# WEDGE

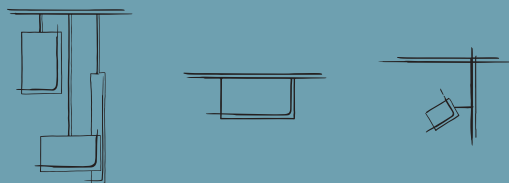

Lampada a sospensione, da parete e a soffitto con sorgente LED (2700K); la luce esce dai tagli quadrati nella struttura (diversi a seconda delle dimensioni). Struttura in pressofusione di alluminio (spessore 1mm) verniciata a polveri nei colori bianco e tortora. Prodotto molto sottile, ideale per l'installazione nelle abitazioni moderne.

LED pendant, wall and ceiling lamp (2700K); the light is emitted from the slits in the structure (different according to the sizes). Die-cast aluminium structure (1mm thick), powder painted in white and dove-grey colour. Very thin lamp, ideal to be installed in modern homes.

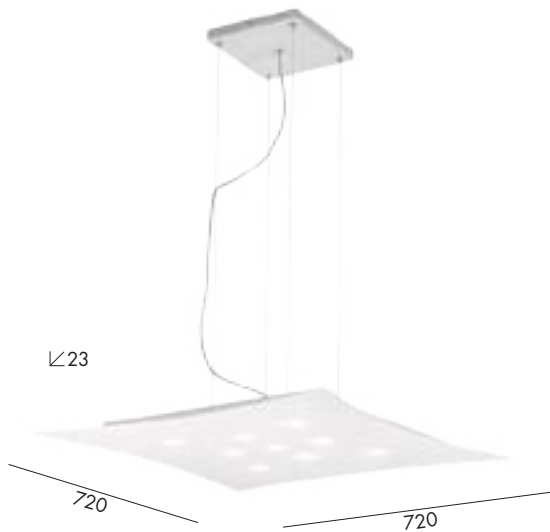

**WED006**

LED 45W  
2700K 4050 lm  
cavo cable L.max 1200mm  
rosone ceiling rose 230x230x25mm



⊕ ⊖ IP20 CE

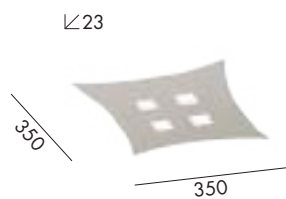

**WED001**

LED 20W  
2700K 1800 lm



⊕ ⊖ IP20 CE

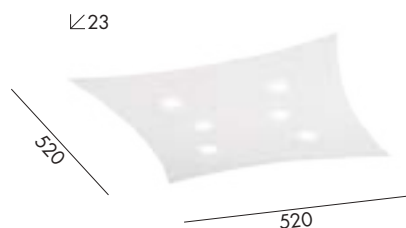

**WED002**

LED 30W  
2700K 2700 lm



⊕ ⊖ IP20 CE

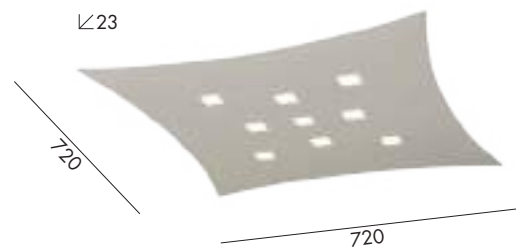

**WED003**

LED 45W  
2700K 4050 lm



⊕ ⊖ IP20 CE



**WED004**

LED 13,5W  
2700K 1250 lm  
monoemissione direct light



⊕ ⊖ IP20 CE



**WED005**

LED 2x13,5W  
2700K 2500 lm  
biemissione direct-indirect light



⊕ ⊖ IP20 CE





Personalizzabile nella colorazione della struttura in alluminio.  
Colour of the aluminium body available upon request.



N GR MA OS ORO ARG RA







# DAISHO



Lampada a parete a luce indiretta con sorgente LED (2700K), dalla forma lineare e semplice. Realizzata con un corpo cilindrico in alluminio, orientabile (max 350°), fissato ad una struttura circolare che si installa a parete, in cui è alloggiato l'alimentatore. Disponibile nelle finiture bianco, nero, bronzo e nickel satinato, si presta a composizioni multiple con particolari effetti di luce sulla superficie di installazione. Adatto ad installazioni sopra specchi, quadri, disposto in verticale o orizzontale.

Wall lamp with LED source (2700K) and indirect light emission, with a linear and simple shape. Composed by a cylindrical aluminum body, adjustable (max 350°), fixed to a circular structure that is installed on the wall, with driver inside. Available in white, black, bronze and satin nickel colours, ideal for multiple compositions with particular light effects on the installation surface. Suitable for installations above mirrors, paintings, arranged vertically or horizontally.





**DAS001**

LED 12W

2700K 1000 lm

attacco a parete wall support Ø70x80mm



□ ▽ IP20 CE

□ B N BZ NS







# ENSO



Lampada a parete con sorgente LED integrata (3000K) dalla linea minimal e dalle prestazioni ottimali. La luce diretta è emessa dalla superficie interna di un anello orientabile (max 350°) applicato su una struttura in pressofusione di alluminio, entrambi verniciate a polveri nei colori bianco e nero. Enso, una volta accesa, crea due semicerchi di luce contrapposti; in fase di installazione, con l'utilizzo di più apparecchi, si possono creare infiniti giochi di luce. Prodotto dalle dimensioni contenute ideale per l'installazione in luoghi di passaggio, nelle abitazioni moderne.

Wall lamp with integrated LED source (3000K) with a minimal design and optimal light performance. The direct emission comes from the inner surface of an adjustable ring (max 350°) fixed on a die-cast aluminum structure, both parts powder-coated in black or white finish. Once turned on, Enso creates two opposite semicircles of light; during the installation, using more luminaires, it is possible to create infinite light effects. Product with small dimensions, ideal to be installed in transit areas, in stylish homes.







Ø 152



**ENS001**

LED 7W

3000K 800 lm



⊕ ⚡ IP20 CE





# SUNSET



Lampada a parete a luce indiretta con sorgente LED integrata (2700K). Disponibile in due diametri (200 e 300mm) e relative potenze, nei colori bianco e nero. Diffusore in metracrilato per un'omogenea diffusione della luce, sormontato da una lastra in alluminio verniciato. L'accostamento di più apparecchi (grazie alle diverse profondità delle due misure) permette eleganti contrasti di luce e colore sulla superficie di installazione, per impreziosire la zona giorno o la camera da letto.

Wall lamp with indirect light emission with integrated LED source (2700K). Available in two diameters (200 and 300mm) with related powers, in white and black finish. Methacrylate diffuser for a uniform light emission, crested by a painted aluminum plate. The combination of several lamps (thanks to the different depths of the two sizes) allows elegant contrasts of light and colour on the installation surface, to decorate the living area or the bedroom.





**SUN001**

LED 9W  
2700K 680 lm



□ ▽ IP20 CE



**SUN002**

LED 16W  
2700K 1300 lm



□ ▽ IP20 CE





# BALA



Lampada da parete e da terra a luce indiretta di forma tondeggiante con sorgente LED integrata (2700K). Struttura in alluminio ad alto spessore lavorato dal pieno verniciato a polveri. Disponibile in tre finiture: bianco, nero e tortora.

LED wall and floor lamp with indirect light emission (2700K) and rounded shape. Die-cast aluminium structure worked from solid, powder painted. Available in three finishes (white, black and dove-grey).



**BAA001**

LED 27W

2700K 2500 lm

⊕ ⊖ IP20 CE

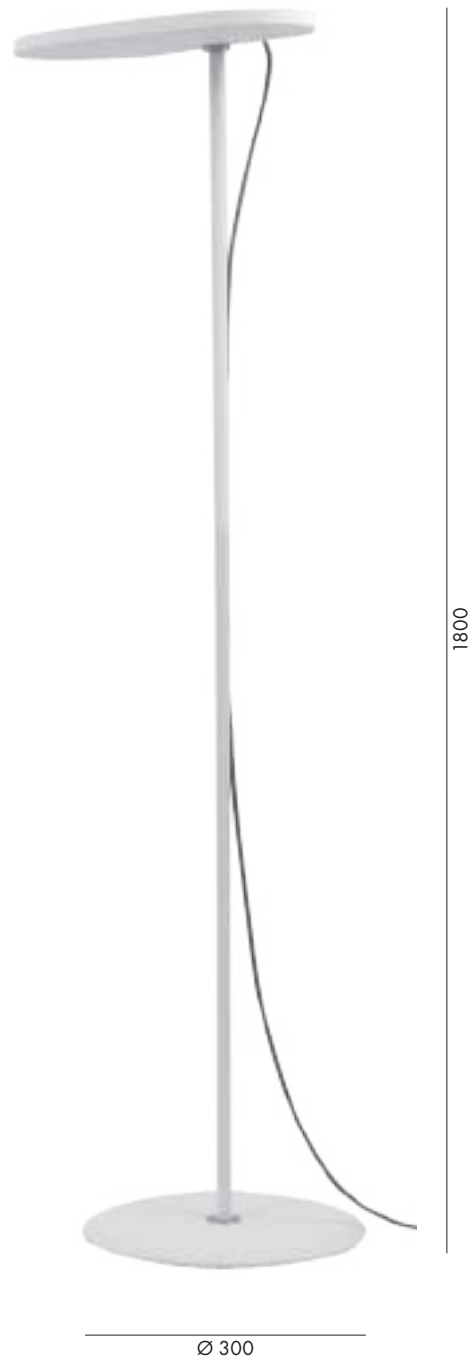

**BAA003**

LED 40,5W

2700K 3750 lm

⊕ ⊖ IP20 CE



Personalizzabile nella colorazione della struttura in alluminio.  
Colour of the aluminium body available upon request.



GR MA OS CR



# BEN



Lampada da parete a luce indiretta di forma squadrata con sorgente LED integrata (2700K). Struttura in alluminio ad alto spessore lavorato dal pieno verniciato a polveri. Disponibile in tre finiture: bianco, nero e cromo.

LED wall lamp with indirect light emission (2700K) and square shape. Die-cast aluminium structure worked from solid, powder painted. Available in three finishes (white, black and chrome).





**BEN001**

LED 27W

2700K 2500 lm



⊕ ⊖ IP20 CE

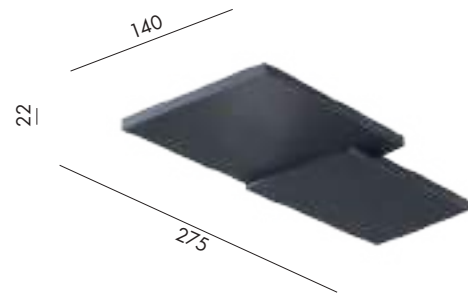

Personalizzabile nella colorazione della struttura in alluminio.  
Colour of the aluminium body available upon request.



T GR MA OS





# ARDBEG

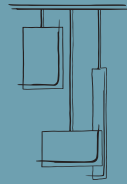

Lampada a sospensione composta da un prezioso diffusore in vetro trasparente soffiato a mano, dalla forma cilindrica e con una particolare lavorazione del vetro romboidale. Disponibile in tre finiture (trasparente, fumè e blu), proposta in versione singola o con rosone per cadute multiple a tre elementi. Cablato con attacco E27 con lampadina visibile in virtù della trasparenza del prodotto, che consente all'utente di montare una lampadina a sua scelta, personalizzando ulteriormente il prodotto.

Pendant lamp composed by a fine diffuser in hand-blown transparent glass, with a cylindrical shape and a particular diamond-shaped glass processing. Available in three finishes (transparent, smoky grey and blue), proposed in single version or with ceiling rose for multiple pendants (three slots). E27 lamp holder with visible lamp, due to the transparency of the glass, that allows the user to mount a light bulb of his choice and further personalize the product.



**ARB101**

E27 1x75W max  
cavo cable L.max 1200mm



⊕ ⊖ IP20 CE

CRI FU BLU

da completare con kit decentramento anche nella versione singola to be completed with decentralization kit even in the single version

**KIT DECENTRAMENTO / DECENTRALIZATION KIT**



**ROS202CR**

KIT decentramento 1 elemento  
1 lamp KIT



**ROS203CR**

KIT decentramento 3 elementi  
3 lamps KIT



esempio di composizione composition example  
ROS203CR + 2 x ARB101CRI + 1 x ARB101BLU









# OBAN

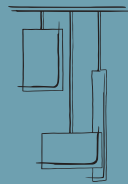

Lampada a sospensione composta da un prezioso diffusore in vetro trasparente soffiato a mano, dalla forma tondeggiante e martellato sulla superficie, con un effetto particolare che movimentata le linee del prodotto e crea particolari effetti di luce sulla superficie di installazione. Disponibile in tre finiture (trasparente, fumè e blu), proposta in versione singola o con rosone per cadute multiple a tre elementi. Cablato con attacco E27 con lampadina visibile in virtù della trasparenza del prodotto, che consente all'utente di montare una lampadina a sua scelta, personalizzando ulteriormente il prodotto.

Pendant lamp composed of a fine diffuser in hand-blown transparent glass, with a rounded shape and hammered on the surface, with a particular effect that moves the product lines and creates special light effects on the installation surface. Available in three finishes (transparent, smoky grey and blue), proposed in single version or with ceiling rose for multiple pendants (three slots). E27 lamp holder with visible lamp, due to the transparency of the glass, that allows the user to mount a light bulb of his choice and further personalize the product.



**OBA101**

E27 1x75W max  
cavo cable L.max 1200mm



⊕ ⚡ IP20 CE CRI FU BLU

da completare con kit decentramento anche nella versione singola to be completed with decentralization kit even in the single version

**KIT DECENTRAMENTO / DECENTRALIZATION KIT**

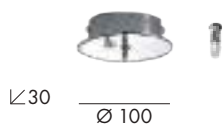

**ROS202CR**  
KIT decentramento 1 elemento  
1 lamp KIT



**ROS203CR**  
KIT decentramento 3 elementi  
3 lamps KIT



esempio di composizione composition example  
ROS203CR + 2 x OBA101CRI + 1 x OBA101FU







# TALISKER

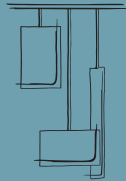

Lampada a sospensione composta da un prezioso diffusore in vetro trasparente soffiato a mano, proposto in forma quadrata o ovale, entrambe con delle lavorazioni effettuate sul vetro, che movimentano le linee del diffusore e creano particolari effetti di luce sulla superficie di installazione. Disponibile in quattro finiture (trasparente, fumè, blu e azzurro tiffany), in versione singola o in cadute multiple, sia con rosone (a tre e sei feritoie) che con kit decentramento (a tre o cinque elementi), che consentono di creare infinite composizioni di prodotto, accostando le due forme e le quattro colorazioni. Cablato con attacco E14, che consente di montare lampadina LED.

Pendant lamp composed by a fine diffuser in hand-blown transparent glass, proposed in square or oval shape, with decorations made on the glass that move the lines of the diffuser and create special light effects on the installation surface. Available in four finishes (transparent, smoky grey, blue and tiffany blue), in single version or in multiple composition, both with ceiling rose (three or six slots) and with free disposal with decentralization kit (three or five luminaires) that allow to create infinite compositions, combining the two shapes and the four colours. E14 lamp holder that allows mounting LED lamp.

CORPI DIFFONDENTI / DIFFUSER BODIES



**TAI101**

E14 1x28W max  
cavo cable L.max 2000mm



⊕ ⊖ IP20 CE

CRI FU AZ BLU



**TAI102**

E14 1x28W max  
cavo cable L.max 2000mm



⊕ ⊖ IP20 CE

CRI FU AZ BLU

da completare con kit decentramento anche nella versione singola to be completed with decentralization kit even in the single version



## KIT DECENTRAMENTO / DECENTRALIZATION KIT



### KITDECO01

KIT decentramento 1 elemento  
1 lamp KIT



### KITDECO03

KIT decentramento 3 elementi  
3 lamps KIT

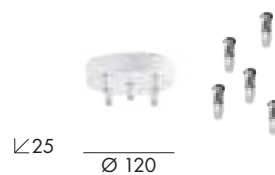

### KITDECO05

KIT decentramento 5 elementi  
5 lamps KIT



---

## ROSONI / CEILING ROSES

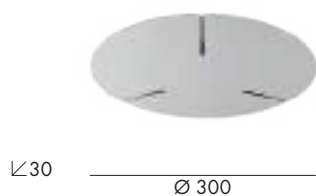

### MT.ROS003F

Rosone a 3 uscite  
Three-way ceiling rose



### MT.ROS006F

Rosone a 6 uscite  
Six-way ceiling rose













# GIOIA

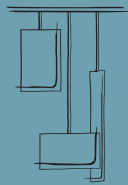

Gioia unisce ricerca estetica, tecnologica e funzionale a un elegante gioco di trasparenze e nuances di colore, per dare un tocco di personalità all'ambiente. Proposta nella versione singola o in cadute multiple (sia con rosone che con kit decentramento) da comporre con cavo in PVC trasparente o in tessuto (disponibile nei colori rosso, nero o verde militare). È caratterizzata da una raffinata forma ovale leggermente schiacciata in vetro pyrex, sabbato all'interno. I diffusori sono disponibili in cristallo trasparente, cromo sfumato, bronzo lucido e oro lucido (ottenuto grazie alla lavorazione della metallizzazione).

Gioia combines aesthetic, technical and functional innovation with a game of transparencies and nuances of colours, to give a touch of personality to the atmosphere. It is presented in the single version or in multiple composition (both with ceiling rose and with decentralization kit) to combine with power cable in transparent PVC or in fabric (available in red, black or military green finishes). It is characterized by a refined oval shape slightly crushed, made of pyrex glass, sandblasted inside. The glass diffusers are available in clear crystal, shaded chrome, polished bronze and polished gold (metallization process).

CORPI DIFFONDENTI / DIFFUSER BODIES



**GII001**

G9 1x48W max



IP20 CE CRI CR BZ OR

da completare con cavo e kit decentramento anche nella versione singola to be completed with power cable and decentralization kit even in the single version

CAVI DI ALIMENTAZIONE IN TESSUTO - PVC / FABRIC - PVC POWER CABLES



PVC TRASPARENTE  
TRANSPARENT PVC

**GII002TR**

cavo cable L.max 1500mm

**GII003TR**

cavo cable L.max 2500mm



TESSUTO ROSSO  
RED FABRIC

**GII002R**

cavo cable L.max 1500mm

**GII003R**

cavo cable L.max 2500mm



TESSUTO VERDE MILITARE  
MILITARY GREEN FABRIC

**GII002V**

cavo cable L.max 1500mm

**GII003V**

cavo cable L.max 2500mm



TESSUTO NERO  
BLACK FABRIC

**GII002N**

cavo cable L.max 1500mm

**GII003N**

cavo cable L.max 2500mm



## KIT DECENTRAMENTO / DECENTRALIZATION KIT

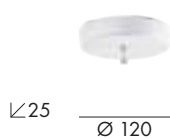

### KITDEC001

KIT decentramento 1 elemento  
1 lamp KIT

B CR



### KITDEC003

KIT decentramento 3 elementi  
3 lamps KIT

B CR

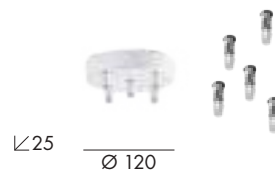

### KITDEC005

KIT decentramento 5 elementi  
5 lamps KIT

B CR

## ROSONI / CEILING ROSES



### MT.ROS003F

Rosone a 3 uscite  
Three-way ceiling rose

B CR



### MT.ROS006F

Rosone a 6 uscite  
Six-way ceiling rose

B CR



cavo rosso / vetro trasparente  
red cable/transparent glass



cavo verde/vetro bronzo  
green cable/bronze glass



cavo rosso/vetro cromo  
red cable/chrome glass



esempio di composizione composition example  
KITDECO03CR + 3 x GII002N + 3 x GII001CR



esempio di composizione composition example  
MT.ROS006FB + 6 x GII002TR + 1 x GII001CR + 3 x GII001CR + 2 x GII001BZ



# MEG

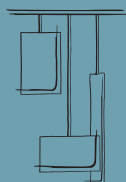

Lampada a sospensione in vetro soffiato con lavorazione baloton. Versione con vetro trasparente in finitura ambra e grigio fumè; versione cromata con interno argento. Disponibile in due dimensioni, la versione piccola viene proposta anche in cadute multiple sia con rosone (a tre e sei feritoie) che con kit decentramento (a tre e cinque elementi). Portalampada in metallo cromato, rosoni disponibili in finitura bianca e cromo, cavo elettrico in PVC trasparente.

Pendant lamp in blown glass in "baloton" style. Clear version in amber and smoky grey finishes; chrome version with silver internal finish. Available in two sizes, the small version is also available with multiple pendants. Both with ceiling rose (with three or six slots) and with free disposal with decentralization kit (for three or five luminaires). Chrome lamp holder, chrome or white ceiling roses, clear PVC power cable.



MADE IN  
MURANO



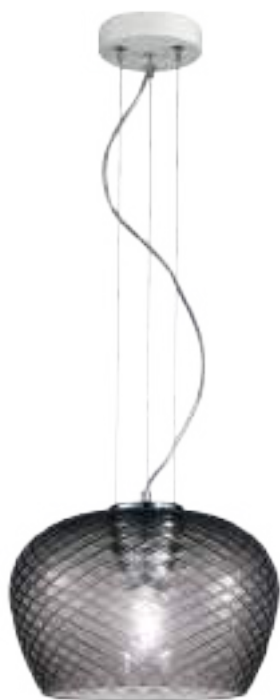

**MEG001**

E27 1x75W max

cavo cable L.max 1200mm

rosone ceiling rose Ø 120x25mm

⊕ ⊖ IP20 CE

FU AM ALU





**MEG005**

G9 1x28W max  
cavo cable L.max 1200mm



⊕ ⊖ IP20 CE

FU AM ALU

da completare con kit decentramento anche nella versione singola to be completed with decentralization kit even in the single version

**KIT DECENTRAMENTO / DECENTRALIZATION KIT**



**KITDEC001**

KIT decentramento 1 elemento  
1 lamp KIT

B CR



**KITDEC003**

KIT decentramento 3 elementi  
3 lamps KIT

B CR



**KITDEC005**

KIT decentramento 5 elementi  
5 lamps KIT

B CR

**ROSONI / CEILING ROSES**



**MT.ROS003F**

Rosone a 3 uscite  
Three-way ceiling rose

B CR



**MT.ROS006F**

Rosone a 6 uscite  
Six-way ceiling rose

B CR







# RIFLESSI



Lampada da terra a luce indiretta con sorgente LED integrata (3000K) realizzata in metacrilato; dimmerabile con variatore. La luce proviene dalla superficie diffondente che copre l'intera altezza della lampada, ideale se rivolta contro una superficie chiara per avere un effetto di luce riflessa. La parte frontale della lampada è in finitura specchiata, che rende l'apparecchio elegante e originale. Apparecchio ideale per la camera da letto, per la zona giorno e il living.

Floor lamp with indirect light emission with integrated LED source (3000K), dimmable with slide control. The light comes from the diffuser covering the entire height of the lamp, ideally facing against a clear surface to have a reflected light effect. The front part is in mirrored finish, making the lamp elegant and original. Ideal for the bedroom and the living area.



**RIF001**

LED 49W

3000K 3210 lm



⊕ ▽ IP20 CE Ⓢ







# CALLA

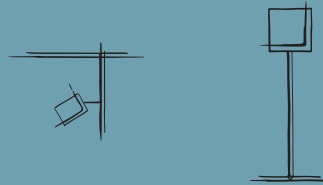

Lampada a parete e da terra con sorgente LED integrata (3000K); dimmerabile con varialuce. La struttura in metacrilato, ottima per la diffusione della luce, avvolge la sorgente luminosa con una forma sinuosa ed elegante che dona un tocco di modernità e ricercatezza ad ogni ambiente.

Wall and floor lamp with integrated LED source (3000K), dimmable with slide control. The methacrylate structure, for diffused light emission, encloses the light source with a sinuous and elegant shape, giving a touch of modernity and sophistication to any room.







**CAA001**

LED 8W  
3000K 540 lm



⊕ ▽ IP20 CE ⚡

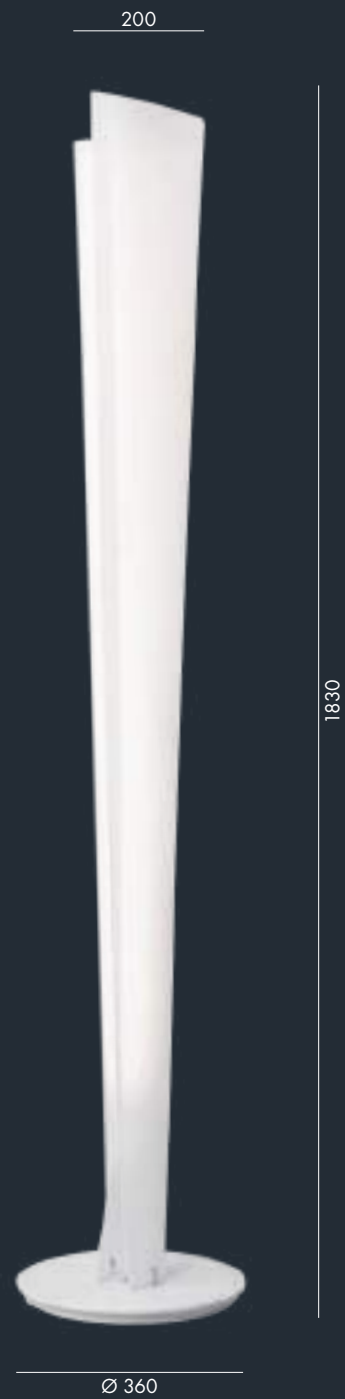

**CAA002**

LED 40W  
3000K 3075 lm



⊕ ▽ IP20 CE ⚡



# CURL

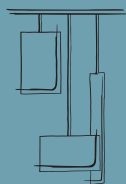

Originale sospensione, dal gusto classico rivisitato in chiave moderna, con bracci ricurvi in metacrilato colorato trasparente, che si fissano sulla struttura centrale cromata lucida. Portalampada con attacco E27 e lampadina a vista, che consente all'utente di montare una lampadina a sua scelta, personalizzando ulteriormente il prodotto. Disponibile nelle finiture trasparenti rosso e ottanio, cavo in pvc trasparente. Rosone cromo lucido.

Unique pendant lamp, with a classic taste revisited in a modern style, with curved arms in transparent coloured methacrylate, fixed on the central polished chrome structure. Wired with E27 lamp holder with visible lamp, that allows the user to mount a light bulb of his choice and further personalize the product. Available in bright transparent red and teal finishes, transparent pvc cable. Polished chrome ceiling rose.



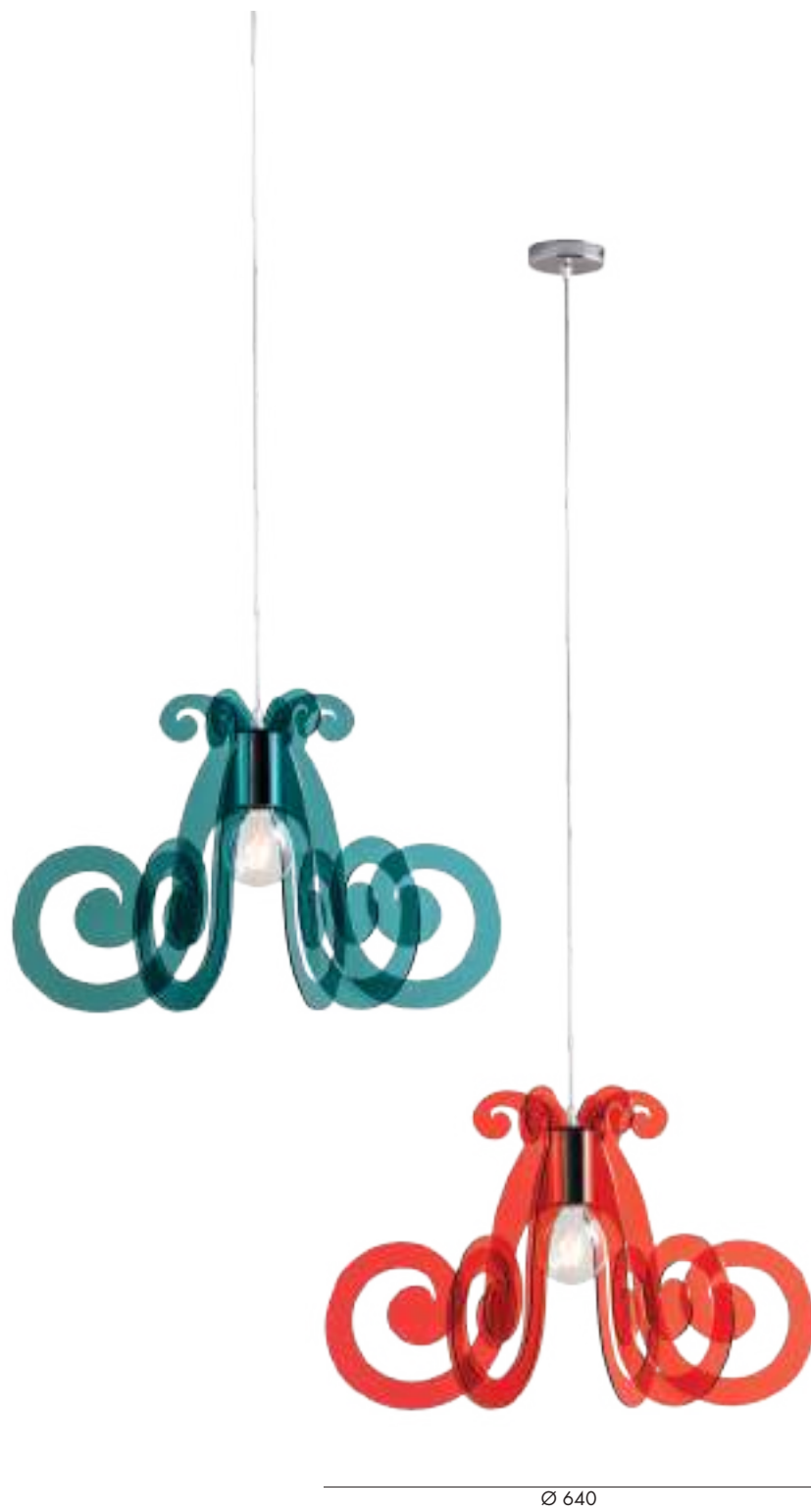

430

Ø 640

**CUR001**

E27 1x75W max

cavo cable L.max 700mm

rosone ceiling rose Ø 100x95 mm



IP20 CE



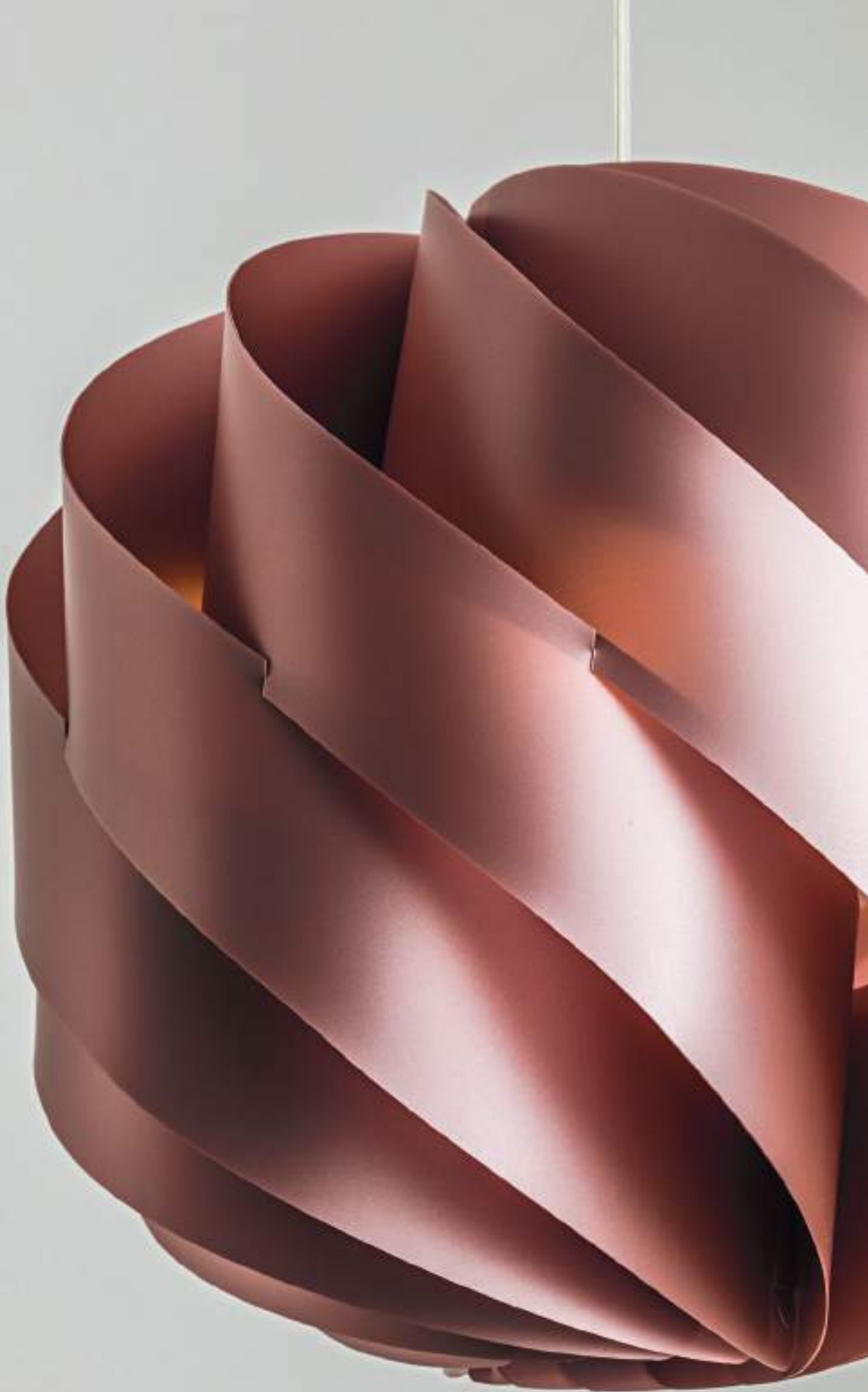

# SHELL

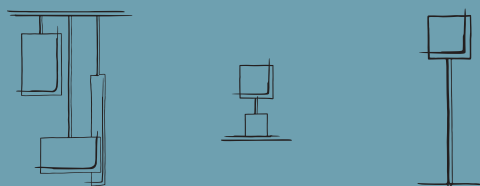

Lampada a sospensione, da tavolo e da terra con diffusore dalle linee sinuose e avvolgenti in policarbonato polilux, per un'omogenea diffusione della luce. Prodotto cablato con portalampada E27 che consente di montare lampadina LED. Disponibile in due finiture (bianco e rosa antico) e due misure per la sospensione. Struttura treppiede della piantana in finitura bianca, cavo della sospensione in pvc trasparente.

Pendant, table and floor lamp with diffuser in sinuous and enveloping polilux polycarbonate lines, for a uniform light diffusion. E27 lamp holder that allows mounting LED lamp. Available in two finishes (white and antique pink) and two sizes for the pendant version. Tripod structure of the floor lamp in white finish, suspension cable in transparent PVC.



MADE IN  
MILANO







**SHE002**

E27 1x60W max - Ø230mm



**SHE001**

E27 1x60W max - Ø400mm



cavo cable L.max 700mm  
rosone ceiling rose Ø100x90mm

IP20 CE

B RO



**SHE003**

E27 1x60W max



IP20 CE

B RO

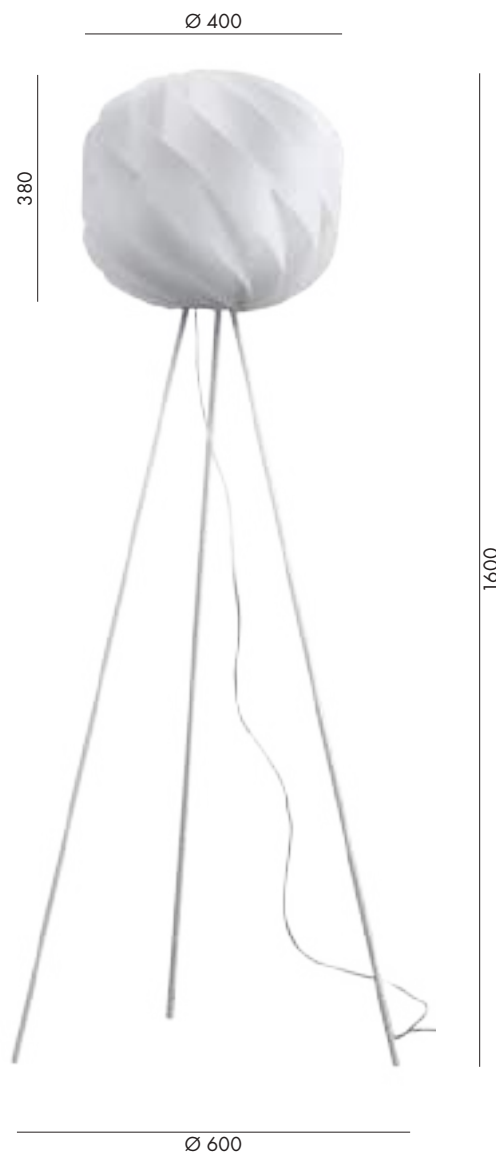

**SHE004**

E27 1x60W max



IP20 CE

B RO

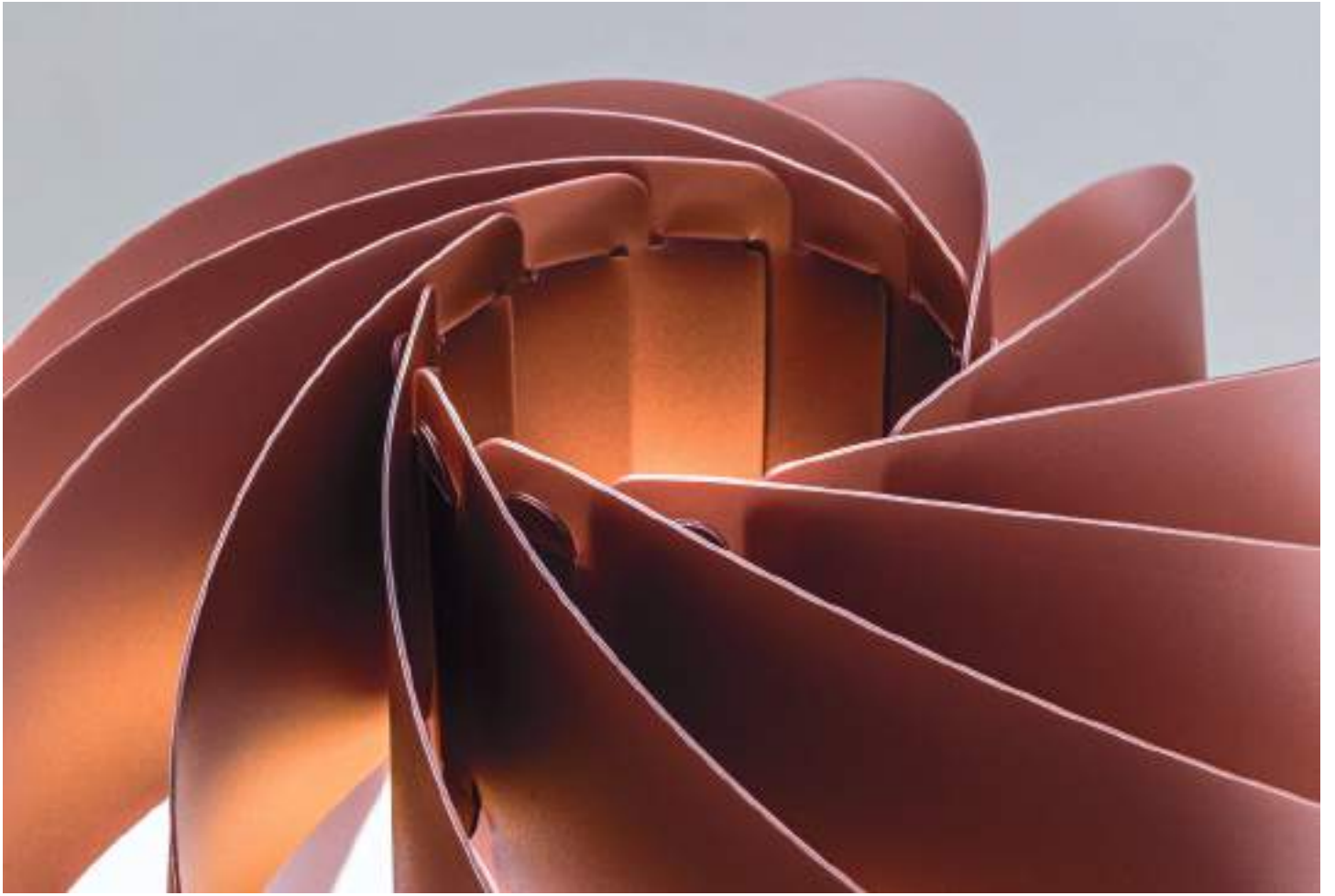





# CARRIE

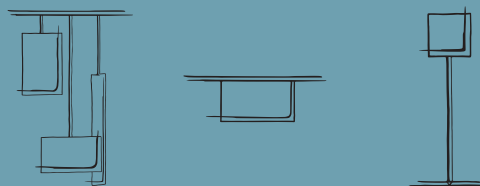

Lampada a sospensione, da terra e da soffitto con diffusore dalle linee morbide ed avvolgenti in policarbonato polilux che aumenta la diffusione della luce. Particolari e finiture cromate. Cablata con attacco E27 che consente di montare lampadina LED.

Pendant, floor and ceiling lamp with polilux polycarbonate diffuser with gentle and enveloping shape with an optimal light diffusion. Chrome details and finishes. E27 lamp holder that allows mounting LED lamp.



MADE IN  
MILANO



MUFFINS:  
- 1 cup butter  
- 1 egg and 1 cup flour  
- 2/3 cup brown sugar  
- 1/2 teaspoon salt  
- 1/3 cup milk

foam  
coffee  
milk



**CAR001**

E27 2x75W max

cavo cable L.max 700mm

rosone ceiling rose Ø100x30mm



⊕ ▽ IP20 CE



**CAR002**

E27 1x75W max

⊕ ▽ IP20 CE



**CAR003**

E27 2x75W max

⊕ ▽ IP20 CE





# DRAW

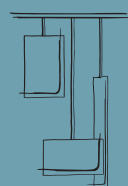

Lampada a sospensione, da tavolo e da terra in policarbonato polilux bianco, materiale che consente un'ottima diffusione della luce. La versione da terra ha due fonti luminose; cablata con attacco E27 che consente di montare lampadina LED.

Table, floor and pendant lamp in white polilux polycarbonate, perfect for diffused light emission. Floor version equipped with two light sources; E27 lamp holder that allows mounting LED lamp.



MADE IN MILANO





390

Ø 400

**3218**

E27 1x75W max

cavo cable L.max 700mm

rosone ceiling rose Ø120x60mm

IP20 CE



320

Ø 190

**P.3218-20**

E27 1x75W max

IP20 CE



470

Ø 260

**P.3218-30**

E27 1x75W max

IP20 CE



1230

Ø 350

**T.3218**

E27 2x75W max

IP20 CE





Corsa al Def con un de

15%

Alcune foto con  
del mondo a tre  
Tela riciclata L1 e

# BELL

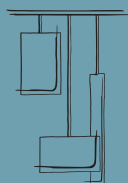

Lampada a sospensione con diffusore in metallo (disponibile in finitura nera opaca e verde salvia) e anello passacavo rivestito in legno, che dona un tocco di personalità e originalità al prodotto. Disponibile in due misure e due colorazioni, con interno del diffusore bianco, per un'ottima diffusione della luce; rosone in tinta col corpo lampada. Prodotto cablato con attacco E27, che consente di montare lampadina LED.

Pendant lamp with metal diffuser (available in matt black and sage green finish) and wood covered fairlead ring giving a touch of personality and originality. Available in two sizes and two colours, with white diffuser inside, for an excellent light diffusion; ceiling rose matching to the lamp body. E27 lamp holder that allows mounting LED lamp.





**BELO01**

E27 1x40W max

cavo cable L.max 2000mm

rosone ceiling rose Ø100x50mm

⊕ IP20 CE



**BELO02**

E27 1x40W max

cavo cable L.max 2000mm

rosone ceiling rose Ø100x50mm

⊕ IP20 CE





## ZIG ZAG

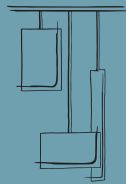

Lampada a sospensione composta da una struttura vuota proposta in due forme con relative altezze; portalampada E27 con lampadina a vista che consente di montare una lampadina LED personalizzando ulteriormente il prodotto. Rosone, portalampada e struttura in metallo verniciato nero, avvolta e decorata da un cavo in tessuto colorato, proposto in tre finiture (rosso, azzurro e giallo), con cavo elettrico in tinta.

Pendant lamp composed by an empty structure available in two shapes and related heights. E27 lamp holder with visible lamp, that allows the user to mount a light bulb of his choice and further personalize the product. Ceiling rose, structure and lamp holder in black painted metal, decorated with a coloured fabric cable, available in three finishes (red, light blue and yellow), matching to the electric cable.



**ZIG001**

E27 1x40W max

cavo cable L.max 1000 mm

rosone ceiling rose Ø 100x25 mm



⊕ ⊖ IP20 CE

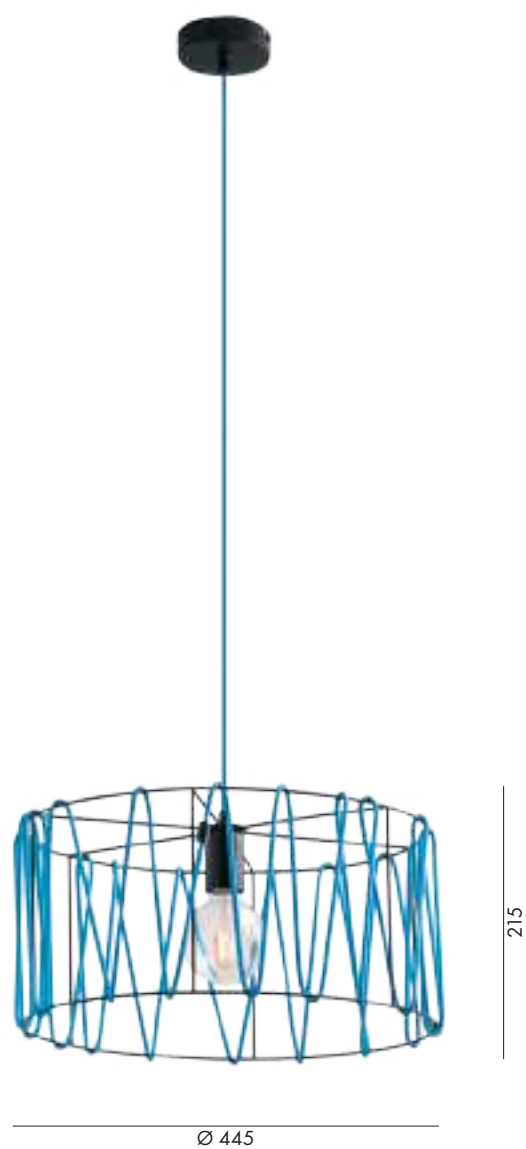

**ZIG002**

E27 1x40W max

cavo cable L.max 1000 mm

rosone ceiling rose XØ 100x25 mm



⊕ ⊖ IP20 CE



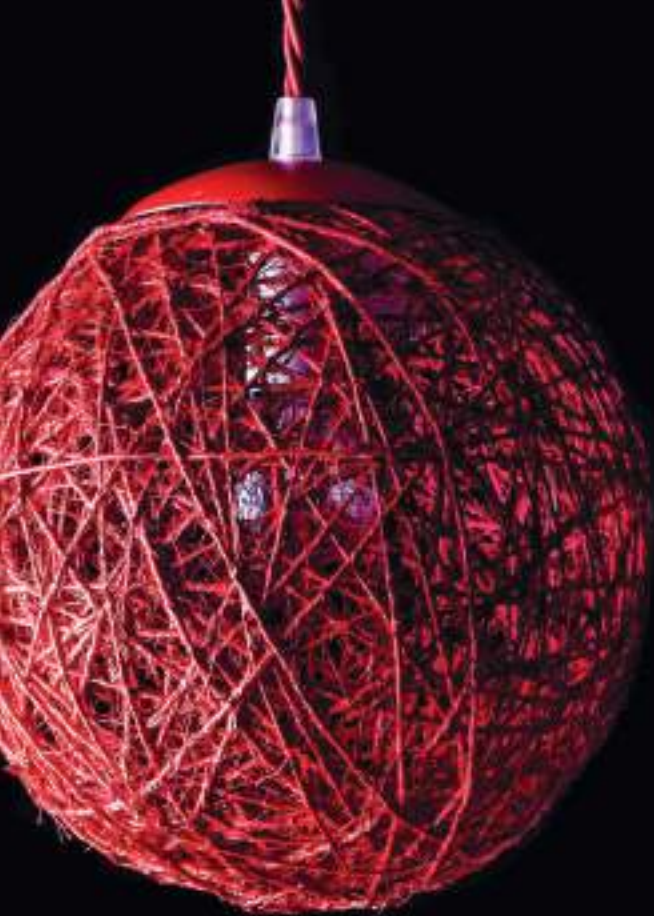



# SANCHO



Lampada a sospensione e da tavolo dalla forma sferica in corda naturale colorata realizzata a mano, con struttura e rosone in metallo cromato. Disponibile in quattro finiture (giallo, rosso, bianco e blu); sospensione proposta in due misure, con rosone singolo o per caduta con tre elementi.

Pendant and table lamp of spherical shape, in hand-made natural coloured cord; chrome metal structure and ceiling rose. Available in four finishes (yellow, red, white and blue); pendant version available in two sizes, in single version or with ceiling rose for three luminaires.

**CORPI DIFFONDENTI / DIFFUSERS**

**SAN001**

E27 1x75W max  
cavo cable L.max 800mm



⊕ ⊖ IP20 CE B R G BLU



**SAN002**

E27 1x75W max  
cavo cable L.max 800mm



⊕ ⊖ IP20 CE B R G BLU



da completare con rosone anche nella versione singola to be completed with ceiling rose even in the single version

**ROSONI / CEILING ROSES**

**SAN003**

Rosone a 1 uscita  
One-way ceiling rose



**SAN004**

Rosone a 3 uscite  
Three-way ceiling rose



**ESEMPIO DI COMPOSIZIONE / COMPOSITION EXAMPLE**



**SAN003 + SAN001G**



**SAN003 + SAN002B**



**SAN004 + SAN001R  
+ SAN001BLU  
+ SAN001G**



**SAN004 + SAN002R  
+ SAN002B  
+ SAN002BLU**

**SAN005**

E27 1x75W max



IP20 CE B R G BLU



Personalizzabile nella finitura colore della corda che compone il diffusore.  
Colour finish of the cord composing the diffuser available upon request.





# TURATI

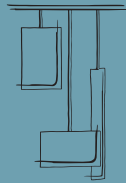

Lampada a sospensione, composta da una struttura in metallo cromata su cui vengono fissate e accostate delle lastre in vetro, in finitura foglia oro. Le lastre racchiudono la fonte luminosa (attacco E27 che consente di montare lampadina LED) con un effetto estremamente decorativo. Proposta in due diametri, con vetro diffondente inferiore per ampliare ulteriormente il fascio luminoso.

Pendant lamp composed by a chrome metal structure on which glass plates in gold leaf finish are secured and joined together. The plates enclose the E27 lamp holder (on which a LED lamp can be mounted), with an extremely decorative effect. Available in two sizes, with lower glass diffuser for a diffused light emission.



470 / 740



Ø 530 / 800

**TUR001ORO**

E27 3x75W max - Ø 530 mm



**TUR002ORO**

E27 5x75W max - Ø 800 mm



cavo cable L.max 800mm

rosone ceiling rose Ø 160x60mm

⊕ ⊖ IP20 CE





# OFU

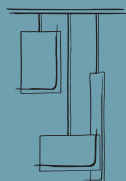

Lampada a sospensione semisfera in metallo verniciato disponibile nei colori bianco (con interno bianco) e nero (con interno bianco o oro). Particolari e rosone in tinta con il diffusore, cavo della sospensione in PVC trasparente. Cablata con attacco E27 che consente di montare lampadina LED.

Pendant lamp with dome shape in painted metal available in white colour (white internal finish) or black colour (white or gold internal finish). Details and ceiling rose in the same colour of the lamp body, PVC clear power cable. E27 lamp holder that allows mounting LED lamp.





250



Ø 500

**OFU001**

E27 1x75W max

cavo cable L.max 1200mm

rosone ceiling rose Ø 100x50mm

⊕ ⊖ IP20 CE

B NOS N





# ERIN

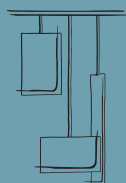

Lampada a sospensione a mezza-sfera di grandi dimensioni in vetro curvato su cui si poggia la struttura in alluminio, disponibile in finitura bianca o nera. Grazie alla duplice finitura dell'oggetto si ottiene una biemissione di luce. Montatura e dettagli cromati. Cablata con attacco E27 che consente di montare lampadina LED.

Large size semi-spherical pendant lamp in bent glass on which an aluminium structure is mounted. Available in white or black finish, due to the double material of the lamp indirect light emission is also possible. Chrome frame and details. E27 lamp holder that allows mounting LED lamp.

**ERIO01**

E27 1x75W max

cavo cable L.max 1200mm

rosone ceiling rose Ø130x30mm

⊕ ⊖ IP20 CE



320



Ø 600





# PICOLIT

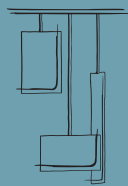

Lampada a sospensione con diffusore in metallo pressato, portalampada E27 che permette di montare lampadina LED. Disponibile nei colori bianco opaco e nero opaco, con interno, portalampada e rosone in tinta. Cavo in PVC trasparente.

Pendant luminaire with metal diffuser, E27 lamp holder that allows mounting LED lamp. Available in white and black finish, with lamp's interior, lamp holder and ceiling rose in the same colour. Clear PVC cable.



**PIC001**

E27 1x75W max

cavo cable L.max 1200mm

rosone ceiling rose Ø75x50mm



  IP20 

 



230 / 260

Ø 400 / 500

# ISAKO

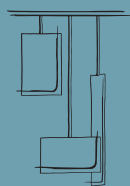

Lampada a sospensione a semi-sfera in vetro bianco satinato per un'ottima diffusione della luce con montatura e rosone in metallo cromato. Disponibile in due dimensioni.

Semi-spherical pendant lamp in satin white glass for a perfect light diffusion with chrome metal frame and ceiling rose. Available in two sizes.

**10801-40**   
E27 1x75W max - Ø 400 mm

**10801-50**   
E27 1x75W max - Ø 500 mm

cavo cable L.max 1200mm  
rosone ceiling rose Ø 130x30mm

  **IP20 CE**



**MADE IN MILANO**



compatibile con lampadine LED con tecnologia smart (pag. 730)  
suitable for smart LED light bulbs (pag. 730)





430



Ø 640

# IPANEMA

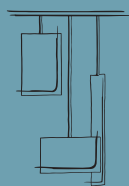

Lampada a sospensione dalla forma sferica leggermente schiacciata; struttura in fili di metallo elettrosaldati tra loro. Disponibile nei colori bianco opaco e nero opaco. Particolari e cavo elettrico, rivestito in tessuto, in tinta con il corpo lampada. Cablata con attacco E27 che consente di montare lampadina LED.

Pendant lamp with a cage structure composed of metal wires, available in matt white and matt black colours. Details and wiring cable, covered in fabric, in the same colour of the lamp body. E27 lamp holder that allows mounting LED lamp.

## IPA001

E27 1x75W max

cavo cable L.max 1200mm

rosone ceiling rose Ø75x50mm

⊕ ⊖ IP20 CE

B N



MADE IN  
MILANO

lampadina LED consigliata: L.284-10-1 (pag. 728)  
recommended LED bulb: L.284-10-1 (pag. 728)



# PEGGY

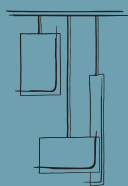

Lampada a sospensione semi-sfera in metacrilato, disponibile in quattro finiture: rosso trasparente, bianco satinato, bianco lucido e grigio fumè. Rosone in tinta, portalampada cromato. Attacco E27 che consente di montare lampadina LED.

Pendant lamp in methacrylate with semi-spherical shape, available in four finishes: clear red, polished white, opal white and smoked grey. Ceiling rose in the same colour and chrome E27 lamp holder that allows mounting LED lamp.



MADE IN  
MILANO



245

Ø 470

**PEG001**



E27 1x75W max

cavo cable L.max 1200mm

rosone ceiling rose Ø 160x70mm

⊕ ⊖ IP20 CE R B SAT FU



# AUDREY

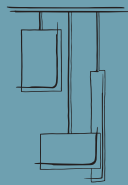

Elegante lampada a sospensione con sorgente LED integrata (3000K), struttura in metallo verniciato (in finitura bianca o nera) e sinuoso diffusore in metacrilato bianco che consente un'ottima diffusione della luce.

Elegant LED pendant lamp (3000K), painted metal structure (white or black finish), sinuous white methacrylate diffuser for a perfect homogeneous light diffusion.

**AUD001**

LED 30W

3000K 2700 lm

cavo cable L.max 1000mm

rosone ceiling rose Ø200x45mm



⊕ ⊖ IP20 CE





# CORVINA

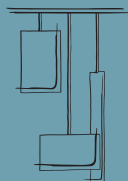

Sospensione a 1, 3 o 5 luci con struttura a forma di cono realizzata in metallo laccato nei colori bianco opaco e nero opaco. Particolari e cavo elettrico, rivestito in tessuto, in tinta con il corpo lampada. Proposta nella versione singola e con kit decentramento a tre o cinque elementi. Portalampada GU10 che consente di montare lampadina LED.

Pendant lamp with cone-shaped structure made in lacquered metal in matt white and matt black colours. Details in the same colour of the lamp body as the wiring cable covered in fabric. Available in single version or with decentralization kit for three or five elements. GU10 lamp holder that allows mounting LED lamp.





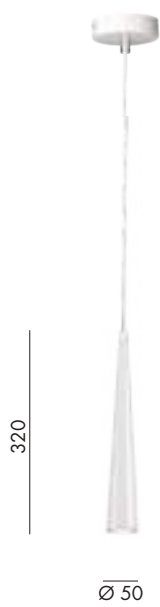

**COR001**

GU10 1x35W max  
 cavo cable L.max 1200mm  
 rosone ceiling rose Ø 85x25mm

⊕ ⊖ IP20 CE



**COR002**

GU10 3x35W max  
 cavo cable L.max 1200mm  
 rosone ceiling rose Ø 120x50mm

⊕ ⊖ IP20 CE



**COR003**

GU10 5x35W max  
 cavo cable L.max 1200mm  
 rosone ceiling rose Ø 120x50mm

⊕ ⊖ IP20 CE





# PARAISO



Lampada a sospensione e a soffitto, struttura composta da riccioli di metallo laccati bianco opaco, con spennellature artigianali realizzate a mano con la tecnica fiorentina, proposte nella versione oro e argento. Decorazioni che movimentano il prodotto, esaltate dagli effetti di luce. Prodotto cablato con portalampada E14 per alloggiare lampadina LED.

Pendant and ceiling lamp, structure consisting of curled elements in matt white lacquered metal, with handmade strokes made with the florentine technique, available in gold and silver version. Decors that confer flow to the luminaire, enhanced by the light effects. E14 lamp holder for LED lamp.



Ø 530

**PAR001**



E14 6x40W max

cavo cable L.max 1200mm

rosone ceiling rose Ø100x60mm

⊕ ⊖ IP20 CE

OR

ARG



Ø 570

250

**PAR002**



E14 3x40W max

⊕ ⊖ IP20 CE

OR

ARG



Ø 600

260

**PAR003**



E14 5x40W max

⊕ ⊖ IP20 CE

OR

ARG



# FLY

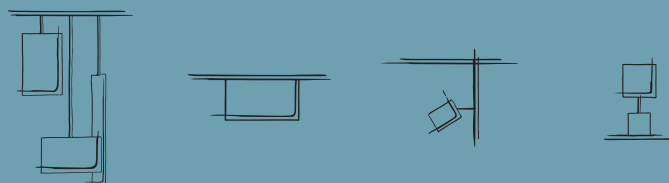

Lampada a sospensione, soffitto, da parete e da tavolo con struttura a forma di ricciolo in metallo, proposta nelle finiture oro satinato e nero. Diffusori a forma sferica in finitura bianco satinato per la struttura oro, fumè per la struttura nera. Cablata con attacco G9 che consente di montare lampadina a LED.

Pendant, ceiling, wall and table lamp with curvy metal structure available in satin gold and black finishes. Round glass diffusers in satin white for the gold version, in smoky grey for the black version. G9 lamp holder that allows mounting LED lamp.





Ø 540

**FLY001**

G9 6x33W

cavo cable L.max 800mm

rosone ceiling rose Ø 100x80mm

⊕ ⊖ IP20 CE

**N** **OS**



Ø 500

∟270

**FLY004**

G9 3x33W

rosone ceiling rose Ø 140x100mm

⊕ ⊖ IP20 CE

**N** **OS**



Ø 600

∟270

**FLY003**

G9 5x33W

rosone ceiling rose Ø 140x100mm

⊕ ⊖ IP20 CE

**N** **OS**



Ø 850

∟300

**FLY002**

G9 9x33W

rosone ceiling rose Ø 140x100mm

⊕ ⊖ IP20 CE

**N** **OS**







**FLY005**

G9 3x33W

attacco a parete wall support Ø110x60mm

⊕ ⊖ IP20 CE

N OS



**FLY006**

G9 2x33W

attacco a parete wall support Ø80x60mm

⊕ ⊖ IP20 CE

N OS

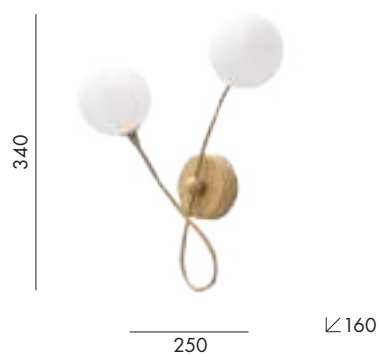

**FLY007**

G9 1x33W

⊕ ⊖ IP20 CE

N OS



Personalizzabile nella colorazione della struttura in alluminio.  
Colour of the aluminium body available upon request.

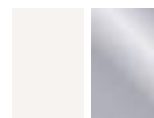

B CR



# BESANA

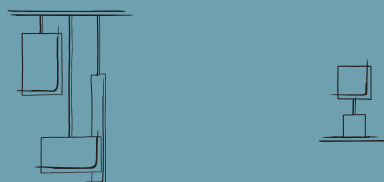

Besana fonde l'artigianalità con un gusto più tecnico: il vetro sfumato realizzato a mano è impreziosito da una calotta metallica, dal tocco contemporaneo. Besana è disponibile nella versione da tavolo e a sospensione in due misure con attacco E27 che consente di montare lampadina LED. La versione grande esalta ulteriormente la bellezza e l'importanza della sfera di cristallo pieno e il gioco di trasparenze e opacità del vetro soffiato a mano nella lavorazione artigianale della sfumatura. Un prodotto elegante e raffinato anche da spento.

Besana blends craftsmanship and a more technical taste: the hand-blown glass is enhanced by a contemporary metal cap. Besana is available in the table and in the pendant version in two sizes with E27 lamp holder that allows mounting LED lamp. The bigger version enhances the beauty and the importance of the full crystal sphere and the game of transparency and opacity of the blown glass, obtained with the artisan technique of gradation. An elegant and sophisticated product even when turned off.



MADE IN  
MURANO

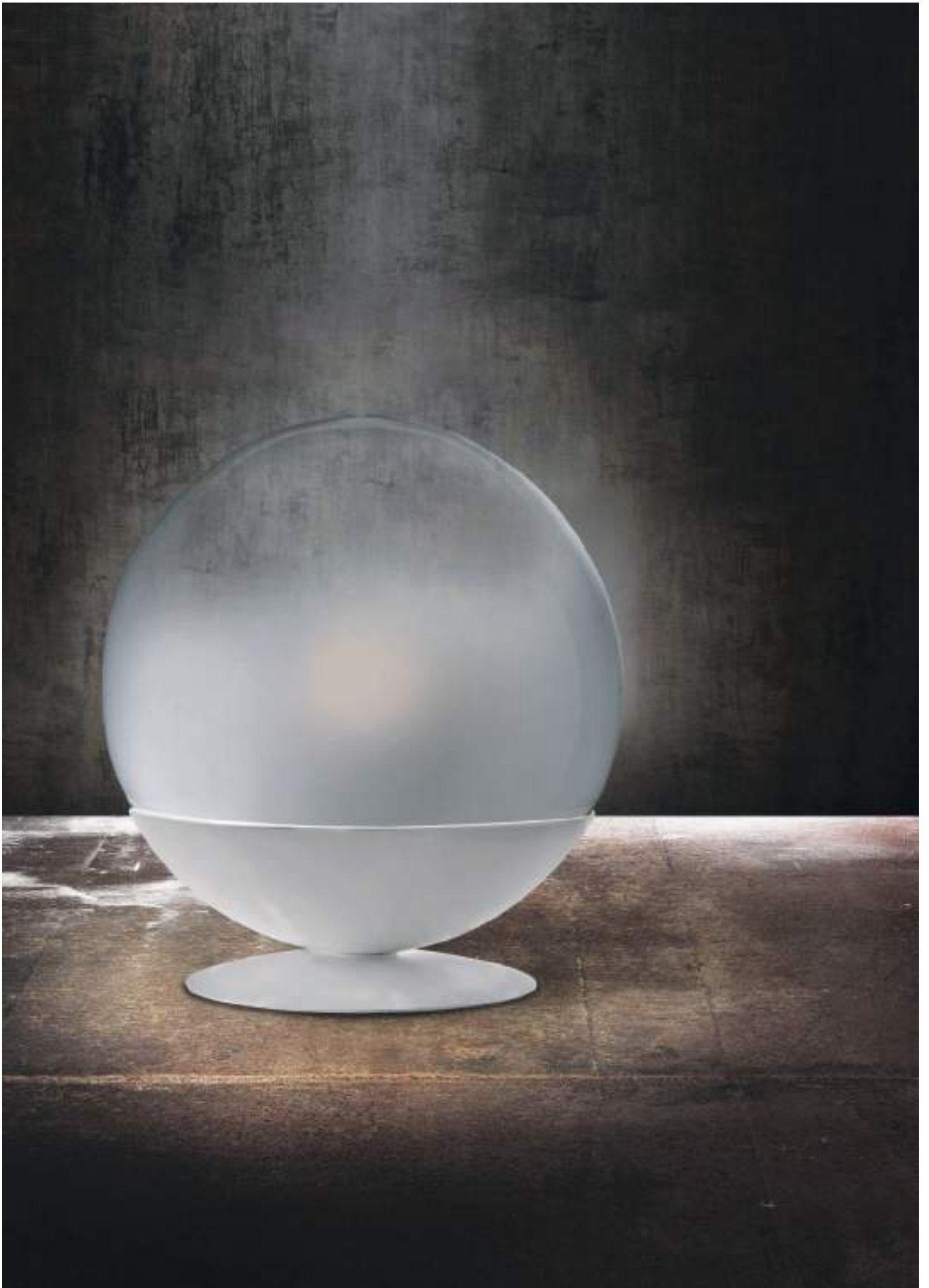

400 / 500



Ø 350 / 450

**BES004**

E27 1x42W max - Ø 350 mm  
base base Ø 250 mm



**BES003**

E27 3x42W max - Ø 450 mm  
base base Ø 300 mm



IP20 CE



Ø 350 / 450

**BES002**

E27 1x42W max - Ø 350 mm



**BES001**

E27 3x42W max - Ø 450 mm



cavo cable L.max 1000mm  
rosone ceiling rose Ø 140x35mm

IP20 CE

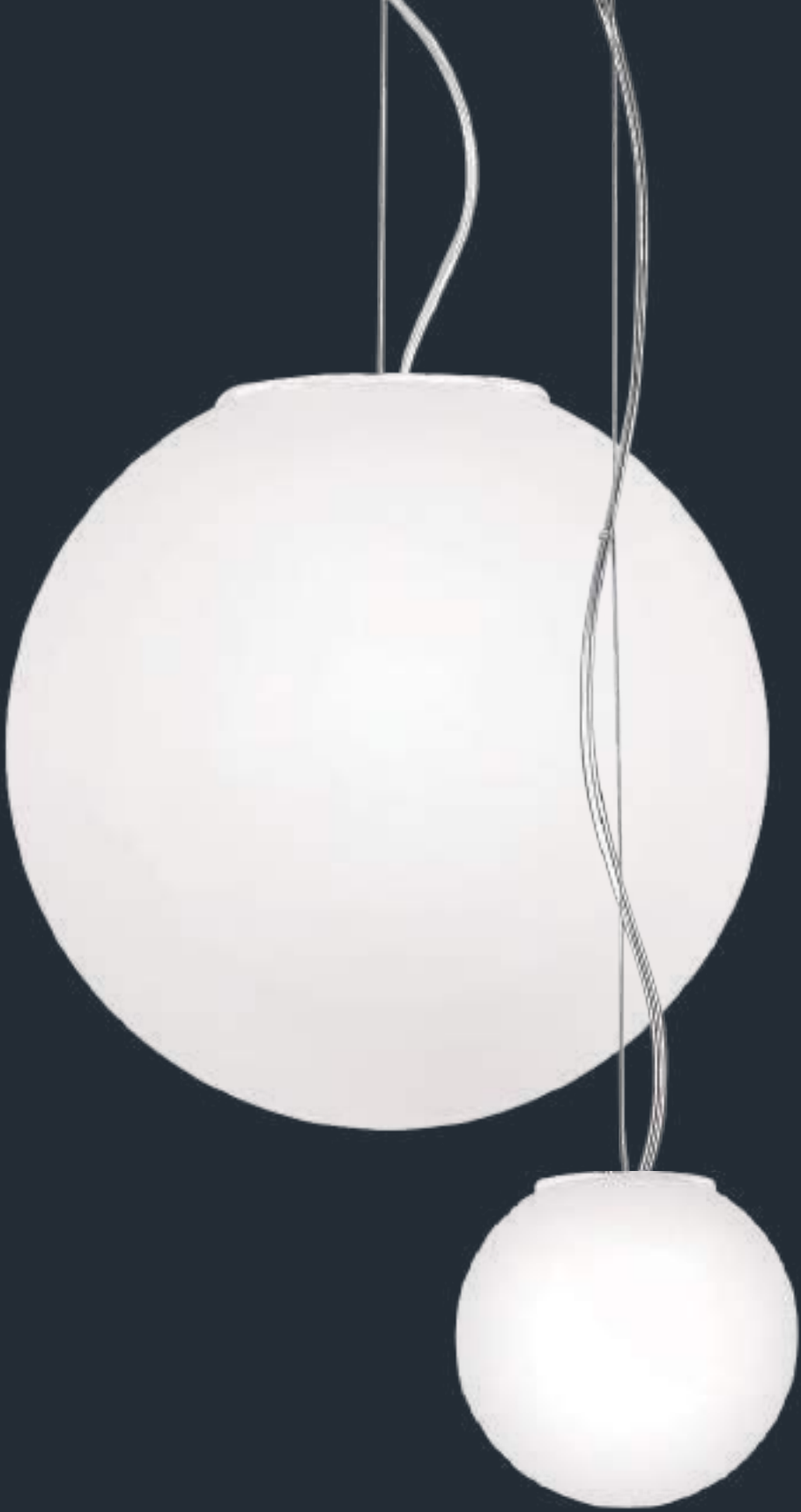

# EMILY

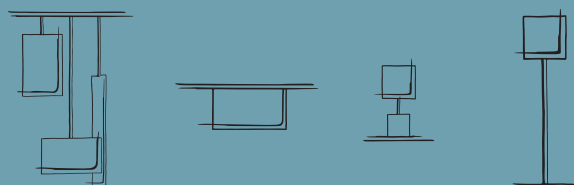

Lampada a sospensione, da soffitto, da tavolo e da terra con diffusore tondo in vetro soffiato satinato, per un'ottima diffusione della luce. Disponibile in diversi diametri, nella versione sospesa proposta in versione singola (con rosone bianco) o in caduta multipla a tre elementi con kit decentramento in finitura cromo (solo per le dimensioni mini e small). Plafoniera a grappolo a cinque elementi (struttura bianca).

Pendant, ceiling, table and floor lamp with round satin blown glass diffuser, for a diffused light emission. Available in different sizes, in the pendant version as single element (white ceiling rose) or in multiple three elements composition with decentralization kit (only for mini and small versions). Ceiling luminaire composed by five elements (white structure).



MADE IN  
MILANO





**5488-16-B**

E14 1x40W max - Ø 160 mm

**5488-20-B**

E27 1x75W max - Ø 200 mm

**5488-30-B**

E27 1x75W max - Ø 300 mm

**5488-40-B-LED**

LED 17W - Ø 400 mm

2700K 1600 lm

**5488-40-B**

E27 1x75W max - Ø 400 mm

cavo cable L.max 1200mm  
rosone ceiling rose Ø100x30mm IP20 **CE**

150 / 190 / 290 / 390

Ø 160 / 200 / 300 / 400

**EM1001**

E14 3x40W max

cavo cable L.max 1200mm  
rosone ceiling rose Ø100x30mm IP20 **CE**

150

Ø 160

**EM1002**

E27 3x75W max

cavo cable L.max 1200mm  
rosone ceiling rose Ø100x30mm IP20 **CE**

190

Ø 200



**5487-16-B**E14 5x40W max - Ø vetro glass 160 mm  
dim. tot. Ø 400**5487-20-B**E27 5x75W max - Ø vetro glass 200 mm  
dim. tot. Ø 500**5487-30-B**E27 5x75W max - Ø vetro glass 300 mm  
dim. tot. Ø 700**5487-40-B**E27 5x75W max - Ø vetro glass 400 mm  
dim. tot. Ø 900

⊕ ⊖ IP20 CE



380 / 450 / 650 / 850

Ø 400 / 500 / 700 / 900

**EMI004**

E27 1x75W max - Ø 300 mm

**EMI006**LED 17W - Ø 400 mm  
2700K 1600 lm**EMI005**

E27 1x75W max - Ø 400 mm



⊕ ⊖ IP20 CE



290 / 390

Ø300/400



**P.5488-16-B**

E14 1x40W max - Ø 160 mm



**P.5488-20-B**

E27 1x75W max - Ø 200 mm



**P.5488-30-B**

E27 1x75W max - Ø 300 mm



**P.5488-40-B-LED**

LED 17W - Ø 400 mm

2700K 1600 lm



**P.5488-40-B**

E27 1x75W max - Ø 400 mm



IP20



150 / 190 / 290 / 390

Ø 160/200/300/400

**EMI003**

E27 1x75W max



IP20

Ø 350



1850



# MARILYN

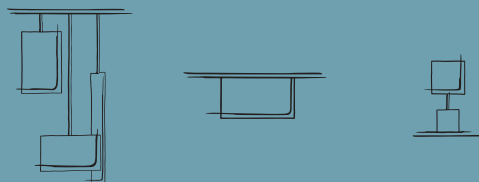

Lampada a sospensione, da tavolo e a soffitto con diffusore in vetro soffiato bianco satinato lavorato a mano. La struttura interna, visibile dai fori della lampada, è tornita a mano in metallo cromato. Cablata con attacco tradizionale (G9 o E27) che consentono di montare lampadina LED.

Pendant, ceiling and table lamp with diffuser in hand-bevelled satin white blown glass. The internal structure, visible from the lamp's holes, is hand-turned in chrome metal. G9 or E27 lamp holder that allows mounting LED lamp.



MADE IN  
MURANO





**S.10455-35**

E27 1x75W max - Ø 360 mm



**S.10455-50**

E27 1x75W max - Ø 480 mm



cavo cable L.max 1200mm  
rosone ceiling rose Ø 120x30mm

⊕ ▽ IP20 CE



270 / 360

Ø 360 / 480

**10455-35**

E27 1x75W max - Ø 360 mm



**10455-50**

E27 1x75W max - Ø 480 mm



⊕ ▽ IP20 CE



280 / 380

Ø 360 / 480

**P.10455-20**

G9 1x33W max - Ø 200 mm



**P.10455-35**

E27 1x75W max - Ø 360 mm



⊕ ▽ IP20 CE



170 / 270

Ø 200 / 360



# KATHY

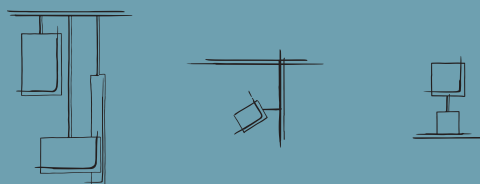

Lampada a sospensione, da parete e da tavolo in vetro soffiato bianco satinato. Struttura e particolari in metallo cromato. Cablata con attacco E27 che consente di montare lampadina LED.

Pendant, wall and floor lamp in satin white blown glass. Chrome metal structure and details. E27 lamp holder that allows mounting LED lamp.





**10330-25**

E27 1x75W max  
 cavo cable L.max 1200mm  
 rosone ceiling rose Ø130x30mm

⊕ ⊖ IP20 CE



**10330-50**

E27 1x75W max  
 cavo cable L.max 1200mm  
 rosone ceiling rose Ø120x30mm

⊕ ⊖ IP20 CE



**A.10330-20**

E27 1x75W max

⊕ ⊖ IP20 CE



**P.10330-25**

E27 1x75W max

⊕ ⊖ IP20 CE



**P.10330-50**

E27 1x75W max

⊕ ⊖ IP20 CE





# RUNAK

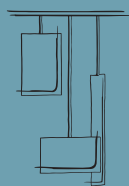

Lampada a sospensione con diffusore a sfera in vetro soffiato lucido, struttura tige e rosone in metallo laccato disponibile nelle finiture bianco, cromo e oro lucido. Attacco E27 che consente di montare lampadina LED.

Pendant lamp with spheric diffuser in polished blown glass; structure stem and ceiling rose in lacquered metal available in white, chrome and polished gold. E27 lamp holder that allows mounting LED lamp.





Ø 250

**RUN001**

E27 1x75W max  
cavo cable L.max 1000mm  
rosone ceiling rose Ø100x60mm



⊕ ⊖ IP20 CE



Ø 300

**RUN002**

E27 1x75W max  
cavo cable L.max 1000mm  
rosone ceiling rose Ø100x60mm



⊕ ⊖ IP20 CE



Ø 350

**RUN003**

E27 1x75W max  
cavo cable L.max 1000mm  
rosone ceiling rose Ø100x60mm



⊕ ⊖ IP20 CE



Ø 400

**RUN004**

E27 1x75W max  
cavo cable L.max 1000mm  
rosone ceiling rose Ø100x60mm



⊕ ⊖ IP20 CE



compatibile con lampadine LED con tecnologia smart (pag. 730)  
suitable for smart LED light bulbs (pag. 730)



# TASHA

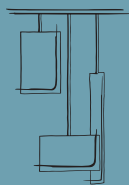

Lampada a sospensione e da tavolo con struttura in metallo cromato e diffusore in vetro soffiato trasparente con all'interno decorazioni in filo di alluminio che arricchiscono il prodotto. Sospensione disponibile in due misure; apparecchio cablato con attacco E27 con lampadina a vista che consente all'utente di montare una lampadina a sua scelta, personalizzando ulteriormente il prodotto.

Table and pendant lamp with structure in chrome metal and diffuser in blown clear glass, with interior decorative aluminium wires that enhance the lamp. Pendant version available in two sizes; E27 lamp holder with visible lamp, that allows the user to mount a light bulb of his choice and further personalize the product.





Ø 300 / 350

**TAS001**

E27 1x75W max - Ø300 mm



**TAS002**

E27 1x75W max - Ø350 mm



cavo cable L.max 1200mm  
rosone ceiling rose Ø130x70mm

⊕ ▽ IP20 CE



Ø 300

340

**TAS003**

E27 1x75W max



⊕ ▽ IP20 CE



# CLAIRE



Lampada a sospensione e da terra in vetro soffiato bianco latte lucido a forma di cupola. Struttura in metallo verniciato bianco opaco per la lampada da terra, struttura in metallo cromato per la sospensione. Sospensione disponibile in tre dimensioni; nella versione piccola proposta in cadute multiple, sia con rosone che con kit decentramento a tre e sei elementi.

Pendant and floor lamp with dome-shaped diffuser made in polished pure white blown glass. White painted metal structure for floor version, chrome metal structure for pendant version. Pendant lamp available in three sizes; small version available in multiple composition, both with ceiling rose and with decentralization kit for three and six luminaires.



MADE IN  
MURANO



**CLA001**

E27 1x75W max  
cavo cable L.max 2000mm



⊕ ⊖ IP20 CE

da completare con kit decentramento anche nella versione singola to be completed with decentralization kit even in the single version

**KIT DECENTRAMENTO / DECENTRALIZATION KIT**



**KITDEC001**

KIT decentramento 1 elemento  
1 lamp KIT

B CR



**KITDEC003**

KIT decentramento 3 elementi  
3 lamps KIT

B CR



**KITDEC005**

KIT decentramento 5 elementi  
5 lamps KIT

B CR

**ROSONI / CEILING ROSES**



**MT.ROS003F**

Rosone a 3 uscite  
Three-way ceiling rose

B CR



**MT.ROS006F**

Rosone a 6 uscite  
Six-way ceiling rose

B CR



esempio di composizione composition example  
KITDEC003B + 3 x CLA001



esempio di composizione composition example  
KITDEC005CR + 5 x CLA001



esempio di composizione composition example  
MT.ROS003FCR + 3 x CLA001



esempio di composizione composition example  
MT.ROS006FB + 6 x CLA001



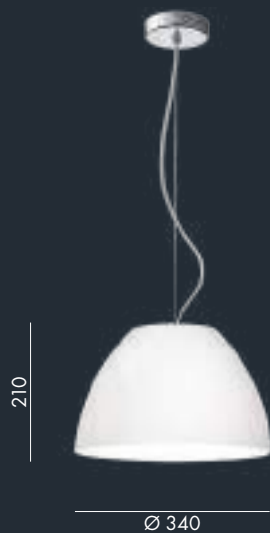

**S.10570-35**

E27 1x75W max

cavo cable L.max 1200mm

rosone ceiling rose Ø120x30mm

⊕ ⊖ IP20 CE

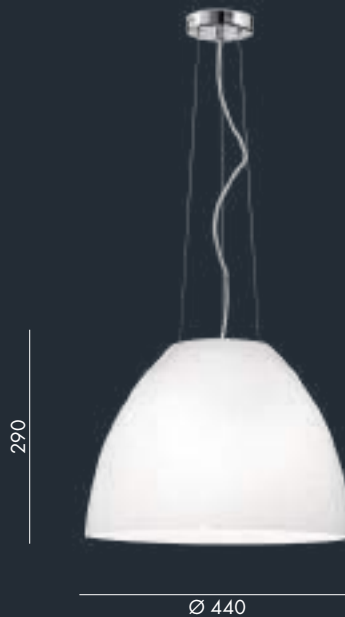

**S.10570-40**

E27 1x75W max

cavo cable L.max 1200mm

rosone ceiling rose Ø120x30mm

⊕ ⊖ IP20 CE

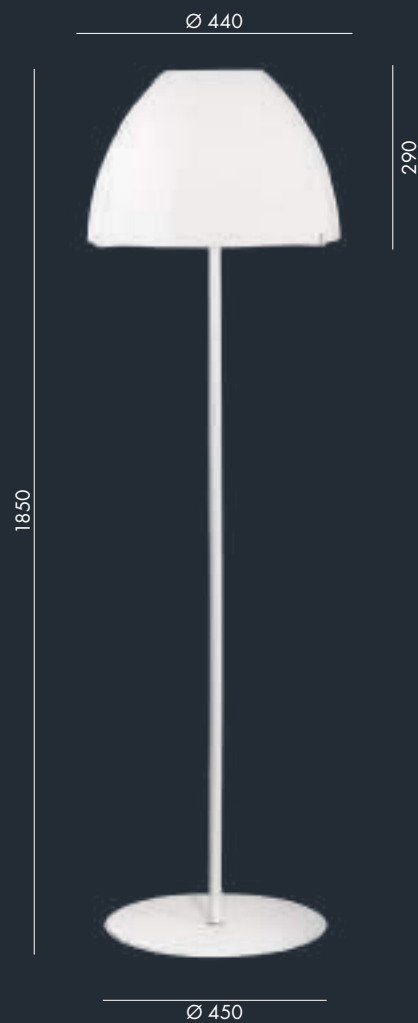

**T.10570**

E27 1x75W max

⊕ ⊖ IP20 CE







# GRETA

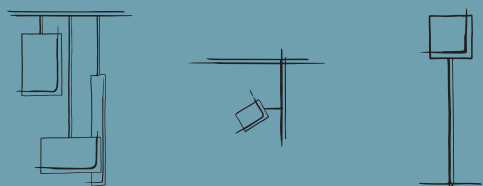

Lampada a sospensione, da parete e da terra; struttura in metallo cromato e diffusore in vetro soffiato opale, dalla particolare forma asimmetrica, con un'ottima diffusione della luce.

Pendant, wall and table lamp; chrome metal structure and opal white blown diffuser, with a particular asymmetrical shape. Excellent light diffusion.





**1404-B**

G9 3x60W max

cavo cable L.max 1200mm

rosone ceiling rose Ø 100x30mm

⊕ ⊖ IP20 CE



**1404-45-B**

E27 3x75W max

cavo cable L.max 1200mm

rosone ceiling rose Ø 110x30mm

⊕ ⊖ IP20 CE



**A.1404-30-SX-B**

R7s117 1x120W max

⊕ ⊖ IP20 CE

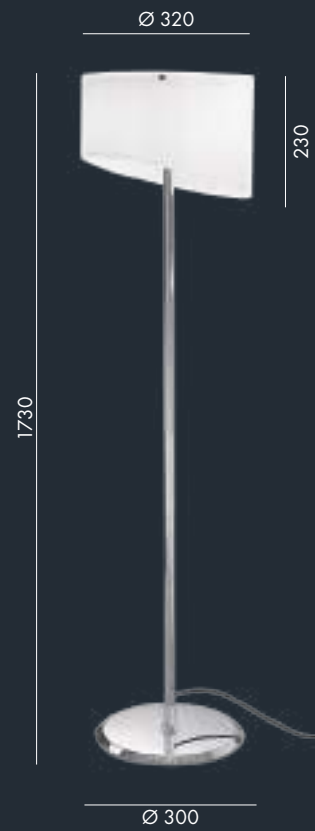

**T.1404-B**

G9 3x60W max

⊕ ⊖ IP20 CE





# GLENN

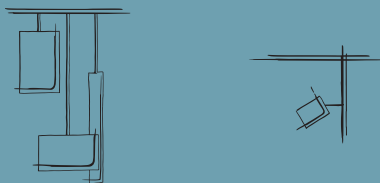

Lampada a sospensione e a parete in vetro soffiato bianco satinato per un'ottima diffusione della luce. La montatura bianca opaca dell'appliche si confonde con la superficie su cui viene montata, a cui rimane molto adesa. Attacco a baionetta che permette una facile manutenzione. Disponibile con LED integrato (2700K) o con attacco E27 che consente di montare lampadina LED.

Pendant and wall lamp in satin white blown glass for optimal light diffusion. The white frame of the wall luminaire blends in with the surface on which it is closely mounted. Bayonet fitting for easy maintenance. Available with integrated LED source (2700K) or with E27 lamp holder that allows mounting LED.



**S.10470-LED**

LED 17W  
2700K 1600 lm



**S.10470**

E27 3x75W max



cavo cable L.max 1200mm  
rosone ceiling rose Ø120x30mm

⊕ ⊖ IP20 CE

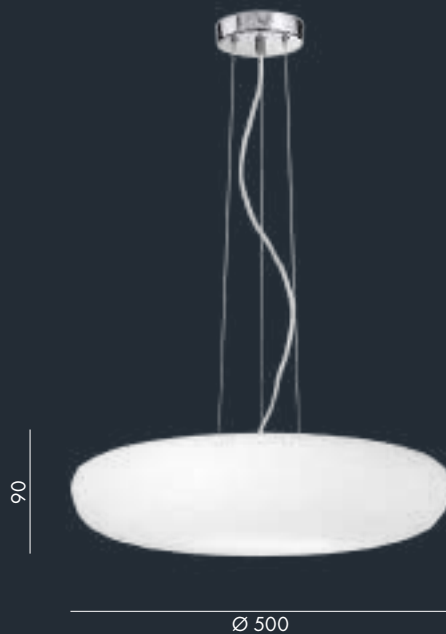

**A.10470-30-LED**

LED 13W  
2700K 1200 lm



**A.10470-30**

E27 1x75W max



⊕ ⊖ IP20 CE

**A.10470-40-LED**

LED 13W  
2700K 1200 lm



**A.10470-40**

E27 2x75W max



⊕ ⊖ IP20 CE





# HOLLY

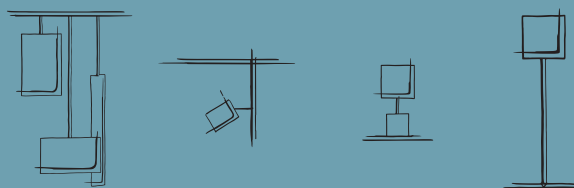

Lampada a sospensione, da parete, da tavolo e da terra in vetro soffiato satinato bianco. Vetro di chiusura inferiore a protezione della fonte luminosa (A.3867-10 chiusura in metallo). Disponibile in diverse misure e relative potenze, con fonte LED integrata (2700K) o con attacco tradizionale (G9 o E27) che consentono di montare lampadina LED.

Pendant, wall, table and floor lamp in satin white blown glass. Lower cover glass to protect the lamp holder (A.3867-10 metal cover). Available in different sizes and related powers with integrated LED source (3000K) or standard lamp holder (G9 or E27) that allows mounting LED lamp.



MADE IN  
MURANO



**3867-30-LED**

LED 20W  
2700K 2000 lm



**3868-30**

E27 2x75W max



cavo cable L.max 1200mm  
rosone ceiling rose Ø 120x30mm

⊕ ⊖ IP20 CE



**3867-45-LED**

LED 27W  
2700K 2500 lm



**3868-45**

E27 3x75W max



cavo cable L.max 1200mm  
rosone ceiling rose Ø 120x30mm

⊕ ⊖ IP20 CE



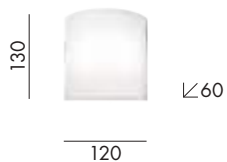

**A.3867-10-LED**

LED 10W  
2700K 1000 lm



**A.3867-10**

G9 1x60W max



⊕ ▽ IP20 CE



**A.3867-20-LED**

LED 13W  
2700K 1200 lm



**A.3867-20**

E27 1x75W max



⊕ ▽ IP20 CE



**A.3867-30-LED**

LED 17W  
2700K 1600 lm



**A.3867-30**

E27 2x75W max



⊕ ▽ IP20 CE



**P.3867**

E27 1x75W max



⊕ ▽ IP20 CE

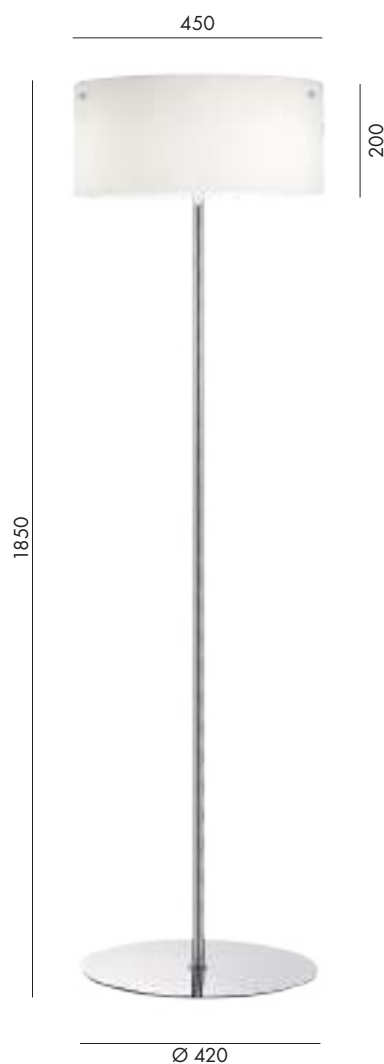

**T.3867**

E27 3x75W max



⊕ ▽ IP20 CE Ⓢ



# GLORIA

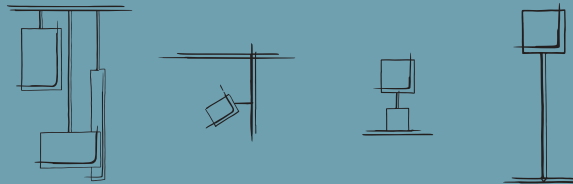

Lampada a sospensione, da parete, da tavolo e da terra in vetro soffiato bianco satinato; triplo strato di vetro. Nella lampada da terra base e fusto in finitura bianca opaca, nella lampada a sospensione particolari e rosone cromati. Cablata con attacco E27 e E14 che consentono di montare lampadina LED.

Pendant, wall, table and floor lamp in satin white blown glass; triple glazed. Floor lamp features white structure, while the pendant lamp is enhanced by chrome finishes. E27 or E14 lamp holders that allow mounting LED lamp.



MADE IN  
MURANO





**10850-20**

E27 1x75W

cavo cable L.max 1200mm  
rosone ceiling rose Ø 130x30mm

⊕ ⊖ IP20 CE



**10850-30**

E27 3x75W

cavo cable L.max 1200mm  
rosone ceiling rose Ø 120x30mm

⊕ ⊖ IP20 CE



**A.10850-20**

E27 1x75W

⊕ ⊖ IP20 CE



**A.10850-30**

E27 2x75W

⊕ ⊖ IP20 CE







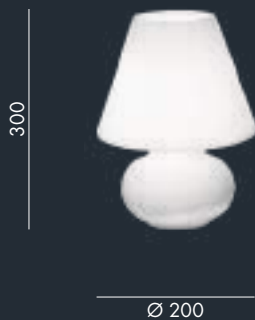

**P.10850-20**  
E14 1x42W



□ ▽ IP20 CE



**P.10850-30**  
E27 1x75W



□ ▽ IP20 CE



**P.10850-40**  
E27 1x75W



□ ▽ IP20 CE

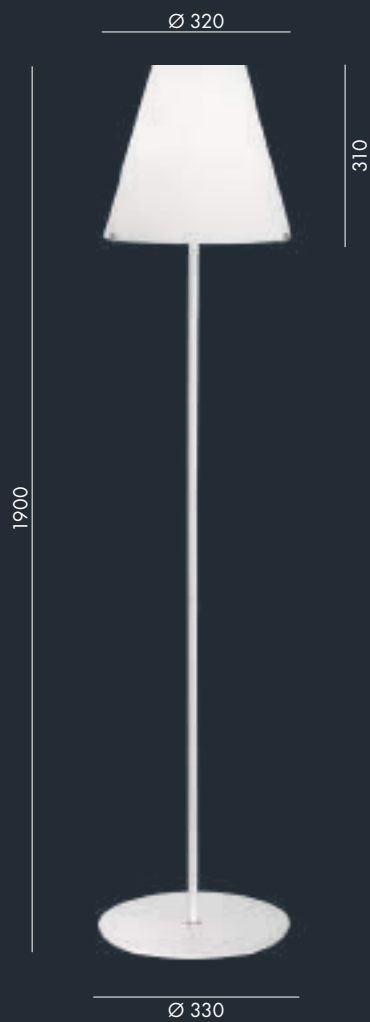

**T.10850**  
E27 1x75W



⊕ ▽ IP20 CE Ⓢ



# JUDY



Lampada da tavolo con struttura in metallo laccato bianco e vetri soffiati satinati; sia la base che il diffusore fungono da elementi diffondenti con accensione separata della parte inferiore e superiore. Proposta in tre misure e relative potenze; le versioni piccola e media hanno due accensioni, la versione grande tre.

Table lamp with white lacquered metal structure and satin blown glasses; both the base and the diffuser are light on and they are available in three sizes and related powers. Small and medium versions have two switches, bigger version three; base and diffuser can be light on separately.



**P.1304-35**

E14 1x40W + E14 1x40W



□ ▽ IP20 CE



**P.1304-55**

E14 1x40W + E27 1x75W



□ ▽ IP20 CE



**P.1304-75**

E27 4x75W + E27 1x75W



□ ▽ IP20 CE



# GRACE

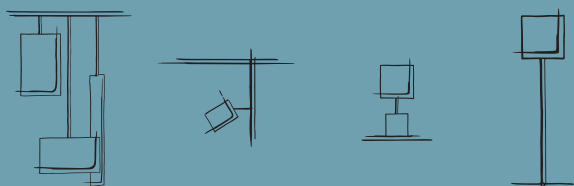

Lampada a sospensione, da parete, da tavolo e da terra con attacco E14 o E27 che consentono di montare lampadina LED. Struttura in metallo verniciato colore alluminio anodizzato, diffusore in vetro soffiato bianco acidato dalla particolare forma a spirale.

Pendant, wall, table and floor lamp with E14 and E27 lamp holders that allow mounting LED lamp. Structure in painted metal in anodized aluminium colour, diffuser in white blown glass, with a particular spiryal shape.





**3865**

E27 1x75W max

cavo cable L.max 1200mm

rosone ceiling rose Ø 130x70mm

⊕ ⊖ IP20 CE

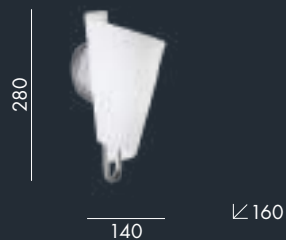

**A.3865**

E14 1x40W max

⊕ ⊖ IP20 CE

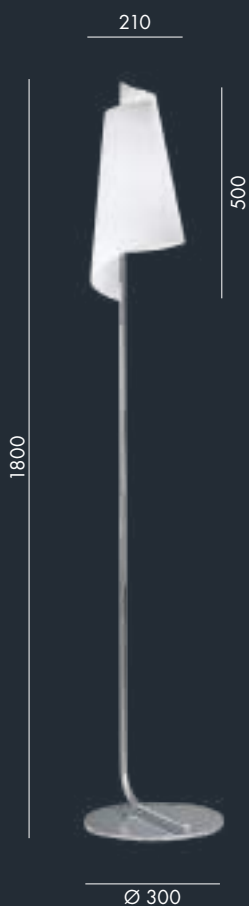

**T.3865**

E27 1x75W

⊕ ⊖ IP20 CE



**A.1075-B**

E27 1x75W max

⊕ ⊖ IP20 CE



**P.3865-40**

E14 1x40W max

⊕ ⊖ IP20 CE







# SOPHIA

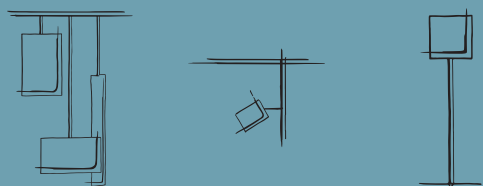

Lampada a sospensione, da parete e da terra, con diffusore in vetro bianco soffiato satinato dalla forma sinuosa. Struttura e particolari in metallo nichelato satinato per la sospensione, fusto in alluminio bianco nella versione da terra. Cablata con attacco E27 che consente di montare lampadina LED.

Pendant, wall and floor lamp with satin white blown glass diffuser with a synuous shape. Nickel-plated metal structure and details for the suspended version, white aluminium shaft in the floor version. E27 lamp holder that allows mounting LED lamp.





**2596-40**

E27 1x75W

cavo cable L.max 1200mm  
rosone ceiling rose Ø 130x30mm

⊕ ⊖ IP20 CE



**2596-20**

E27 1x75W

cavo cable L.max 1200mm  
rosone ceiling rose Ø 130x30mm

⊕ ⊖ IP20 CE



**A.2596-40**

E27 2x75W

⊕ ⊖ IP20 CE

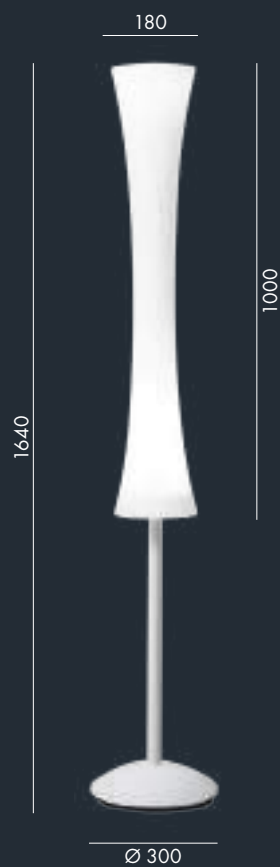

**SOP001**

E27 3x75W max

⊕ ⊖ IP20 CE





# MILETO

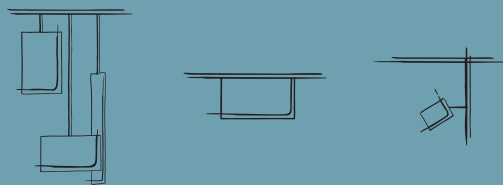

Lampada a sospensione, da parete e a soffitto in vetro curvato bianco satinato. Struttura e particolari cromati. Disponibile con LED integrato (3000K) o con attacco tradizionale (E27) che consente di montare lampadina LED.

Pendant, wall and ceiling lamp in satin white bent glass. Chrome structure and details. Available with integrated LED source (3000K) and with standard lamp holder (E27) that allows mounting LED lamp.



590

210

∟190



300

200

∟70

**MIE009B**

E27 3x75W

cavo cable L.max 1200mm

rosone ceiling rose 350x65x25mm



⊕ ∇ IP20 CE

**MIE008B**

LED 14W

3000K 1300 lm



**MIE004B**

E27 1x75W max



⊕ ∇ IP20 CE

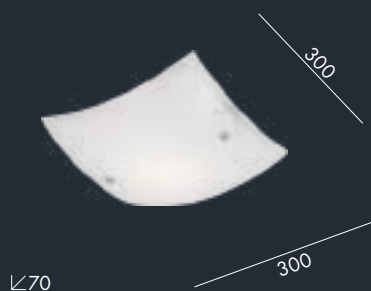

∟70

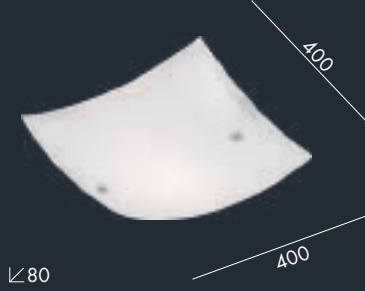

∟80

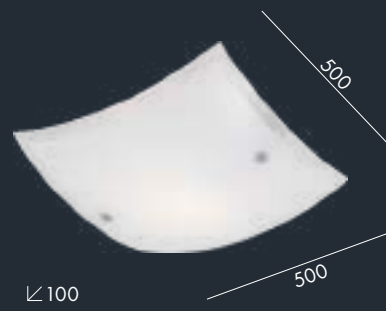

∟100

**MIE005B**

LED 12W

3000K 1200 lm



**MIE001B**

E27 1x75W max



⊕ ∇ IP20 CE

**MIE006B**

LED 18W

3000K 1800 lm



**MIE002B**

E27 2x75W max



⊕ ∇ IP20 CE

**MIE007B**

LED 30W

3000K 3000 lm



**MIE003B**

E27 3x75W max



⊕ ∇ IP20 CE



# ALDRIN

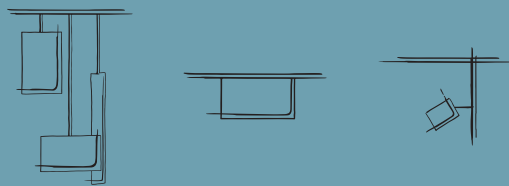

Lampada a sospensione, a soffitto e da parete dalla particolare forma a foglia. Struttura e particolari in metallo cromato e diffusore in vetro extrachiaro curvo e sagomato, sabbiato internamente ed esternamente. Cablata con attacco R7s che consente di montare lampadina LED.

Pendant, ceiling and wall lamp with a particular leaf shape. Chrome metal structure and details, diffuser in bent extra-clear glass, sanded internally and externally. R7s lamp holder that allows mounting LED lamp.

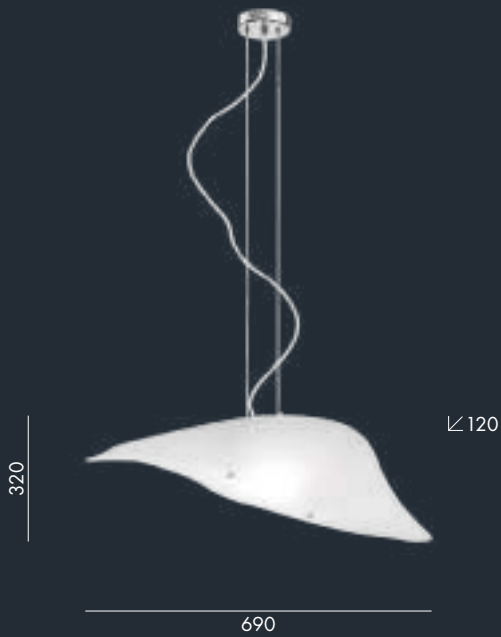

**1400-70**

R7s117 1x160W max

cavo cable L.max 1200mm

rosone ceiling rose Ø 100x23mm

⊕ ⊖ IP20 CE

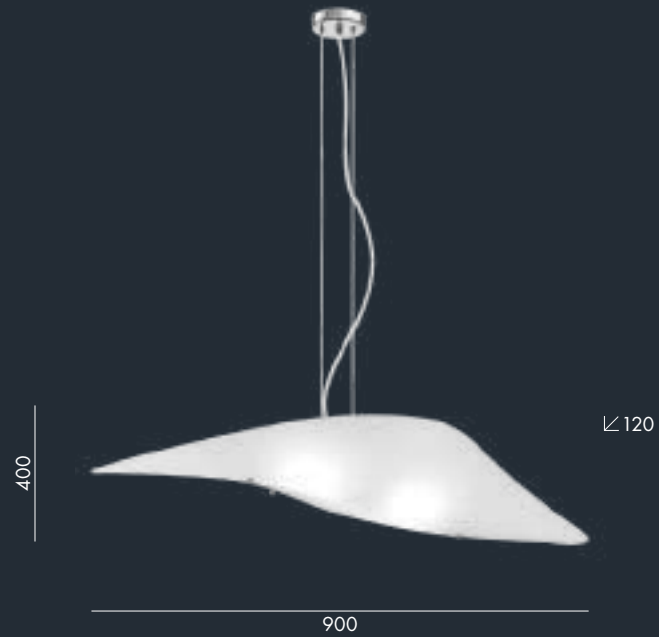

**1400-90**

R7s117 2x160W max

cavo cable L.max 1200mm

rosone ceiling rose Ø 100x23mm

⊕ ⊖ IP20 CE



**1401-70**

R7s117 1x160W max

⊕ ⊖ IP20 CE



**A.1400**

R7s117 1x120W max

⊕ ⊖ IP20 CE





# COLLINS

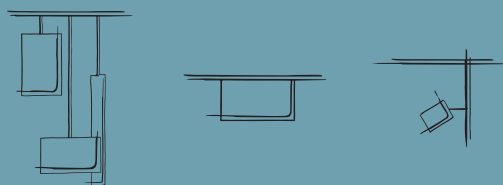

Lampada a sospensione, a soffitto e da parete con attacco E27 dal design moderno che richiama le morbide forme di una foglia. Diffusore in vetro fusione extrachiaro con venature in rilievo. Montatura e rosone in metallo cromato.

E27 pendant, ceiling and wall lamp with a modern design that recalls the rounded shape of a leaf. Extra clear fused glass diffuser with embossed grains. Chrome metal frame and ceiling rose.

MADE IN  
MURANO



**COL005**

E27 4x75W

cavo cable L.max 1000mm  
rosone ceiling rose Ø 120x40mm

⊕ ⊖ IP20 CE



550x550

∟90

**COL003**

E27 4x75W

⊕ ⊖ IP20 CE



550x550

∟90

**COL001**

E27 1x75W

⊕ ⊖ IP20 CE



310x310

∟65



# FARIS

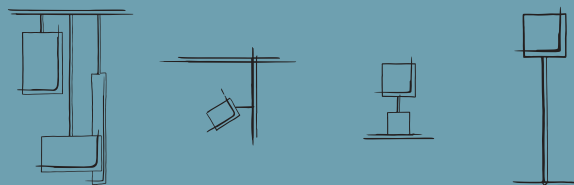

Lampada a sospensione, da parete, da tavolo e da terra cablata con attacco E27 che consente di montare lampadina LED. Struttura e particolari in metallo cromato e diffusore in vetro soffiato dalla forma minimal e squadrata.

Pendant, wall, table and floor lamp with E27 lamp holder that allows mounting LED lamp. Chrome metal structure and details, blown glass diffuser with a neat and minimal shape.





**3598-20**

E27 1x75W max

cavo cable L.max 800mm  
rosone ceiling rose 100x100x25mm

⊕ ⚡ IP20 CE



**3598-40**

E27 1x75W max

cavo cable L.max 800mm  
rosone ceiling rose 100x100x25mm

⊕ ⚡ IP20 CE



**T.3598**

E27 1x75W

⊕ ⚡ IP20 CE

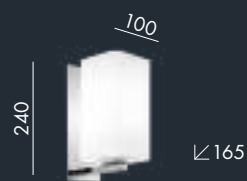

**A.3598**

E27 1x75W max

⊕ ⚡ IP20 CE



**P.3598-20**

E27 1x75W max

⊕ ⚡ IP20 CE





## KOFI

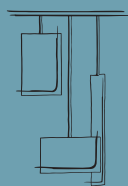

Lampada a sospensione con diffusore dalla forma conica in vetro soffiato cristallo trasparente. Struttura, portalampada e rosone in metallo cromato, cavo in PVC trasparente. Disponibile in due dimensioni; la piccola in versione singola o con kit decentramento a tre o cinque elementi. Attacco E27 che consente di montare lampadina LED.

Pendant lamp with diffuser in clear crystal blown glass of a conical shape. Structure, lamp holder and ceiling rose in chrome metal. Available in two sizes; small version as single lamp or with decentralization kit for three or five luminaires. E27 lamp holder that allows mounting LED lamp.



Ø 125 / 160



Ø 125



Ø 125

**KOF001**

E27 1x75W max - Ø 125 mm



**KOF002**

E27 1x75W max - Ø 160 mm



cavo cable L.max 2000mm  
rosone ceiling rose Ø120x25mm

⊕ ⊖ IP20 CE

**KOF003**

E27 3x75W max



cavo cable L.max 2000mm  
rosone ceiling rose Ø120x25mm

⊕ ⊖ IP20 CE

**KOF004**

E27 5x75W max



cavo cable L.max 2000mm  
rosone ceiling rose Ø120x25mm

⊕ ⊖ IP20 CE





# RENOIR

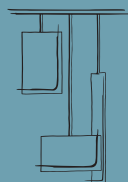

Lampada a sospensione a forma conica con diffusore in vetro soffiato cristallo con fascia satinata a copertura della fonte luminosa. Struttura e portalampada in metallo cromato. Disponibile nella versione singola e in cadute multiple, sia con rosone (a tre e sei elementi), che con kit decentramento (a tre e cinque elementi), che con barra lineare (a tre e quattro elementi).

Cone-shaped pendant lamp with diffuser in crystal blown glass with central satin area, covering the light source. Structure and lamp holder in chrome metal. Available in single version or in multiple composition, both with ceiling rose (three or six elements), with decentralization kit (three or five elements) and with linear ceiling rose (three or four elements).



**S.10610**

E27 1x75W max  
 cavo cable L.max 2000mm  
 rosone ceiling rose Ø120x25mm

⊕ ⊖ IP20 CE



**REN001**

E27 3x75W max  
 cavo cable L.max 2000mm  
 rosone ceiling rose Ø300x30mm

⊕ ⊖ IP20 CE



**REN002**

E27 6x75W max  
 cavo cable L.max 2000mm  
 rosone ceiling rose Ø500x30mm

⊕ ⊖ IP20 CE





**REN003**

E27 3x75W max

cavo cable L.max 2000mm  
rosone ceiling rose Ø120x25mm

⊕ ⊖ IP20 CE



**REN004**

E27 5x75W max

cavo cable L.max 2000mm  
rosone ceiling rose Ø120x25mm

⊕ ⊖ IP20 CE



**BS.10610-3**

E27 3x75W max

cavo cable L.max 2000mm  
rosone ceiling rose 700x40x40mm

⊕ ⊖ IP20 CE



**BS.10610-4**

E27 4x75W max

cavo cable L.max 2000mm  
rosone ceiling rose 1000x40x40mm

⊕ ⊖ IP20 CE





# JULIA

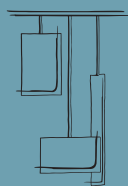

Sospensione con diffusore in vetro soffiato satinato bianco, disponibile in due dimensioni. Proposta nella versione singola o con kit decentramento a tre elementi. Cablata con attacco E27 che consente di montare lampadina LED.

Pendant lamp with diffuser in satin blown glass in white finish, available in two sizes. Available in single version or with decentralization kit for three luminaires. E27 lamp holder that allows mounting LED lamp.



**JUL001B**

E27 1x75W max  
 cavo cable L.max 1200mm  
 rosone ceiling rose Ø75x30mm

⊕ ⊖ IP20 CE



**JUL002B**

E27 1x75W max  
 cavo cable L.max 1200mm  
 rosone ceiling rose Ø100x30mm

⊕ ⊖ IP20 CE



**JUL003B**

E27 3x75W max  
 cavo cable L.max 1200mm  
 rosone ceiling rose Ø100x30mm

⊕ ⊖ IP20 CE



**JUL004B**

E27 3x75W max  
 cavo cable L.max 1200mm  
 rosone ceiling rose Ø100x30mm

⊕ ⊖ IP20 CE





# CAMBRIA



Lampada da parete e a soffitto; struttura composta da bracci flessibili in ottone satinato e alluminio lucidato, per far assumere alla lampada la forma desiderata (in versione singola, da 3, 6 o 9 bracci). Rosone e attacco a soffitto in tinta con la lampada. Attacco E14 con lampadina a vista, che consente all'utente di montare una lampadina a sua scelta, personalizzando ulteriormente il prodotto.

Wall and ceiling lamp; structure consisting of flexible arms in satin brass and polished aluminium, allowing a bespoke changing of the shape (version with 1, 3, 6 or 9 arms). Ceiling rose and wall fixing in the same colour of the lamp. E14 lamp holder with visible lamp, that allows the user to mount a light bulb of his choice and further personalize the product.







Ø 500

composizione come in foto  
as shown in picture

**3460-6**

E14 6x42W max

braccio bracket L.max 550mm

rosone ceiling rose Ø80x35mm

⊕ ⊖ IP20 CE



Ø 500

composizione come in foto  
as shown in picture

**3460-9**

E14 9x42W max

braccio bracket L.max 950mm

rosone ceiling rose Ø130x60mm

⊕ ⊖ IP20 CE



**3461-55**

E14 1x42W max

braccio bracket L.max 550mm

rosone ceiling rose Ø80x35mm

⊕ ⊖ IP20 CE



350

composizione come in foto  
as shown in picture

**A.3460-3**

E14 3x42W max

braccio bracket L.max 550mm

attacco a parete wall support Ø80x35mm

⊕ ⊖ IP20 CE





# MINX

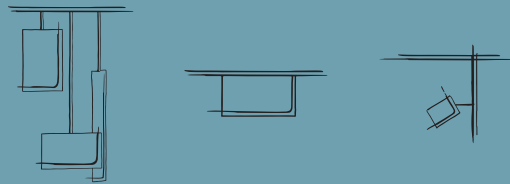

Lampada a sospensione, a soffitto e a parete; struttura composta da una fine montatura in metallo cromato con lampadine a vista da acquistare separatamente, per personalizzare ulteriormente il prodotto. Cablata con attacco E27 che consente di montare lampadina LED.

Pendant, wall and ceiling lamp; structure composed of an elegant frame in chrome metal with visible light sources, to be ordered separately in order to further customize the product. E27 lamp holder that allows mounting LED lamp.



MADE IN  
MILANO

**2597-3**

E27 3x75W

cavo cable L.max 1000mm

rosone ceiling rose Ø100x50mm

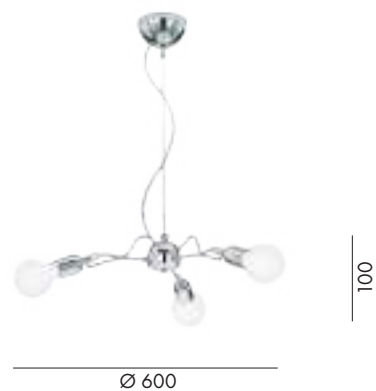

⊕ ⊖ IP20 CE

**2597-6**

E27 6x75W

cavo cable L.max 1000mm

rosone ceiling rose Ø100x50mm



⊕ ⊖ IP20 CE

**2597-12**

E27 12x75W

cavo cable L.max 1000mm

rosone ceiling rose Ø100x50mm



⊕ ⊖ IP20 CE





Ø 600

∟220

**2598-3**

E27 3x75W max

rosone ceiling rose Ø75x25mm

⊕ ∇ IP20 CE



Ø 930

∟220

**2598-6**

E27 6x75W max

rosone ceiling rose Ø75x25mm

⊕ ∇ IP20 CE



400

130

∟140

**A.2598-1**

E27 1x75W max

attacco a parete wall support Ø140x70mm

⊕ ∇ IP20 CE



400

450

∟200

**A.2598-3**

E27 3x75W max

attacco a parete wall support Ø140x70mm

⊕ ∇ IP20 CE



# BONNY



Lampada da soffitto e a parete in metallo cromato. Composta da bracci malleabili per poter creare in ogni momento un oggetto d'arredo sempre diverso. Disponibile con 12 o 19 punti luce con attacco G4 che consente di montare lampadina LED.

Wall and ceiling lamp in chrome metal. Composed by flexible arms allowing to create at any time a unique design object with ever-changing shape. Available with 12 or 19 G4 lamp holders that allow mounting LED lamp.

MADE IN  
MILANO

**5422-19**

G4 19x8W max

braccio bracket L.max 800mm

rosone ceiling rose Ø170x100mm

☐ ▽ IP20 CE



Ø 750

composizione come in foto  
as shown in picture

**A.5422-12**

G4 12x8W max

braccio bracket L.max 600mm

attacco a parete wall support Ø170x100mm

☐ ▽ IP20 CE

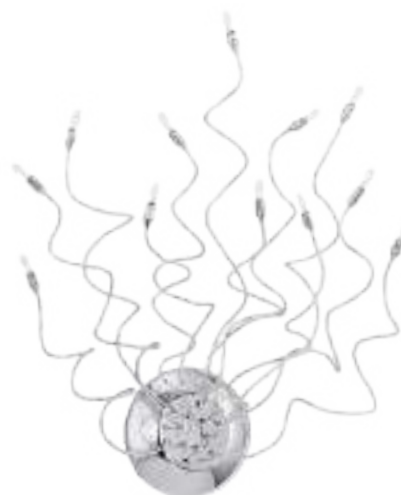

Ø 650

composizione come in foto  
as shown in picture





# LEILA

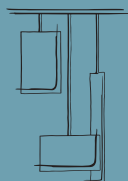

Lampada a sospensione in ferro bronzato con diffusore in cristallo trasparente a forma di goccia a copertura della lampadina. Attacco E27 con lampadina a vista che consente all'utente di montare una lampadina a sua scelta, personalizzando ulteriormente il prodotto. Prodotto proposto in versione singola o con doppio cavo, che consente il montaggio dell'apparecchio in cadute multiple, con aggancio sul cavo o direttamente a soffitto, con possibilità di deviare il punto luce da parete. Rosone da ordinare separatamente, anche per la versione singola.

Pendant lamp in bronzed iron and diffuser in clear teardrop-shape crystal that covers the light bulb. Luminaire with visible lamps with E27 lamp holder that allows the user to mount a light bulb of his choice and further personalize the product. Available in single version or with double cable that allows mounting as multiple elements, on steel cable or on the ceiling, allowing decentralization of light source. Ceiling/wall rose to be ordered separately, even in single version.

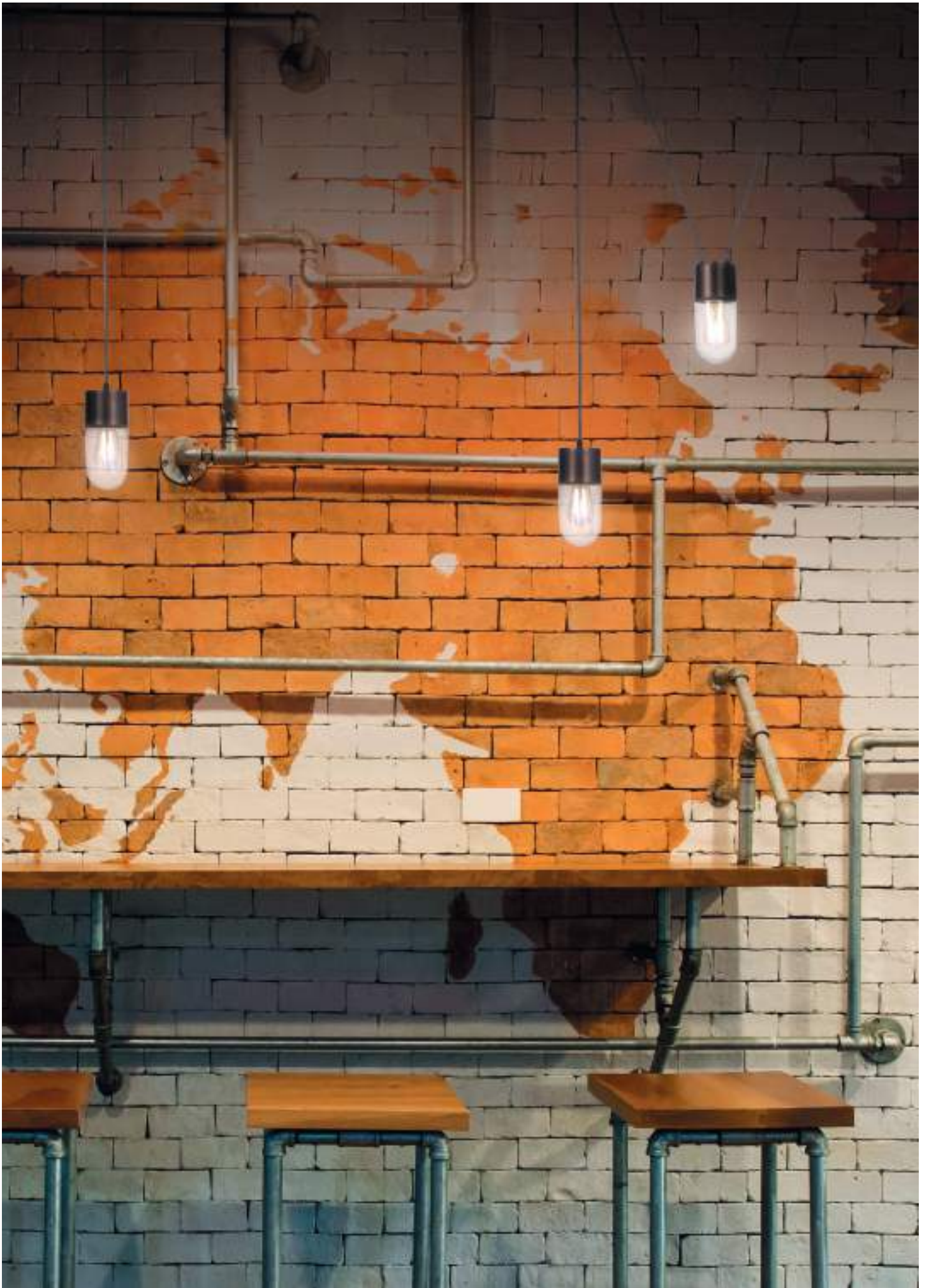



**LEI001**

E27 1x75W max  
cavo cable L.max 3000mm

⊕ ⊖ IP20 CE



**LEI002**

E27 1x75W max  
cavo cable L.max 3000mm

⊕ ⊖ IP20 CE



da completare con il rosone to be completed with ceiling rose

**ACCESSORI - SISTEMA / ACCESSORIES - SYSTEM**



**LEI004**

Rosone da parete e soffitto e elemento di connessione per installazione su cavo d'acciaio  
Wall and ceiling rose, connection kit for cable installation



**LEI003**

Cavo d'acciaio  
5 mt - Ø 3mm  
max 3 lampade

Steel cable  
5 mt - Ø 3mm  
max 3 lamps

**LEI005**

Cavo d'acciaio  
10 mt - Ø 4mm  
più di 3 lampade

Steel cable  
10 mt - Ø 4mm  
more than 3 lamps

**LEI006**

Cavo d'acciaio  
20 mt - Ø 4mm  
più di 3 lampade

Steel cable  
20 mt - Ø 4mm  
more than 3 lamps



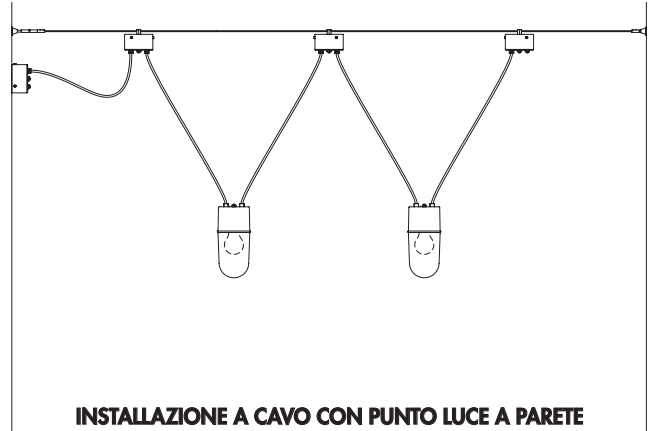

**INSTALLAZIONE A CAVO CON PUNTO LUCE A PARETE**  
CABLE INSTALLATION WITH WALL LIGHT SOURCE



**INSTALLAZIONE A SOFFITTO / CEILING INSTALLATION**



# AISHA



Lampada a sospensione e da parete con struttura, catena e rosone in ferro e diffusore in cristallo trasparente. Disponibile in finitura bronzo e bianca, con attacco E27 con lampadina a vista che consente all'utente di montare una lampadina a sua scelta, personalizzando ulteriormente il prodotto.

Pendant and wall lamp with iron structure, chain and ceiling rose and diffuser in clear crystal. Available in bronze or white finish with E27 lamp holder with visible lamps, that allows the user to mount a light bulb of his choice and further personalize the product.



MADE IN  
MILANO







**AIS003**

E27 3x75W max  
 cavo cable L.max 1200mm  
 rosone ceiling rose 350x50x25mm



⊕ ⊖ IP20 CE



**AIS001**

E27 1x75W max  
 cavo cable L.max 1200mm  
 rosone ceiling rose Ø90x50mm



⊕ ⊖ IP20 CE



**AIS002**

E27 1x75W max



⊕ ⊖ IP20 CE





# UMA

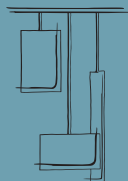

Lampada a sospensione con diffusore in metallo verniciato a polveri, dalla forma in stile industriale. Portalampada E27, che consente di montare una lampadina LED. Disponibile nei colori bianco, nero e bronzo, con interno e rosone in tinta. Cavo in PVC in tinta nelle versioni nera e bianca, cavo nero per la versione bronzo.

Pendant lamp with powder-coated metal diffuser in industrial style shape. E27 lamp holder that allows mounting LED lamp. Available in white, black and bronze finish, with interior matching to the lamp frame. PVC cable matching to the structure in the black and white versions, black cable on the bronze version.



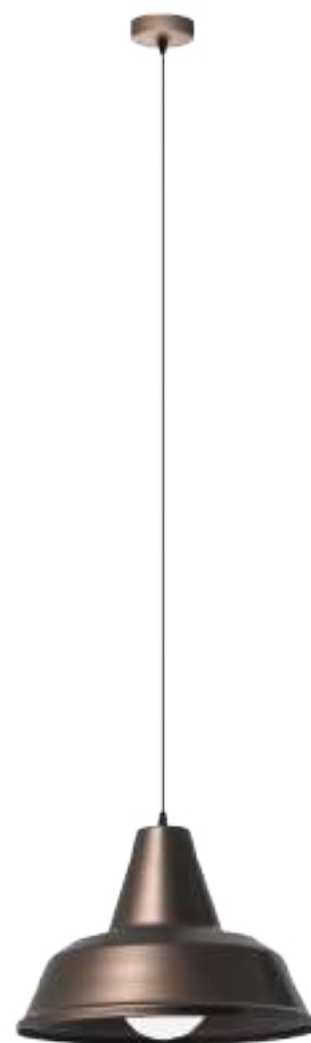
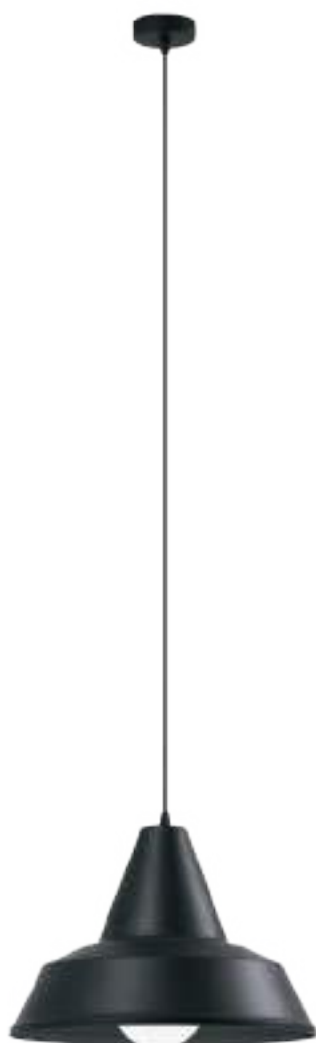

290

Ø 400

**UMA001**

E27 1x75W max  
cavo cable L.max 1200mm  
rosone ceiling rose Ø100x25mm



⊕ ⚡ IP20 CE

B N BZ



# SALLY

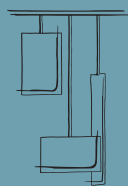

Lampada a sospensione con LED integrato (3000K) o con attacco E27 che consente di montare lampadina LED. Struttura di alluminio verniciato a polveri disponibile in due finiture (grigio e bianco). Cavo di sospensione e rosone in tinta con il corpo lampada.

Pendant lamp in LED version (3000K) or with E27 lamp holder that allows mounting LED lamp. Powder coated extruded aluminium body available in two finishes (grey and white). Ceiling rose and suspension cable in the same colour of the luminaire.



**SAL001**

LED 30W  
3000K 2700 lm



**SAL002**

E27 1x60W max



cavo cable L.max 1500mm  
rosone ceiling rose Ø100x80mm

⊕ ⚡ IP20 CE





# HOLDEN

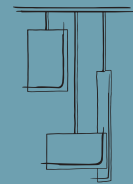

Lampada a sospensione in alluminio dalla forma in stile industriale e diffusore in vetro trasparente. Disponibile nelle finiture bianco, grigio, nero, oro satinato e rame. Cavo in PVC trasparente, rosone in tinta. Attacco E27 che consente di montare lampadina LED.

Pendant lamp in aluminium with an industrial-style shape and diffuser in clear glass. Available in white, grey, black, satin gold and copper finishes. PVC clear cable, ceiling rose in the same colour of the body. E27 lamp holder that allows mounting LED lamp.





460

Ø 400

**5205**

E27 1x75W max

cavo cable L.max 800mm

rosone ceiling rose Ø 120x70mm



⊕ ⊖ IP20 CE

B

GR

N

OS

RA



# BEK

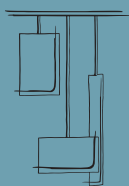

Lampada a sospensione in stile industriale con struttura in metallo nichelato e diffusore in vetro rigato. Disponibile in due misure, cablata con attacco E27 che consente di montare lampadina LED.

Pendant lamp of industrial style with structure in nickel-plated metal and diffuser in grained glass. Available in two sizes, E27 lamp holder that allows mounting LED lamp.



**794-30**   
E27 1x75W max - Ø 300 mm

**794-40**   
E27 1x75W max - Ø 400 mm

cavo cable L.max 800mm  
rosone ceiling rose Ø 130x70mm

  **IP20 CE**



**MADE IN MILANO**



compatibile con lampadine LED con tecnologia smart (pag. 730)  
suitable for smart LED light bulbs (pag. 730)



# SNAP

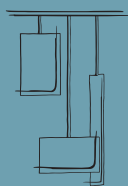

Lampada a sospensione in stile industriale in alluminio. Due diverse forme con diverse dimensioni e proporzioni. Cablata con attacco E27 che consente di montare lampadina LED.

Pendant lamp of industrial style, made in aluminium. Two different shapes of various sizes and proportions. E27 lamp holder that allows mounting LED lamp.

MADE IN  
MILANO



**2166**

E27 1x75W max

cavo cable L.max 1000mm

rosone ceiling rose Ø 100x60mm



⊕ ⊖ IP20 CE



**2168**

E27 1x75W max

cavo cable L.max 1000mm

rosone ceiling rose Ø 100x60mm



⊕ ⊖ IP20 CE



# VIVIEN

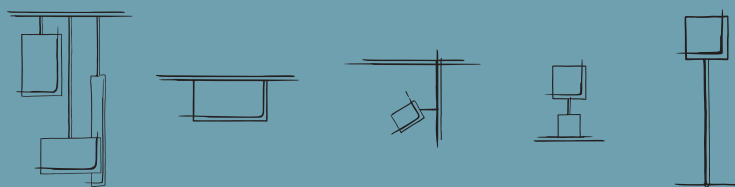

Lampada a sospensione, a soffitto, da parete, da tavolo e da terra con paralume in tessuto trevira ignifugo. Struttura in metallo verniciato bianco opaco con particolari cromo. Tappo di chiusura per sospensione e plafoniera in PVC coperto da tessuto, la versione a soffitto con sbraccio ruota di 355°. Disponibile in due finiture (avorio e grigio), in versione LED (2700K) o con attacco tradizionale (E27) che consente di montare lampadina LED.

Pendant, ceiling, wall, floor and table lamp with lampshade in fire-proof trevira fabric. Structure in white painted metal with chrome details. Cover for pendant and ceiling lamp in self-extinguishing PVC covered by fabric, ceiling lamp with cantilevered arm adjustable of 355°. Available in two finishes (ivory and grey) in the LED version (2700K) and with traditional lamp holder (E27) that allows mounting LED lamp.



MADE IN  
MILANO



**10771-60-LED**

LED 39W  
2700K 3600 lm



**10771-60**

E27 3x75W max



cavo cable L.max 1200mm  
rosone ceiling rose Ø120x30 mm

⊕ ⊖ IP20 CE



**10771-50**

E27 1x75W max  
cavo cable L.max 1200mm  
rosone ceiling rose Ø120x30 mm



⊕ ⊖ IP20 CE

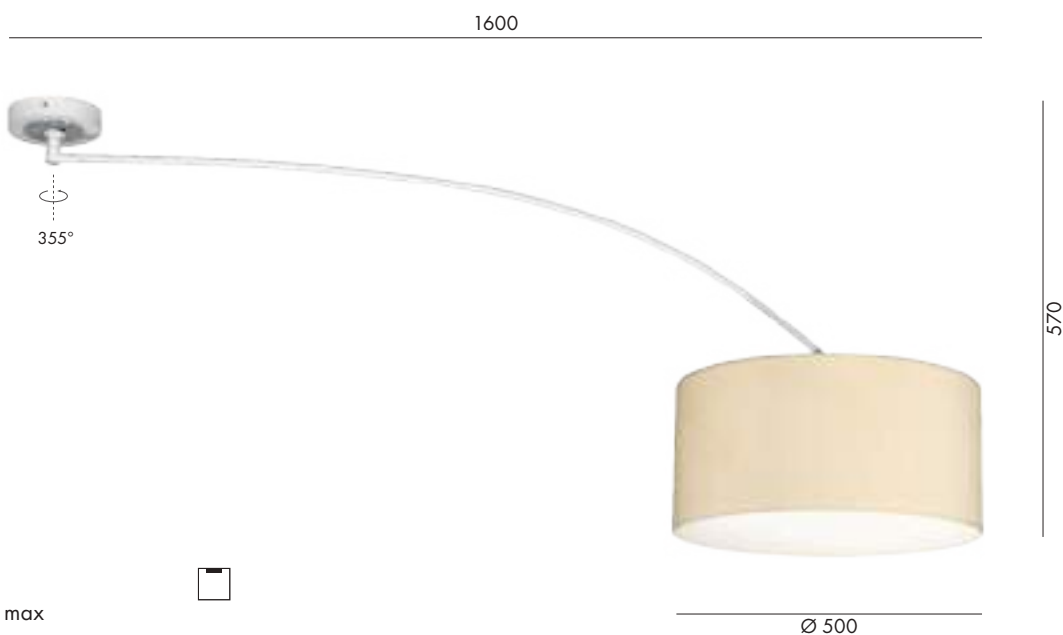

**10771**

E27 1x75W max  
rosone ceiling rose Ø150x35 mm



⊕ ⊖ IP20 CE





**10770-60-LED**

LED 39W  
2700K 3600 lm



**10770-60**

E27 3x75W max



⊕ ⊖ IP20 CE

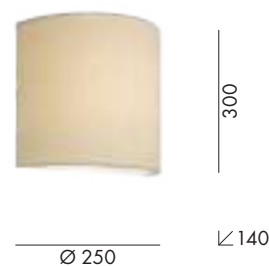

**A.10770-LED**

LED 13W  
2700K 1200 lm



**A.10770**

E27 1x75W max



⊕ ⊖ IP20 CE



**P.10770-40**

E27 1x75W max



⊕ ⊖ IP20 CE

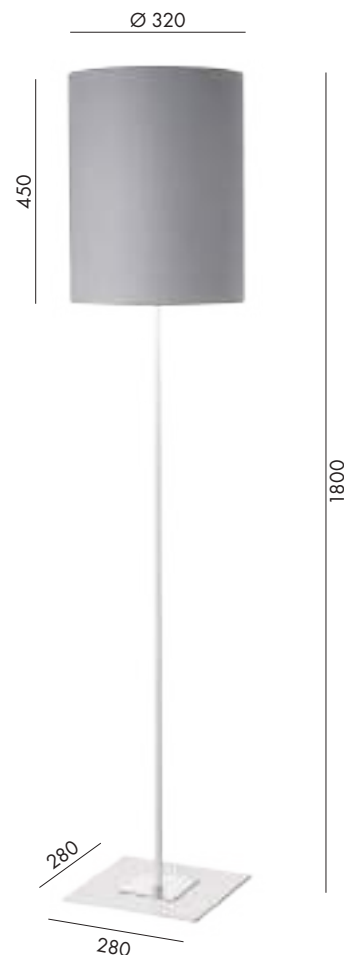

**T.10770**

E27 1x75W max



⊕ ⊖ IP20 CE







# BYRON

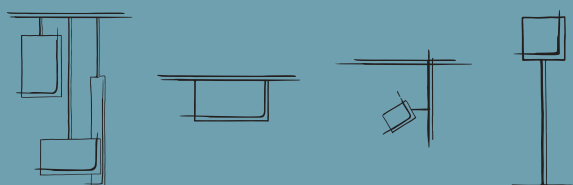

Lampada a sospensione, a soffitto, da parete e da terra con diffusore in tessuto plissé ignifugo. Nella versione bassa della sospensione e della plafoniera (h 120mm) chiusura inferiore in policarbonato, a protezione della fonte luminosa. Struttura e particolari in metallo laccato bianco, cavo della sospensione trasparente. Disponibile nei colori avorio e grigio; sospensione disponibile in quattro misure, plafoniera in due diversi diametri. Attacco E27 che consente di montare lampadina LED.

Pendant, ceiling wall and floor lamp with diffuser in fireproof pleated fabric. Ceiling and pendant low versions (h 120mm) have a bottom cover in polycarbonate, to protect the light source. White lacquered metal structure and details, clear suspended wiring cable. Available in ivory and grey colours; pendant lamp available in four sizes, ceiling lamp in two different diameters. E27 lamp holder that allows mounting LED lamp.



**BYR003**

E27 1x75W max  
 cavo cable L.max 1200mm  
 rosone ceiling rose Ø75x50mm

⊕ ⊖ IP20 CE

AV GR



**BYR004**

E27 1x75W max  
 cavo cable L.max 1200mm  
 rosone ceiling rose Ø75x50mm

⊕ ⊖ IP20 CE

AV GR



**BYR002**

E27 2x75W max  
 cavo cable L.max 1200mm  
 rosone ceiling rose Ø120x30mm

⊕ ⊖ IP20 CE

AV GR



**BYR001**

E27 3x75W max  
 cavo cable L.max 1200mm  
 rosone ceiling rose Ø120x30mm

⊕ ⊖ IP20 CE

AV GR





**BYR006**

E27 2x75W max

⊕ ⊖ IP20 CE

AV GR



**BYR005**

E27 3x75W max

⊕ ⊖ IP20 CE

AV GR

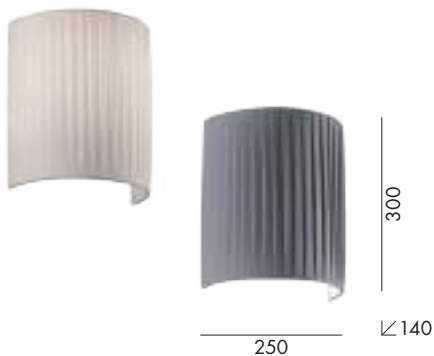

**BYR007**

E27 1x75W max

⊕ ⊖ IP20 CE

AV GR



**T.10760**

E27 1x75W max

⊕ ⊖ IP20 CE

AV GR

custom  
made

Personalizzabile nel colore del tessuto del diffusore.  
Colour of the lampshade available upon request.



B G R VI V VOL MA N



compatibile con lampadine LED con tecnologia smart (pag. 730)  
suitable for smart LED light bulbs (pag. 730)



# NERELLO

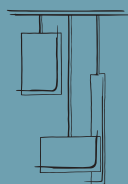

Lampada a sospensione con diffusore dalla forma troncoconica essenziale e semplice in cotone accoppiato a PVC autoestinguente. Proposta nei colori avorio, rosso e antracite; particolari in metallo laccato bianco, cavo di sospensione in PVC trasparente. Cablata con attacco E27 che consente di montare lampadina LED.

Pendant lamp with diffuser of essential and simple shape in cotton matched to self-extinguishing PVC. Available in ivory, red and anthracite colours; details in white lacquered metal, transparent PVC suspension cable. E27 lamp holder that allows mounting LED lamp.





**NER001**

E27 1x75W max

cavo cable L.max 1200mm

rosone ceiling rose Ø75x50mm



⊕ ⊖ IP20 CE

AV AN R

Ø 500



Personalizzabile nel colore del tessuto e nella forma del diffusore.

Colour and shape of the lampshade available upon request.



B G VI V VOL MA N



compatibile con lampadine LED con tecnologia smart (pag. 730)  
suitable for smart LED light bulbs (pag. 730)



# LINA





Lampada a soffitto quadrata e tonda in tessuto maglia elasticizzata, con effetto quadrettato in finitura bianca. Tessuto removibile per una pratica manutenzione. Struttura in metallo bianco opaco. Disponibile in due misure e relative potenze, con attacco E27 che consente di montare lampadina LED.

Square and round ceiling lamp in stretch jersey fabric with checkered effect, white finish. Removable fabric for practical maintenance. Structure in white metal. Available in two sizes and related powers, with E27 lamp holder that allows mounting LED lamp.

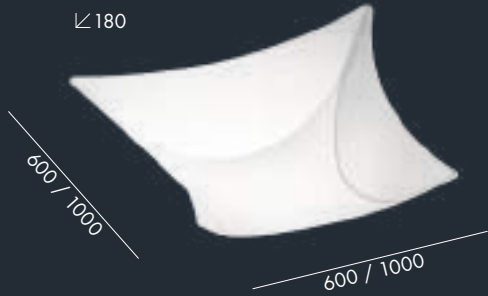
MADE IN  
MILANO



**10720-60-B**   
E27 2x75W max - L.600 mm

**10720-100-B**   
E27 3x75W max - L.1000 mm

  IP20 CE



**10721-60-B**   
E27 2x75W max - Ø 600 mm

**10721-100-B**   
E27 3x75W max - Ø 1000 mm

  IP20 CE





# TASCA



Incasso da parete in gesso a scomparsa totale (frameless) a luce indiretta, installabile su superfici in cartongesso. Struttura che si adatta e si nasconde nella superficie di installazione, con possibilità di pitturare il corpo in finitura colore a propria scelta, adattandolo alla parete su cui viene montata. Proposta in due versioni: con un taglio di luce centrale (attacco R7s) o con una struttura in aggetto verso l'esterno (attacco E14). Permette effetti luminosi particolari, in cui la luce sembra provenire direttamente dal volume pieno della parete.

Frameless plaster recessed lamp, with indirect light emission, suitable for wall plasterboard installation. Structure that hides in the installation surface; for its plaster body it is possible to paint it as desired, adapting it to the colour of the installation surface. Available in two versions: with central light cut (R7s lamp holder) and with an outwards structure (E14 lamp holder). Light appears to come directly from the full wall plane, allowing particular light effects.



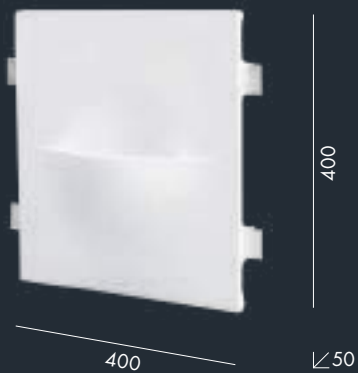

**TAC001**

R7s117 1x160W max

⊕ ▽ IP20 CE



**TAC002**

E14 2x40W max

⊕ ▽ IP20 CE



corpo verniciabile in finitura colore a scelta  
paint the plaster body surface as desired



# VITTORI



Lampada da parete in gesso biemissione, con struttura cava dalle dimensioni contenute, proposta in versione quadrata o tondeggiante. Cablata con attacco standard, che consente di montare lampadina LED. Struttura in gesso, che consente la pittura del corpo in finitura colore a propria scelta.

Wall plaster lamp, with direct-indirect light emission. Hollow structure of small dimensions, available in square or rounded shape. Standard lamp holder, that allows mounting LED lamp. Plaster structure, free chance to paint the body surface as desired.





**VIT001**

G9 1x33W max



⊕ ⊖ IP20 CE



**VIT002**

G9 1x33W max



⊕ ⊖ IP20 CE



**A.7227-10**

GU10 2x40W max



⊕ ⊖ IP20 CE

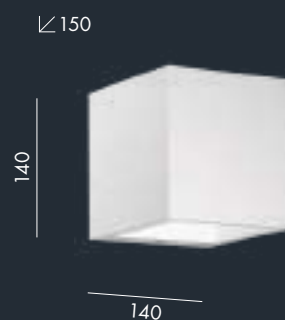

**A.7227-15**

E14 1x40W max



⊕ ⊖ IP20 CE



corpo verniciabile in finitura colore a scelta  
paint the plaster body surface as desired



# POLO



Lampada da parete a LED (2700K), dalla forma semplice e quadrata, a luce indiretta monoemissione. Struttura in gesso, che consente la pittura del corpo in finitura colore a propria scelta. Proposta in due misure e relative potenze.

Indirect light wall LED lamp (2700K), with a simple and square shape. Free chance to paint the plaster body surface as desired. Available in two sizes and related powers.



## POL001

LED 13,5W - L.350 mm  
2700K 1250 lm



## POL002

LED 27W - L.600 mm  
2700K 2500 lm



⊕ ⚡ IP20 CE



corpo verniciabile in finitura colore a scelta  
paint the plaster body surface as desired

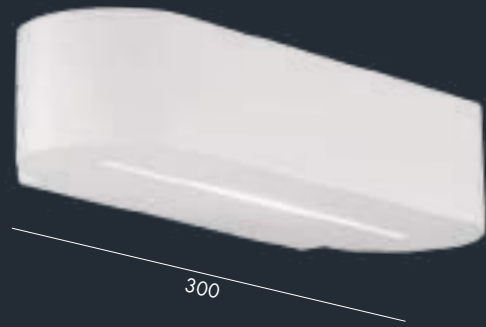

**TOO001**

R7s117 1x100W max



⊕ ⊖ IP20 CE



corpo verniciabile in finitura colore a scelta  
paint the plaster body surface as desired

# TOOL



Lampada da parete biemissione, luce indiretta diffusa, per illuminare l'ambiente, fascio verso il basso reso con un semplice e sottile taglio di luce. Forma tondeggiante, struttura in gesso, che consente la pittura del corpo in finitura colore a propria scelta. Cablata con attacco R7s che consente di montare lampadina LED.

Direct-indirect light wall lamp, with diffused indirect emission and direct light with blade effect. Rounded shape plaster body, free chance to paint the surface as desired. R7s lamp holder that allows mounting LED lamp.



# ELMER



Lampada da parete in gesso biemissione, proposta in forma rettangolare, in diverse dimensioni e relative potenze. Cablata con attacco standard, che consente di montare lampadina LED, con diffusore in vetro pirex satinato a copertura della fonte luminosa. Struttura in gesso, che consente la pittura del corpo in finitura colore a propria scelta.

Wall plaster lamp, with direct-indirect light emission. Rectangular body, available in different sizes and related powers. Standard lamp holder, that allows mounting LED lamp, with satin pyrex glass diffuser to cover the light source. Plaster structure, free chance to paint the body surface as desired.





**A.7225-E27**

E27 1x60W max



⊕ ∇ IP20 CE

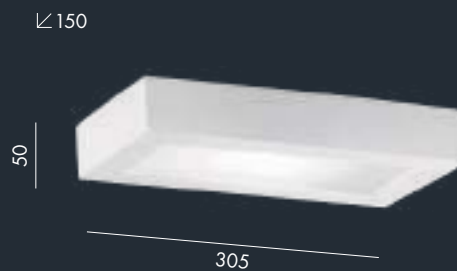

**A.4363**

R7s117 1x80W max



⊕ ∇ IP20 CE



**A.7237-35**

G9 2x48W max



⊕ ∇ IP20 CE

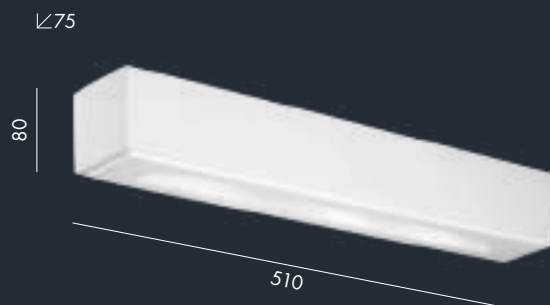

**A.7237-50**

G9 3x48W max



⊕ ∇ IP20 CE



corpo verniciabile in finitura colore a scelta  
paint the plaster body surface as desired



# DUFFY



Lampada da parete in gesso a luce indiretta, proposta in forma rettangolare in diverse dimensioni. Struttura in gesso, che consente la pittura del corpo in finitura colore a propria scelta. Attacco R7s, che consente di montare lampadina LED.

Wall plaster lamp, with indirect light emission. Rectangular body, available in different sizes. Plaster structure, free chance to paint the body surface as desired. R7s lamp holder, that allows mounting LED lamp.

**A.4362**

R7s117 1x120W max



⊕ ▽ IP20 CE

∟100



**A.7226-30R**

R7s117 1x120W max



⊕ ▽ IP20 CE

∟100

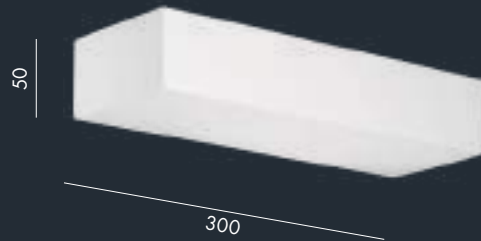

**A.7233**

R7s117 1x120W max



⊕ ▽ IP20 CE

∟165



corpo verniciabile in finitura colore a scelta  
paint the plaster body surface as desired



# RAVEL



Lampada da parete in gesso a luce indiretta o biemissione, proposta in forma tondeggiante in diverse dimensioni. Struttura in gesso, che consente la pittura del corpo in finitura colore a propria scelta. Vetro pirex satinato (per codice A.4356-30) a copertura della fonte luminosa e per un'omogenea diffusione della luce anche frontale. Attacco R7s o E27, che consentono di montare lampadina LED.

Wall plaster lamp, with direct-indirect light emission or indirect only. Rounded body, available in different sizes. Plaster structure, free chance to paint the body surface as desired. Satin pyrex glass diffuser (A.4356-30) to cover the light source and for diffused and frontal light emission. R7s or E27 lamp holders, that allow mounting LED lamp.



**A.5153**  
R7s117 1x160W max

---

⊕ ∇ IP20 CE

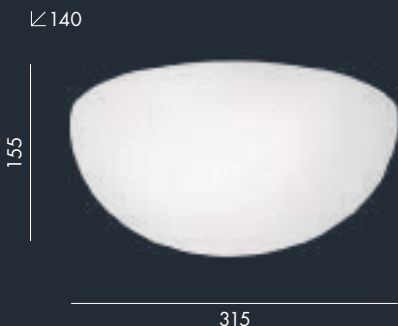

**A.7235**  
E27 1x75W max

---

⊕ ∇ IP20 CE



**A.5154**  
R7s117 1x160W max

---

⊕ ∇ IP20 CE



**A.5157**  
R7s117 1x160W max

---

⊕ ∇ IP20 CE

**A.4356-30**  
R7s117 1x120W max

---

⊕ ∇ IP20 CE



corpo verniciabile in finitura colore a scelta  
paint the plaster body surface as desired



# DRILL

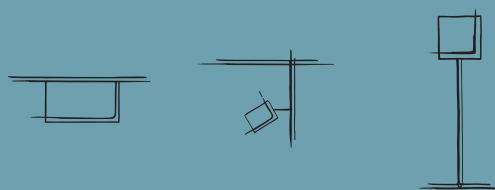

Lampada da soffitto, da parete e da terra con attacco R7s che consente di montare lampadina LED. Struttura in metallo cromato con diffusore in vetro pirex satinato orientabile sull'asse orizzontale, con diffusione luminosa a 360°.

Wall, floor and ceiling lamp with R7s lamp holder that allows mounting LED lamp. Chrome metal structure with satin pyrex glass diffuser adjustable on the horizontal axis, with 360° light emission.



**10301-20**

R7s117 1x120W max

rosone ceiling rose Ø 100x30mm

⊕ ⊖ IP20 CE

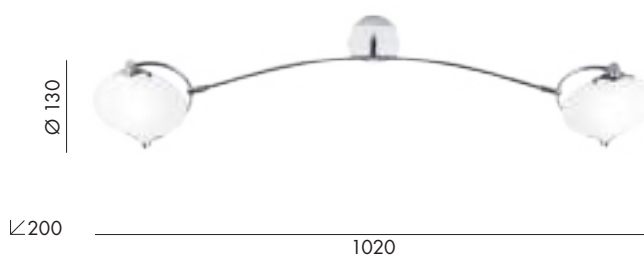

**10302-100**

R7s117 2x120W max

rosone ceiling rose Ø 100x30mm

⊕ ⊖ IP20 CE



**A.10301-20**

R7s117 1x120W max

attacco a parete wall support Ø 100x30mm

⊕ ⊖ IP20 CE

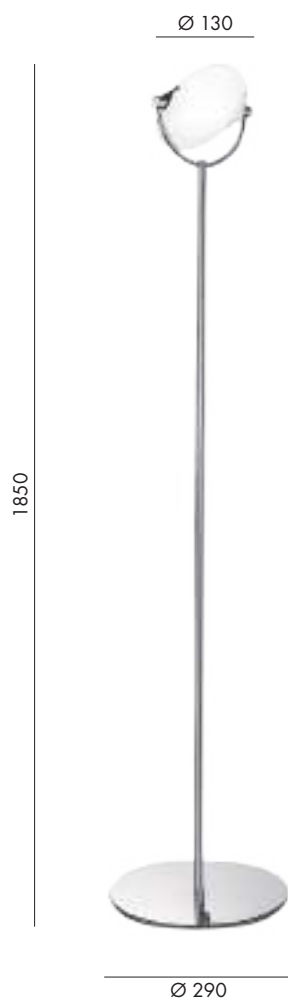

**T.10301**

R7s117 1x120W max

⊕ ⊖ IP20 CE





# HARPER

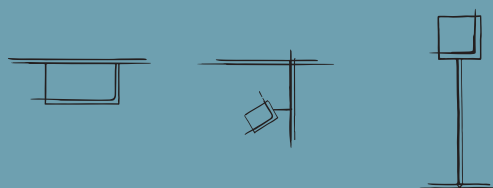

Lampada da soffitto, da parete e da terra con attacco R7s che consente di montare lampadina a LED; struttura in metallo cromato o in finitura oro satinato, grigio, nero e bianco con diffusore in vetro pirex serigrafato per un'ottima diffusione della luce.

Ceiling, wall and floor lamp with R7s lamp holder that allows mounting LED lamp. Structure in chrome metal, or in satin gold, grey, black and white finishes with pyrex glass diffuser for a diffused light emission.





**3183-1**

R7s117 1x160W max  
rosone ceiling rose Ø120x85mm

⊕ ⊖ IP20 CE [B] [CR] [GR] [N] [OS]



**A.3182**

R7s117 1x160W max  
attacco a parete wall support Ø120x85mm

⊕ ⊖ IP20 CE [B] [CR] [GR] [N] [OS]



**T.3182**

R7s117 1x240W max

⊕ ⊖ IP20 CE [B] [CR] [GR] [N] [OS]



Personalizzabile nella colorazione della struttura in alluminio.  
Colour of the aluminium body available upon request.



T MA



# DARRYL

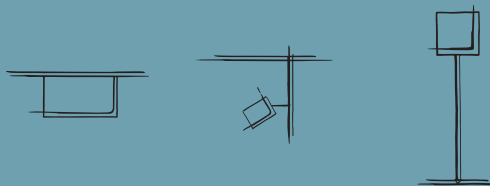

Lampada da soffitto, da parete e da terra composta da un braccio orientabile in fase di montaggio tramite una vite che fissa la struttura nella posizione desiderata. Struttura in metallo cromato, diffusore in vetro pirex serigrafato per un'ottimale diffusione della luce. Versione a parete con elemento rigido per spostamento del punto luce.

Ceiling, wall and floor lamp composed by an adjustable arm that can be fixed with a screw in the required position once mounted. Chrome metal structure and pirex glass diffuser for diffused light emission. Wall version with structure for moving the light source.

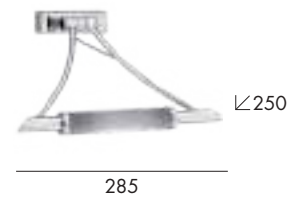
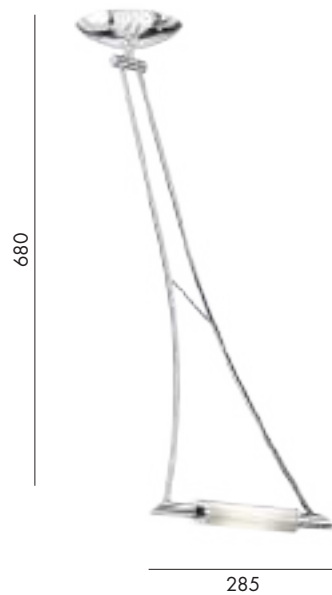

**3350**

R7s117 1x160W max  
rosone ceiling rose Ø120x35mm



⊕ ⊖ IP20 CE

**3350-1**

R7s117 1x160W max  
rosone ceiling rose Ø120x35mm



⊕ ⊖ IP20 CE

**A.3350-1**

R7s117 1x160W max  
attacco a parete wall support 85x40x20mm



⊕ ⊖ IP20 CE

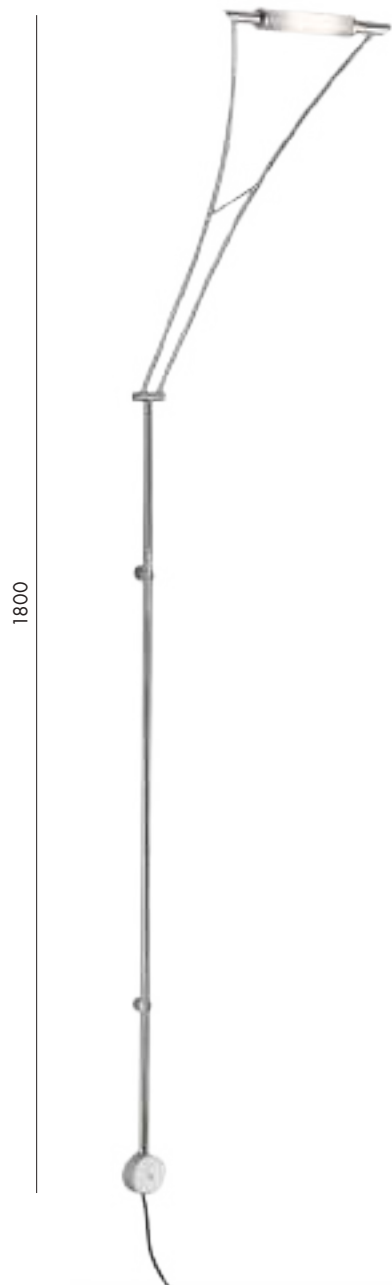

1800

**A.3350-185**

R7s117 1x160W max



⊕ ⊖ IP20 CE Ⓢ

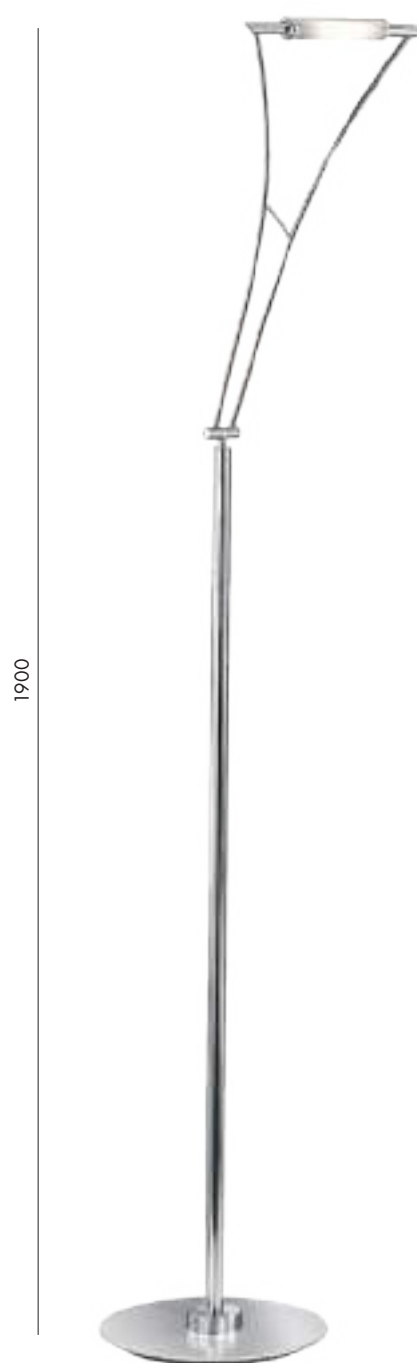

1900

Ø 320

**T.3350-1**

R7s117 1x160W max



⊕ ⊖ IP20 CE Ⓢ



# TESLA



Lampade da parete e da soffitto con struttura in metallo verniciato bianco (fissa o orientabile) e diffusore in vetro satinato. Proposta in diverse misure e relative potenze con portalampada standard o sorgente LED integrata (2700K).

Wall and ceiling lamp with metal structure white painted (fixed or adjustable) and satin glass diffuser, available in different sizes and related powers, with standard lamp holder or LED integrated source (2700K).



**A.8805-LED-B**

LED 10W  
2700K 1000 lm



**A.8805-B**

G9 1x48W max



⊕ ▽ IP20 CE

∟170



**A.8819-14-B**

G9 1x48W max



⊕ ▽ IP20 CE

∟170



**A.8819-23-B**

R7s117 1x120W max



⊕ ▽ IP20 CE

∟170

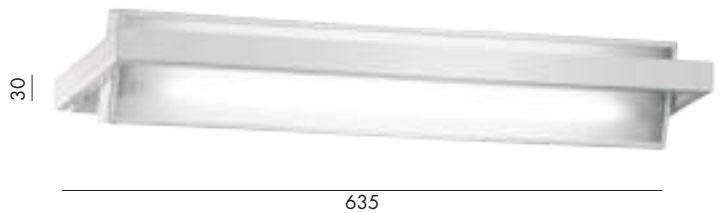

**A.8819-64-B**

G5 2x24W max



⊕ ▽ IP20 CE





# KLAUS



Lampada da parete e da tavolo a LED (3000K) realizzata in pressofusione di alluminio verniciato bianco o grigio. Alimentatore integrato. Versione da tavolo con accensione (on/off) touch; le versioni a parete possono essere installate anche in ambienti esterni (IP54).

Wall and table LED lamp (3000K) with die-cast aluminium body, available in white or grey finishes. Integrated LED driver. Table version with touch switch on/off; the wall version can be installed in outdoor environments (IP54).

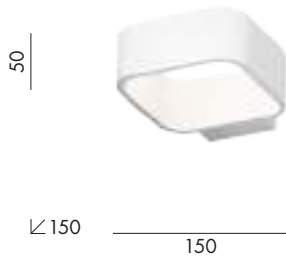

**A.10349-15**  
LED 2,7W  
3000K 270 lm



⊕ ▽ IP54 CE

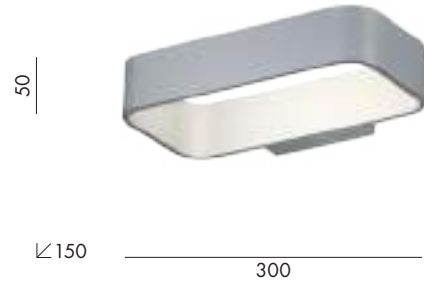

**A.10349-30**  
LED 5,4W  
3000K 500 lm



⊕ ▽ IP54 CE

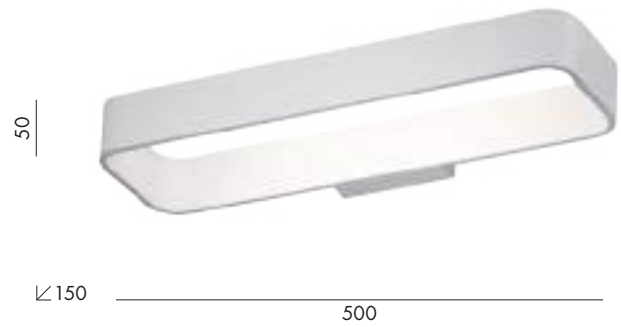

**A.10349-50**  
LED 8,1W  
3000K 810 lm



⊕ ▽ IP54 CE





**P.6187**

LED 8,1W  
3000K 540 lm



□ ▽ IP40 CE



**P.6188**

LED 6W  
3000K 540 lm



□ ▽ IP40 CE





# NELSON



Lampada LED da parete biemissione (2700K) dal design minimal e semplice, dalla linea sottile e dimensioni ridotte (solo 30mm di altezza) in metallo laccato bianco opaco o nero opaco con schermo in policarbonato a copertura della fonte luminosa.

Direct and indirect wall LED lamp (2700K) with minimal and simple design, thin line and small sizes (only 30mm high) with white or black lacquered metal structure. Polycarbonate cover to hide the light source.



**NEL001**

LED 13,5W  
2700K 1250 lm



⊕ ⚡ IP20 CE



**custom**  
made

Personalizzabile nella colorazione della struttura in metallo.  
Colour of the metal body available upon request.



ORO ARG RA



# KEATS



Lampada da parete biemissione con struttura in ottone, proposta in versione cromata, laccata bianca o nera. Saldature invisibili, pirex retinato che protegge la sorgente luminosa e impedisce l'abbagliamento. Cablata con attacco R7s che consente di montare lampadina LED.

Direct and indirect wall lamp with brass structure. Available in chrome finish or lacquered white or black. Hidden welds, anilox pyrex protecting the light source and preventing glares. R7s lamp holder that allows mounting LED lamp.

MADE IN MILANO



**A.1173-25**

R7s117 1x120W max



⊕ ⚡ IP20 CE





# OPTIMA



Lampada da parete biemissione lineare in alluminio spazzolato con diffusore in vetro satinato. Proposta in diverse misure e relative potenze, con attacco G5 o R7s, che consentono di montare lampadina LED.

Direct and indirect light wall lamp, in brushed aluminium with satin glass diffuser. Available in different sizes and related powers, with G5 or R7s lamp holders that allow mounting LED lamp.



**A.6523** 

R7s78 1x80W max - L.150 mm

**A.6524** 

R7s117 1x120W max - L.250 mm

**A.6526** 

R7s78 2x80W max - L.500 mm

⊕ ⊖ IP20 CE



**A.6554-8** 

G5 2x8W max - L.325 mm

**A.6554-14** 

G5 2x14W max - L.585 mm

**A.6554-21** 

G5 2x21W max - L.885 mm

⊕ ⊖ IP20 CE



# FREDDY



Lampada da parete dal design pulito a luce indiretta con sorgente LED (3000K). Struttura in alluminio pressofuso verniciato. Disponibile in due forme e in finitura bianca.

Indirect light wall LED lamp (3000K), with a minimal design. Painted die-cast aluminium structure in white finish, available in two shapes.



**A.10354-B**

LED 6W  
3000K 540 lm



⊕ ▽ IP20 CE



**A.10355-B**

LED 6W  
3000K 540 lm



⊕ ▽ IP20 CE





# EDITH



Lampada a parete e da soffitto in metallo. La versione a soffitto presenta uno schermo frontale in vetro temperato serigrafato bianco (sia nella versione bianca che in quella nera) per un'ottimale diffusione della luce. Nell'applicque (luce biemissione) lo schermo a protezione della fonte luminosa è in acciaio inox lucido nella versione nera, in metallo laccato bianco nella versione bianca. Apparecchio proposto con scheda a LED a tensione di rete (3000K) o attacco R7s che consente di montare lampadine LED.

Metal wall and ceiling lamp. The ceiling version is available with a front diffuser in white tempered glass (for both white and black versions) for diffused light emission. Wall version with direct-indirect light and cover in polished stainless steel in the black version and in white lacquered metal in the white version. Lamp available with LED board (3000K) or R7s lamp holder that allows mounting LED lamp.



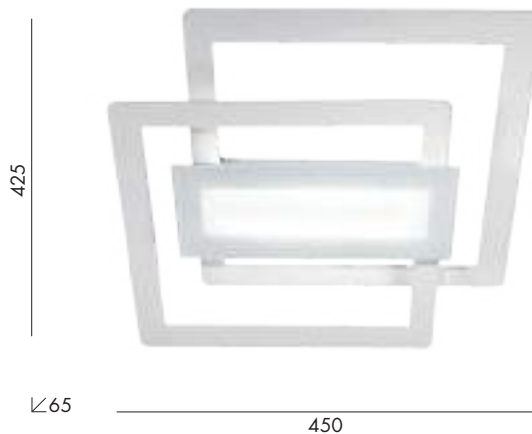

**EDI003**

LED 13,5W  
3000K 1250 lm



**EDI004**

R7s117 1x120W max



⊕ ⚡ IP20 CE

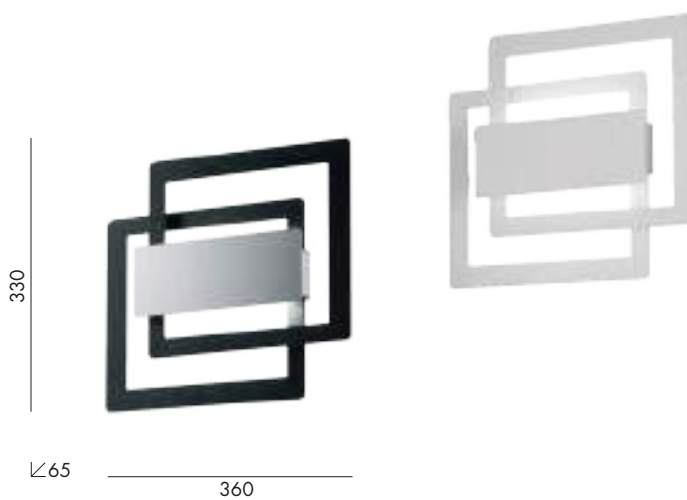

**EDI001**

LED 2x4,5W  
3000K 1400 lm



**EDI002**

R7s117 1x120W max



⊕ ⚡ IP20 CE



# MOODY



Lampada da parete biemissione, composta da due elementi in metallo sovrapposti. Disponibile in versione tutta bianca o nera con parte superiore in acciaio inox, con sorgente LED integrata (3000K) o con attacco R7s che consente di montare lampadina LED.

Direct and indirect light wall lamp, composed of two overlapping metal bands. Available in total white finish or black finish (with upper part in stainless steel), with LED integrated source (3000K) or with R7s lamp holder that allows mounting LED lamp.

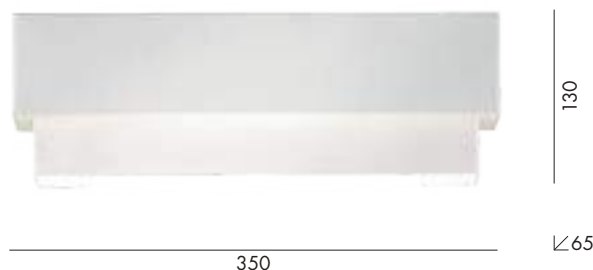

## MOO001

LED 2x4,5W  
3000K 1400 lm



## MOO002

R7s117 1x120W max



⊕ ⚡ IP20 CE







# MELBA



Lampada da parete biemissione dalla linea essenziale. Struttura in alluminio verniciato, proposta in finitura bianca e ottone spazzolato. Disponibile con sorgente LED integrata (3000K) o con attacco R7s che consente di montare lampadina LED.

Wall direct and indirect lamp, of essential shape. Painted aluminium body, available in white or brushed brass finish. Available with LED integrated source (3000K) or with R7s lamp holder that allows mounting LED lamp.



**MEB002**

LED 6W  
3000K 600 lm



**MEB001**

R7s78 1x80W max



⊕ ⚡ IP20 CE





# ARIAL



Lampada da parete biemissione con attacco R7s che consente di montare lampadina LED. Elegante design con struttura portante in metallo nichelato spazzolato (abbinato a fascia in foglia argento) o in metallo nero (abbinato a foglia oro).

Wall lamp with direct-indirect light with R7s lamp holder (that allows mounting LED lamp) enhanced by an elegant design. Brushed nickel-plated metal structure (with central part in silver leaf) or black metal structure (with central part in gold leaf).





130

300

∠80

**A.1664**

R7s117 1x100W max



⊕ ⊖ IP20 CE

ARG

ORO



# MYRIAD



Lampada da parete biemissione dal profilo stondato in metallo laccato bianco opaco. Cablata con attacco R7s che consente di montare lampadina a LED. Chiusura inferiore e superiore in vetro temperato a copertura della fonte luminosa e per una migliore diffusione della luce.

Direct and indirect wall lamp with rounded shape in matt white lacquered metal. R7s lamp holder that allows mounting LED lamp. Bottom and top cover in tempered glass to hide the light source and for optimal light diffusion.

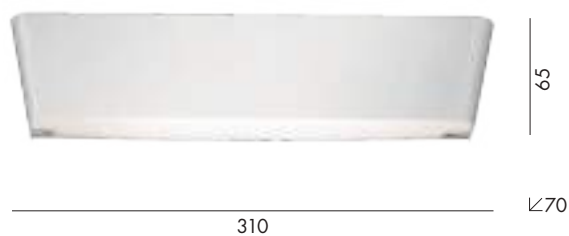

**MYR001B**

R7s117 1x120W max



⊕ ⊖ IP20 CE

**custom**  
made

Personalizzabile nella colorazione della struttura in metallo.  
Colour of the metal body available upon request.



ORO ARG RA

**custom**  
made

MADE IN  
MILANO





# SAND



Lampada da parete biemissione disponibile in tre misure e due finiture (bianco e nichel opaco). Proposta con sorgente LED integrata (2700K) o con attacco R7s che consente di montare lampadina LED. Struttura in metallo, schermi diffusori in vetro a protezione della fonte luminosa.

Direct and indirect wall lamp, available in three sizes and two finishes (white and matt nickel). Available with LED integrated source (2700K) or with R7s lamp holder that allows mounting LED lamp. Metal structure, glass diffusers to protect the light source.

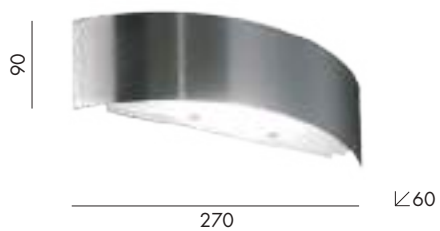

**SAD001**

R7s78 1x80W max



⊕ ⚡ IP20 CE



**SAD004**

LED 13,5W  
2700K 1250 lm



**SAD002**

R7s117 1x120W max



⊕ ⚡ IP20 CE



**SAD005**

LED 13,5W  
2700K 1250 lm



**SAD003**

R7s117 1x120W max



⊕ ⚡ IP20 CE





# AUSTIN



Lampada da parete in vetro, proposta in versione bianca satinata, foglia oro e foglia argento. Disponibile in diverse misure e relative potenze, con LED integrato (2700K) o con attacco E27 che consente di montare lampadina LED.

Wall glass lamp, available in white satin finish, golden leaf and silver leaf. Available in different sizes and related powers, with integrated LED source (2700K) or with E27 lamp holder that allows mounting LED lamp.

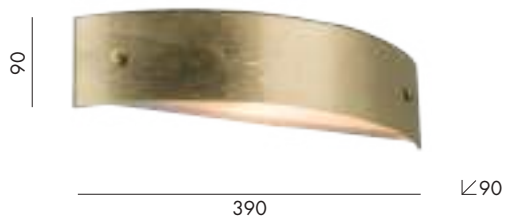

**AUS004**  
LED 13W  
2700K 1200 lm



**AUS001**  
E27 1x42W max



⊕ ⚡ IP20 CE



**AUS005**  
LED 26W  
2700K 2500 lm



**AUS002**  
E27 2x42W max



⊕ ⚡ IP20 CE

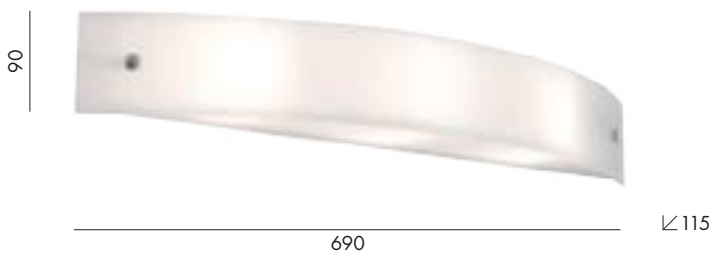
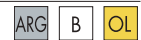

**AUS006**  
LED 26W  
2700K 2500 lm



**AUS003**  
E27 3x42W max



⊕ ⚡ IP20 CE





# DAVID



Lampada da parete biemissione; struttura in gesso, disponibile in tre finiture: bianco, foglia argento e foglia oro. La versione bianca consente la pittura del corpo in finitura colore a propria scelta. Cablata con attacco R7s che consente di montare lampadina LED.

Direct and indirect light wall lamp; plaster structure, available in three finishes: white, silver leaf and gold leaf. White version allows the customer to paint the product in the desired colour. R7s lamp holder that allows mounting LED lamp.



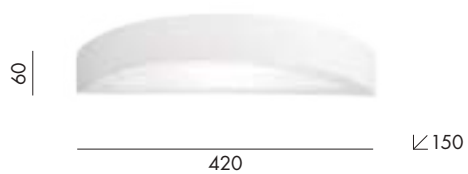

**A.4369**

R7s117 1x120W max

⊕ ⏚ IP20 CE

B ARG OL



**A.4370**

R7s117 1x120W max

⊕ ⏚ IP20 CE

B ARG OL



**A.4371**

R7s117 2x80W max

⊕ ⏚ IP20 CE

B ARG OL



versione bianca verniciabile in finitura colore a scelta  
white version paint the plaster body surface as desired



# DRIVE



Lampada da terra a luce indiretta con attacco R7s (che consente di montare lampadine LED) con struttura in metallo laccato disponibile in finitura bianca, grigia e nera. Proposta in due versioni: con un portalampada, con riflettore orientabile e regolabile in altezza, cavo di alimentazione in tinta (trasparente nella finitura grigia); con due portalampada, con maggiore efficienza luminosa, riflettore fisso e cavo di alimentazione integrato nella struttura.

Indirect light floor lamp with R7s lamp holder, that allows mounting LED lamp, with lacquered metal structure, available in white, grey and black finishes. Available in two versions: with one lamp holder, with reflector adjustable on the horizontal and vertical axes, power cable in the same colour (transparent for grey finish); with two lamp holders, more light efficiency, fixed reflector and power cable integrated in the luminaire.



1800

Ø 240

**DR1001**

R7s117 1x160W max



⊕ ⊖ IP20 CE

B

GR

N



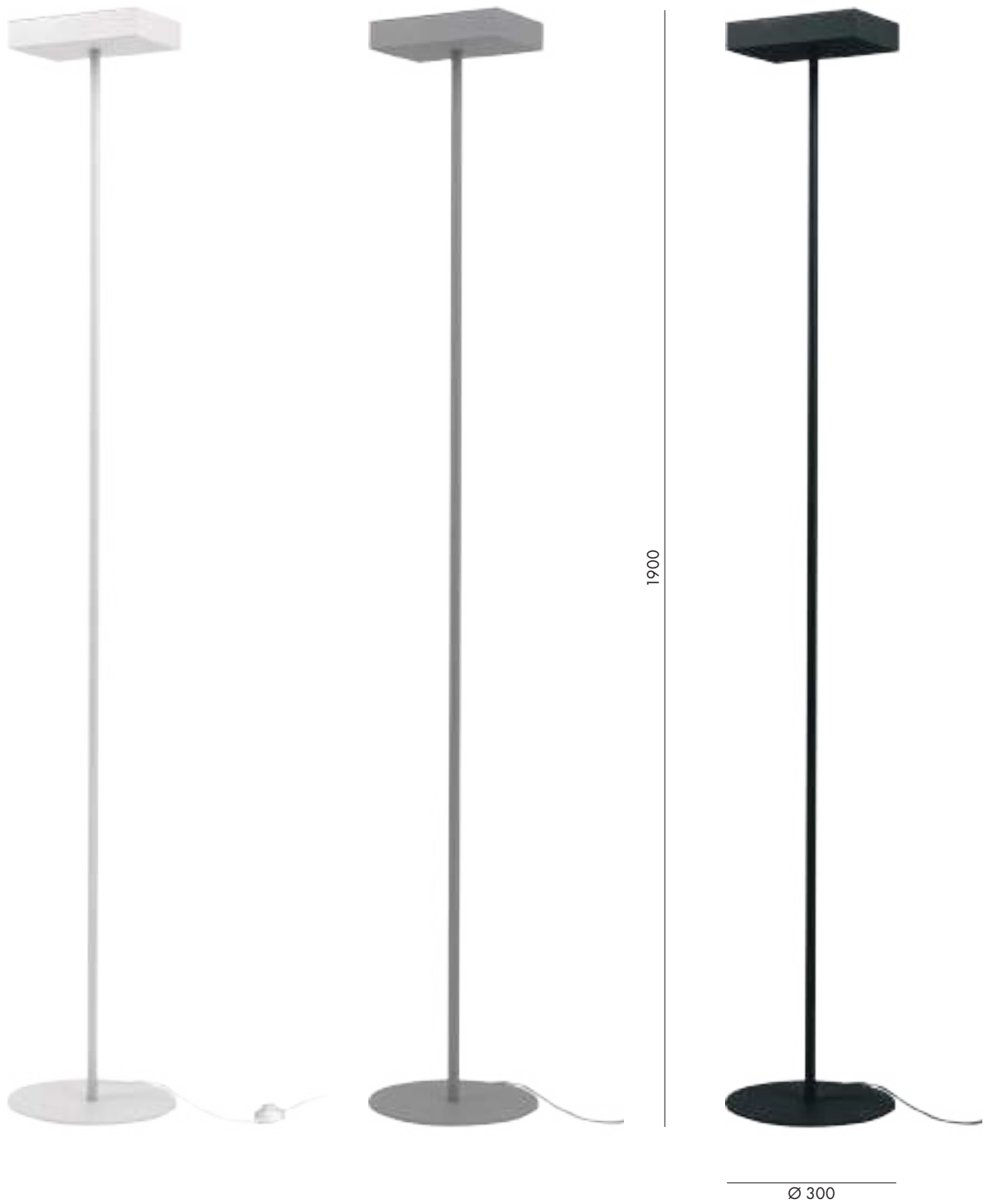

**DR1002**

R7s117 2x160W max



⊕ ⚡ IP20 CE

B

GR

N



# GRIP



Lampada da terra telescopica ad arco in metallo cromato, con base in marmo e diffusore in metacrilato. Proposta nella versione a luce diretta (attacco E27, finitura bianca o cromo) o a luce diretta e indiretta (attacco R7s, finitura cromo). Nella versione biemissione il diffusore è orientabile e ha un vetro satinato che permette l'emissione di luce verso il basso.

Arc-shaped telescopic floor lamp in chrome metal, with marble base and methacrylate diffuser. Available in direct light version (E27 lamp holder, white and chrome finishes) and in direct and indirect light version (R7s lamp holder, chrome finish). In the direct and indirect version the indirect light emission is possible thanks to a satin glass diffuser.



MADE IN  
MILANO

**T.2135**

E27 1x75W max



⊕ ⚡ IP20 CE Ⓢ



Ø 400

1750

2300

**T.2133-CR**

R7s117 1x240W max



⊕ ⚡ IP20 CE Ⓢ



Ø 400

2000

2000



# GEORGIA



Lampada con spot orientabili da parete e a soffitto con sorgente LED integrata (3000K); struttura in metallo verniciato di colore bianco. Prodotto dal design moderno e dalle dimensioni ridotte, viene proposto nella versione singola, da due o da tre elementi, ideale per l'installazione in bagni e luoghi di passaggio.

Wall and ceiling lamp with adjustable LED spotlight (3000K) in white painted metal. Lamp enhanced by a modern design and small size available in the single version or with two or three elements; it is suitable for installation in bathrooms and hallways.



**GEO001**

LED 6W  
3000K 540 lm

□ ▽ IP20 CE



**GEO002**

LED 2x6W  
3000K 1080 lm

□ ▽ IP20 CE



**GEO003**

LED 3x6W  
3000K 1620 lm

□ ▽ IP20 CE





# BENOIT



Lampada da parete e a soffitto in metallo cromato o in finitura nera con spot orientabili. Vetro in cristallo temperato a copertura della fonte luminosa, attacco GU10 che consente di montare lampadina LED. Prodotto proposto nella versione singola, da due o da tre elementi, ideale per l'installazione in bagni (IP44) e luoghi di passaggio.

Wall and ceiling lamp in chrome metal or in black finish, with adjustable spotlights. Tempered crystal glass to cover the light source with GU10 lamp holder to fit a LED lamp. Available in the single version or with two or three elements; it is suitable for installation in bathrooms (IP44) and hallways.

∠130



**BEO001**

GU10 1x40W max



⊕ ⚡ IP44 CE



∠140

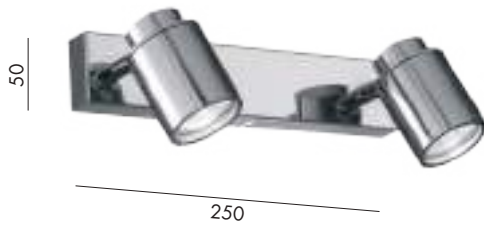

**BEO002**

GU10 2x40W max



⊕ ⚡ IP44 CE



∠140



**BEO003**

GU10 3x40W max



⊕ ⚡ IP44 CE



Ø200

∠140



**BEO004**

GU10 3x40W max



⊕ ⚡ IP44 CE





# BARNEY



Lampada da parete e a soffitto in metallo verniciato bianco, con spot orientabili. Vetro in cristallo temperato a copertura della fonte luminosa, attacco GU10 che consente di montare lampadina LED. Prodotto proposto nella versione singola, da due o da tre elementi, ideale per l'installazione in bagni (IP44) o luoghi di passaggio.

Wall and ceiling lamp in metal painted in white finish, with adjustable spotlights. Tempered crystal glass to cover the light source, with GU10 lamp holder to fit LED lamp. Available in the single version or with two or three elements; it is suitable for installation in bathrooms (IP44) and hallways.

∠130



**BAR001**

GU10 1x40W max



⊕ ∇ IP44 CE

∠140



**BAR002**

GU10 2x40W max



⊕ ∇ IP44 CE

∠140



**BAR003**

GU10 3x40W max



⊕ ∇ IP44 CE

∅200



∠140

**BAR004**

GU10 3x40W max



⊕ ∇ IP44 CE



# TOM

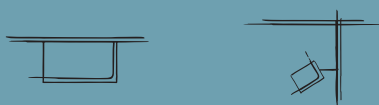

Lampada da parete e a soffitto con spot orientabili in metallo laccato (finiture bianco e nero). Disponibile in versione singola o da 3 elementi. Attacco E27 con lampadina a vista che consente all'utente di montare una lampadina a sua scelta, personalizzando ulteriormente il prodotto.

Wall and ceiling lamp with adjustable spotlights in lacquered metal (white and black finish). Available in single version or with three elements. E27 lamp holder with visible lamp, that allows the user to mount a light bulb of his choice and further personalize the product.

MADE IN  
MILANO



Ø80

∟180

## A.1710

E27 1x75W max



⊕ ⊖ IP20 CE



950

∟180

## 1710-3

E27 3x75W max



⊕ ⊖ IP20 CE



Ø 380



∟230

## 1710

E27 3x75W max



⊕ ⊖ IP20 CE





# ELLIS



Lampada da soffitto e a parete in alluminio con attacco E27 con lampadina a vista che consente all'utente di montare una lampadina a sua scelta, personalizzando ulteriormente il prodotto. Disponibile in cinque finiture (bianco, cromo, grigio, nero e oro lucido) e tre misure.

Ceiling and wall lamp in aluminium with E27 lamp holder with visible lamp, that allows the user to mount a light bulb of his choice and further personalize the product. Available in five finishes (white, chrome, grey, black and polished gold) and three sizes.

MADE IN  
MILANO

Ø 150



∟150

**1669-15**

E27 1x75W max



□ ▽ IP20 CE

B

CR

GR

N

OL

Ø 250



∟180

**1669-25**

E27 1x75W max



□ ▽ IP20 CE

B

CR

GR

N

OL

Ø 350



∟250

**1669-35**

E27 1x75W max



□ ▽ IP20 CE

B

CR

GR

N

OL





# PLAYA



Lampada a soffitto e da parete in vetro extra chiaro temperato lucido, dalla particolare forma geometrica. Struttura in metallo verniciato bianco. Disponibile in tre dimensioni e relative potenze e in finiture: bianco satinato, foglia oro e foglia argento. Cablata con attacco E27 che consente di montare lampadina LED.

Wall and ceiling lamp in polished tempered extra-clear glass characterised by a peculiar geometric shape. Structure in white painted metal. Available in three sizes and related powers and in three finishes: satin white, gold leaf and silver leaf. E27 lamp holder that allows mounting LED lamp.

**PLA001**

E27 1x75W max



⊕ ⊖ IP20 CE

SAT

ARG

OR



240

350

∟75

**PLA002**

E27 2x75W max



⊕ ⊖ IP20 CE

SAT

ARG

OR



360

450

∟75

**PLA003**

E27 3x75W max



⊕ ⊖ IP20 CE

SAT

ARG

OR



480

600

∟75



esempio di personalizzazione  
 customization example



Personalizzabile nella colorazione del vetro.  
 Glass colours available upon request.





# WESS



Lampada a soffitto e da parete in vetro extrachiaro lucido temperato con bordo colorato di bianco o grigio e particolari cromati. Cablata con attacco E27 che consente di montare lampadina LED.

Wall and ceiling lamp in tempered polished extra-clear glass with edge in white or grey colour and chrome details. E27 lamp holder that allows mounting LED lamp.

∟70

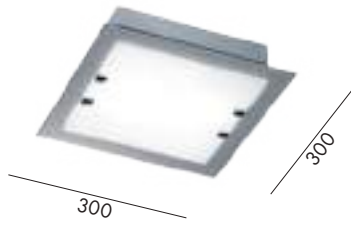

**WES001**

E27 2x75W max



⊕ ▽ IP20 CE



∟70



**WES002**

E27 4x75W max



⊕ ▽ IP20 CE



∟70

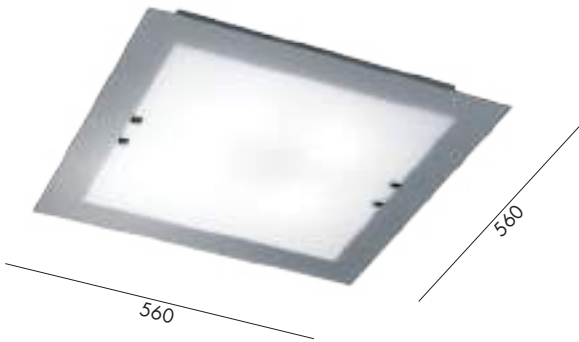

**WES003**

E27 4x75W max



⊕ ▽ IP20 CE



∟70



**WES004**

E27 1x75W max



⊕ ▽ IP20 CE



∟70

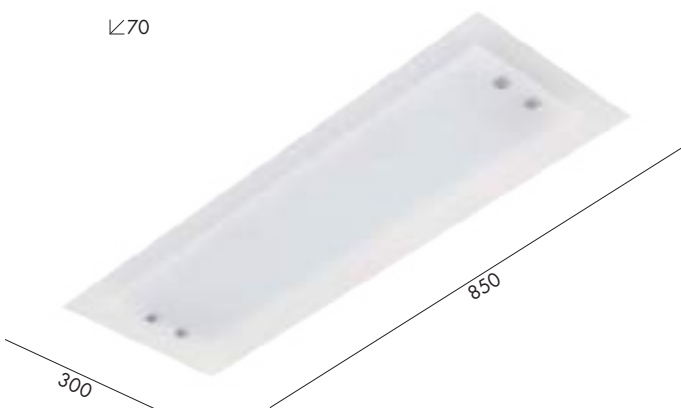

**WES005**

E27 4x75W max



⊕ ▽ IP20 CE





Personalizzabile nella colorazione del vetro.  
Glass colours available upon request.







# ASTRID



Lampada a soffitto e da parete disponibile in forma quadrata o rettangolare; struttura in metallo laccato disponibile in tre finiture (bianco, nero e arancione). Diffusore in doppio vetro temperato con dettagli cromati. Proposta nella versione LED (2700K) e con attacco tradizionale (E27) che consente di montare lampadina LED.

Square or rectangular shape wall and ceiling lamp with structure in lacquered metal, available in three finishes (white, black and orange). Double tempered glass diffuser with chrome details. Available with LED integrated source (2700K) or with traditional lamp holder (E27) that allows mounting LED lamp.

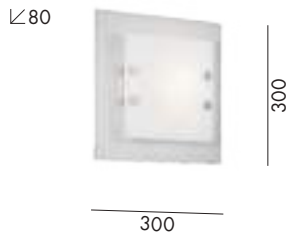

**2632-30-LED**

LED 13,5W  
2700K 1250 lm



**2632-30**

E27 1x75W max

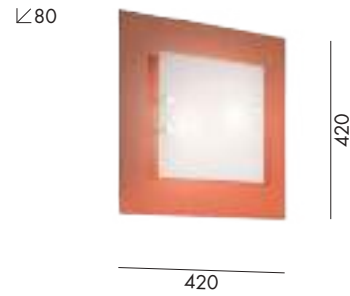

**2632-40-LED**

LED 17W  
2700K 1600 lm



**2632-40**

E27 2x75W max



**2632-55-LED**

LED 27W  
2700K 2500 lm



**2632-55**

E27 4x75W max



**A.2632-30**

E27 1x75W max



**A.2632-65-LED**

LED 27W  
2700K 2500 lm



**A.2632-65**

E27 2x75W max





Personalizzabile nella colorazione del vetro.  
Glass colours available upon request.

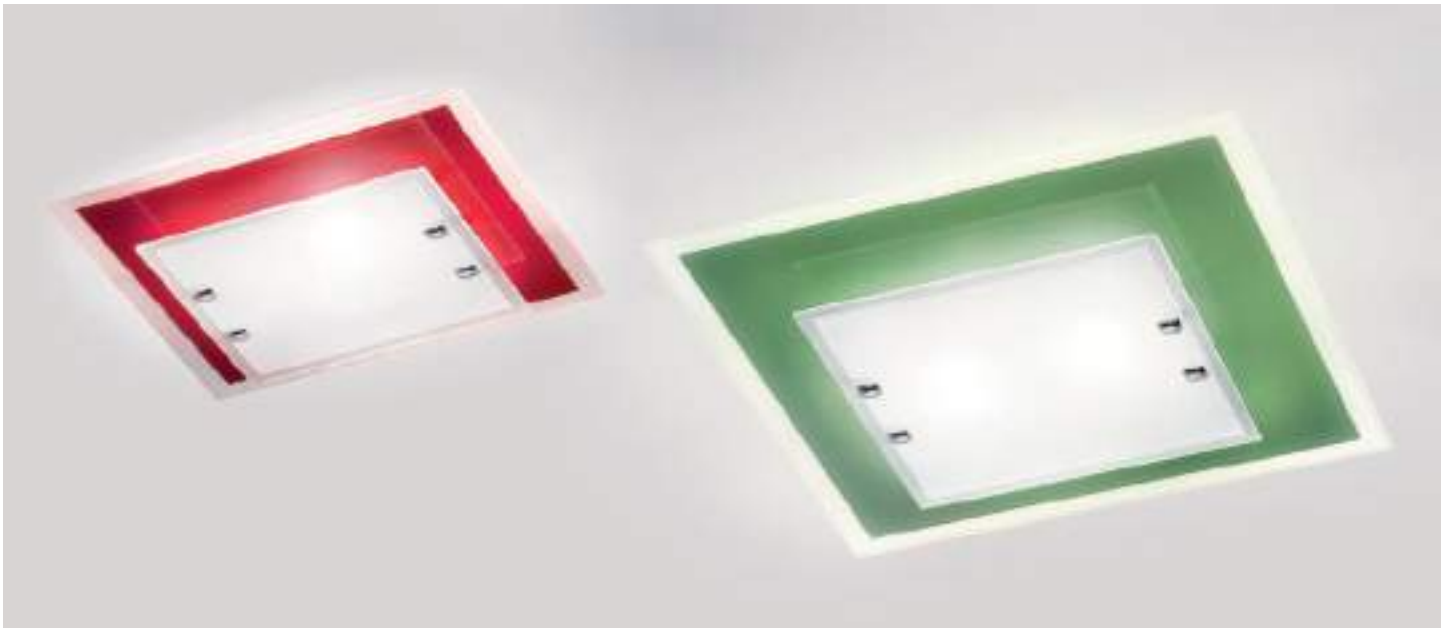



# BINNIE



Lampada da soffitto, a parete e da tavolo in vetro soffiato bianco satinato. Proposta nella versione quadrata o tonda, con attacco tradizionale o con sorgente LED integrata (2700K), in diverse misure e relative potenze. La versione tonda a LED (Ø 400mm) è corredata di sensore di presenza e crepuscolare a microonde.

Wall, ceiling and table lamp in satin white blown glass. Available in square or round shape, with traditional lamp holder or with integrated LED source (2700K), in different sizes and related powers. The round medium LED version (Ø 400mm) is equipped with twilight and motion microwave sensor.



MADE IN  
MILANO

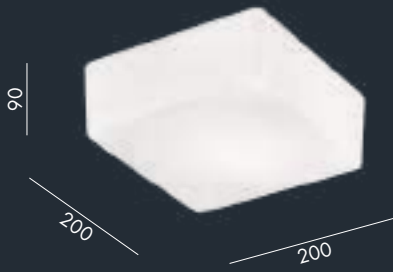

**10118-20-LED**

LED 10W  
2700K 1000 lm



**10118-20**

E27 1x75W max



⊕ ⊖ IP20 CE

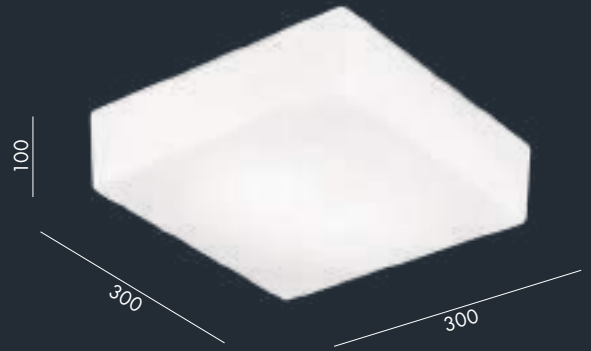

**10118-30-LED**

LED 17W  
2700K 1600 lm



**10118-30**

E27 1x75W max



⊕ ⊖ IP20 CE



**A.3400**

G9 1x33W max



⊕ ⊖ IP20 CE



**3400-10**

G9 1x33W max

⊕ ▽ IP20 CE

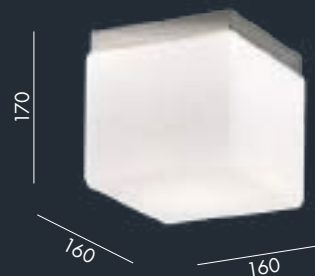

**3400-15-LED**

LED 10W

2700K 1000 lm

**3400-15**

E14 1x40W max

⊕ ▽ IP20 CE

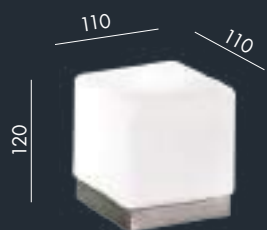

**P.3400-10**

G9 1x33W max

⊕ ▽ IP20 CE

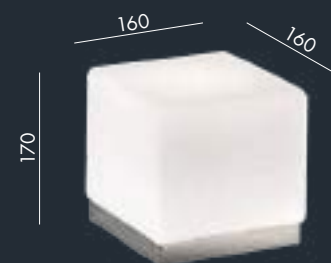

**P.3400-15**

E14 1x42W max

⊕ ▽ IP20 CE







**3619-30-LED**

LED 13W  
2700K 1200 lm



**3619-30**

E27 2x75W max



⊕ ▽ IP20 CE



Ø 300

∟90

**3619-40-LED**

LED 17W  
2700K 1600 lm



**3619-40-LED-S**

LED 15W  
2700K 1350 lm



sensore di presenza e crepuscolare  
twilight/motion microwave sensor

**3619-40**

E27 2x75W max



⊕ ▽ IP20 CE



Ø 400

∟100

**3619-50-LED**

LED 27W  
2700K 2500 lm



**3619-50**

E27 2x75W max



⊕ ▽ IP20 CE



Ø 500

∟110



# FOLKS



Lampada a soffitto a LED (3000K), con struttura in materiale plastico e diffusore in metacrilato che consente un'ottima diffusione della luce. Alimentatore integrato nella struttura della plafoniera che mantiene un'altezza contenuta, ideale per le abitazioni moderne. Disponibile in finitura bianca o nera, può essere installata in ambienti esterni (IP44).

LED ceiling lamp (3000K) with plastic structure and methacrylate diffuser for optimal light diffusion. LED driver integrated in the structure to reduce the height of the lamp, ideal for modern homes. Available in white or black finish, it can be installed in outdoor environments (IP44).



95 / 100

Ø 350 / 420

**FOL002**

LED 20W - Ø 350mm  
3000K 1600 lm



**FOL001**

LED 24W - Ø 420mm  
3000K 1920 lm



IP44 CE





# BALZAC



Lampada a soffitto con sorgente LED integrata (3000K), struttura in metallo verniciato (nei colori bianco e nero); diffusore in metacrilato bianco che consente un'ottima diffusione della luce. Alimentatore integrato nella struttura che mantiene un'altezza contenuta, ideale per le abitazioni moderne. Installabile anche in ambienti esterni (IP44).

Dimmable LED ceiling luminaire (3000K), painted metal structure (available in white and black colours); white methacrylate diffuser for optimal light diffusion. LED driver integrated in the structure to reduce the height of the lamp, ideal for modern homes. It can be installed in outdoor environments (IP44).



75

Ø 365

**BAZ001**

LED 40W

3000K 3000 lm



⊕ ⊖ IP44 CE





# LIND



Lampada a soffitto e da parete in vetro bianco temperato con filo cristallo. Struttura metallica bianca opaca con tagli laterali per un particolare effetto di luce sulla parete di installazione, viti e particolari cromati. Proposta in diverse dimensioni e relative potenze, nella versione a LED (2700K) e con attacco tradizionale (E27) che consente di montare lampadina LED.

Wall and ceiling lamp in white tempered glass with crystal bead. White metal structure with side slits with particular light effects on the installation surface, chrome screws and details. Available in different sizes and related powers, with LED integrated source (2700K) and with traditional lamp holder (E27) that allows mounting LED.

∟80



**10521-30-LED**



LED 17W - L.280 mm  
2700K 1600 lm

**10521-30**

E27 2x75W max - L.280 mm



⊕ ⊖ IP20 CE

**10521-45-LED**



LED 17W - L.440 mm  
2700K 1600 lm

**10521-45**

E27 4x75W max - L.440 mm



⊕ ⊖ IP20 CE

**10521-55-LED**



LED 26W - L.550 mm  
2700K 2400 lm

**10521-55**

E27 4x75W max - L.550 mm



⊕ ⊖ IP20 CE

∟80

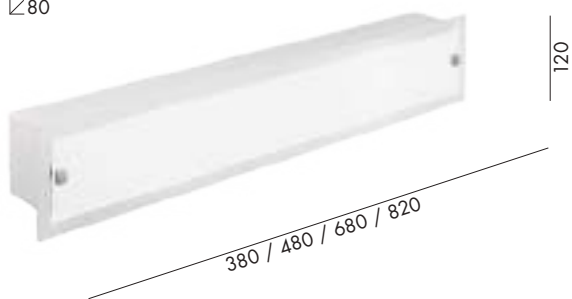

**A.10521-40-LED**



LED 13W - L.380 mm  
2700K 1200 lm

**A.10521-40**

E27 1x75W max - L.380 mm



⊕ ⊖ IP20 CE

**A.10521-50-LED**



LED 13W - L.480 mm  
2700K 1200 lm

**A.10521-50**

E27 2x75W max - L.480 mm



⊕ ⊖ IP20 CE

**A.10521-70-LED**



LED 26W - L.680 mm  
2700K 2400 lm

**A.10521-70**

E27 2x75W max - L.680 mm



⊕ ⊖ IP20 CE

**A.10521-80-LED**



LED 26W - L.820 mm  
2700K 2400 lm

**A.10521-80**

E27 3x75W max - L.820 mm



⊕ ⊖ IP20 CE





# MORI

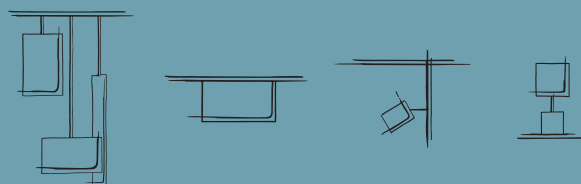

Lampada a sospensione, a soffitto, da parete e da tavolo in vetro curvo, satinato centralmente con bordo trasparente. Struttura in metallo verniciato, dettagli e finiture cromate. Proposta in versione con LED integrato (2700K) o con attacco tradizionale che consente di montare lampadina LED.

Pendant, wall, ceiling and table lamp with bent glass diffuser, satin at the centre with clear edge. Painted metal structure, chrome details and finishes. Available with LED integrated source (2700K) or with traditional lamp holder that allows mounting LED lamp.

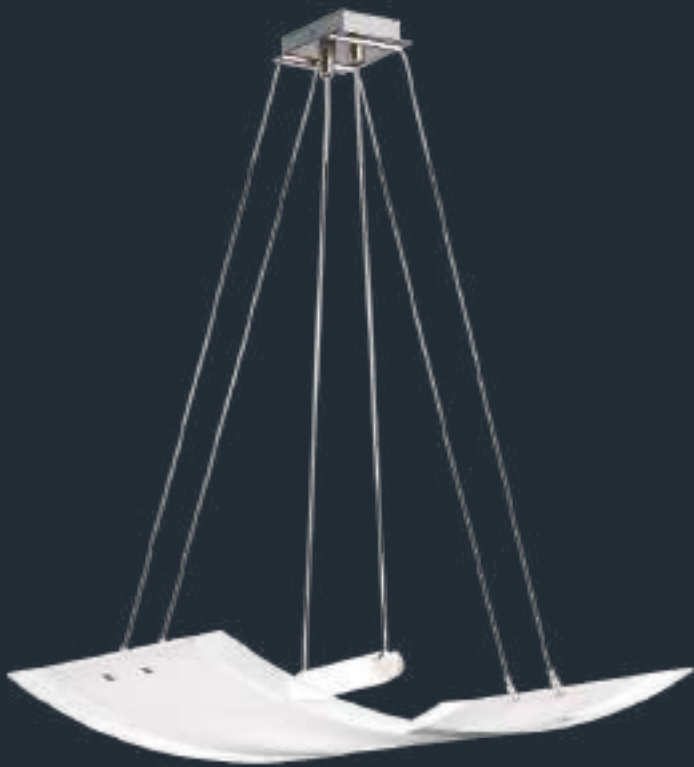

590 x 500

80

**8801**

R7s117 1x160W max

cavo cable L.max 1200mm

rosone ceiling rose 100x140x30mm



⊕ ⊖ IP20 CE



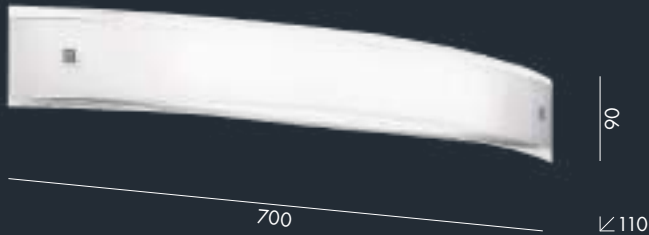

**A.8802-70-LED**

LED 26W  
2700K 2400 lm



⊕ ▽ IP20 CE



**A.8801-LED**

LED 10W  
2700K 1000 lm



**A.8801**

E27 1x75W max



⊕ ▽ IP20 CE



**8802-45-LED**

LED 26W - L.450 mm  
2700K 2400 lm



**8802-45**

E27 2x75W max - L.450 mm



**8802-60-LED**

LED 26W - L.590 mm  
2700K 2400 lm



**8802-60**

E27 3x75W max - L.590 mm



⊕ ▽ IP20 CE



**P.8801**

E14 1x40W max



⊕ ▽ IP20 CE



# TITO

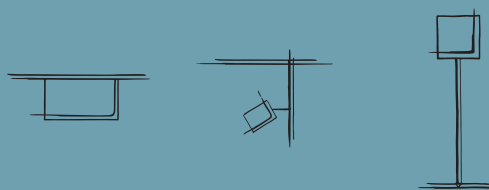

Lampada a soffitto, da parete e da terra con diffusore in vetro satinato curvato. Struttura rivestita in legno wengè. Versione da terra con base cromata.

Wall, floor and ceiling lamp with satin glass bent diffuser. Structure in wengè wood finish. Floor version with chrome base.

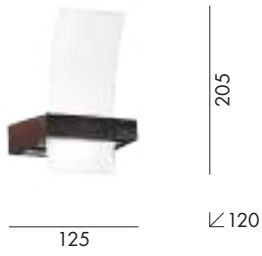

**A.8817-12**

G9 1x60W max

⊕ ▽ IP20 CE

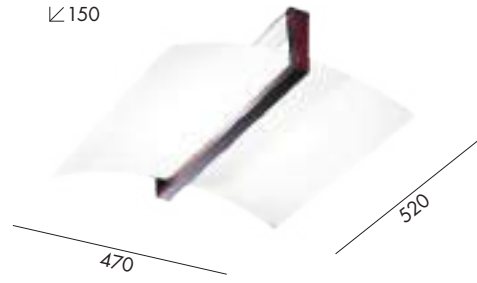

**8817**

R7s117 1x160W max

⊕ ▽ IP20 CE



**A.8817-23**

R7s117 1x80W max

⊕ ▽ IP20 CE



**T.8817**

R7s78 1x120W max

⊕ ▽ IP20 CE Ⓢ



**A.8817-45**

R7s117 1x120W max

⊕ ▽ IP20 CE





# ALLEN

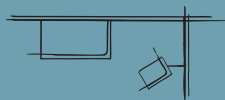

Lampada a soffitto e da parete orientabile di 360°; struttura in ottone cromato e diffusore in cristallo temperato con satinatura centrale che nasconde la fonte luminosa. Alta efficienza luminosa e luce diretta: il prodotto si presta all'installazione in ambienti particolari (con soffitto con travi in legno o con volte in mattoni).

360° adjustable wall and ceiling lamp; structure in chrome brass and diffuser in tempered crystal with central satin finish that hides the light source. Thanks to its high efficient direct light, the luminaire is suitable for installation in particular environments, such as those with wooden beam and brick vault ceilings.



**A.4700**

R7s78 1x120W max



⊕ ⊖ IP20 CE



**A.4701**

R7s117 1x160W max



⊕ ⊖ IP20 CE



**A.4702**

R7s117 1x160W max



⊕ ⊖ IP20 CE



# ACABA



Lampada da soffitto e a parete; struttura in metallo cromato, vetro lastra temperato (spessore 15mm) e diffusore in vetro pirex satinato a copertura della fonte luminosa. Versione a parete disponibile in tre misure e relative potenze.

Wall and ceiling lamp; chrome metal structure, tempered glass sheet diffuser (15mm thick) and satin pyrex glass that covers the light source. Wall version available in three sizes and related powers.



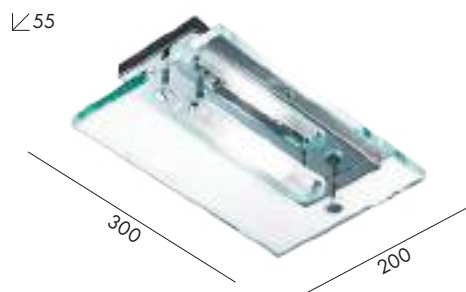

**8816**

R7s117 1x80W max



⊕ ⊖ IP20 CE

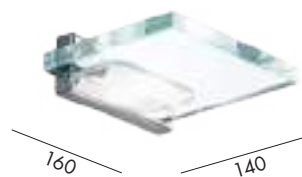

**A.8816-16**

G9 1x60W max



⊕ ⊖ IP20 CE

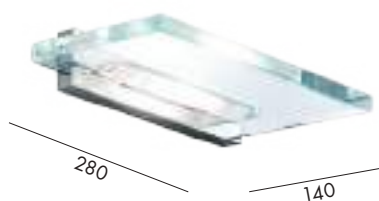

**A.8816-28**

R7s78 1x80W max



⊕ ⊖ IP20 CE

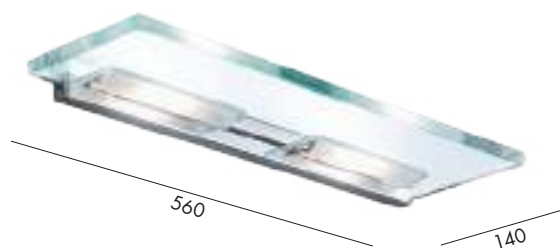

**A.8815**

R7s78 2x80W max



⊕ ⊖ IP20 CE

# DONNA



Lampada da soffitto e parete di forma quadrata con struttura in metallo e diffusore in vetro satinato, arricchito e decorato dal bordo in foglia oro e argento. Proposta in due dimensioni e relative potenze, con attacco E27 che consente di montare lampadina LED.

Ceiling and wall lamp in square shape. Metal structure with satin glass diffuser embellished by gold or silver leaf frame. Available in two sizes and related powers, with E27 lamp holder that allows mounting LED lamp.

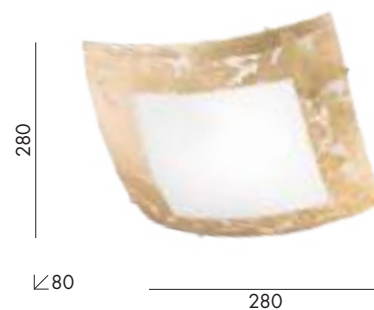

**1650-30**

E27 1x75W max



⊕ ⊖ IP20 CE

ARG ORO

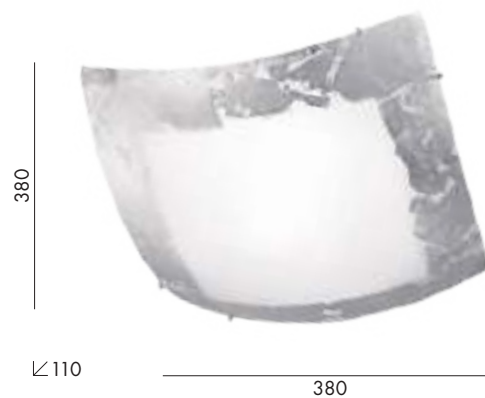

**1650-40**

E27 2x75W max



⊕ ⊖ IP20 CE

ARG ORO





# POM

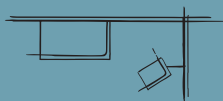

Lampada da soffitto e a parete a LED (3000K), installabile in interno o esterno (IP44). Struttura in alluminio verniciato bianco, diffusore in policarbonato opale, per un effetto di luce diffusa, con pratico attacco a baionetta. Disponibile in diversi diametri e relative potenze e nella versione con sensore di presenza a microonde (rilevazione movimento fino a 7mt di distanza con periodo di accensione regolabile tra 45 e 75 secondi).

Indoor and outdoor (IP44) wall and ceiling LED lamp (3000K). Aluminium body, white finished and opal PMMA diffuser for diffused light emission with easy-to-mount bayonet fixing. Available in three sizes and related powers and with microwave presence sensor (sensing distance up to 7mt, adjustable time setting from 45s up to 75s).



**POM001**

LED 14W  
3000K 875 lm



⊕ ⊖ IP44 CE



**POM003**

LED 18W  
3000K 1250 lm



**POM009**

LED 18W  
3000K 1250 lm  
sensore di presenza  
motion microwave sensor



⊕ ⊖ IP44 CE



**POM005**

LED 24W  
3000K 1900 lm



**POM011**

LED 24W  
3000K 1900 lm  
sensore di presenza  
motion microwave sensor



⊕ ⊖ IP44 CE



In presenza di persone, l'apparecchio si accende.  
When people stay, the luminaire switches on.



In assenza di persone, l'apparecchio si spegne, dopo un intervallo temporale impostato dall'utente (in fase di installazione dell'accessorio).  
When people are away, the luminaire switches off, after a set up time (value to set up during the installation of the device).



# PERLA



Lampada tonda da soffitto e da parete in vetro soffiato bianco latte che consente un'ottima diffusione della luce. Proposta in diverse misure e relative potenze, con LED integrato (2700K) o con attacco E27 che consente di montare lampadina LED. Versioni LED da 355mm e 450mm di diametro disponibili con sensore a microonde di presenza e crepuscolare.

Wall and ceiling round lamp in pure white blown glass for optimal light diffusion. Available in different sizes and related powers, with integrated LED source (2700K) or with E27 lamp holder that allows mounting LED lamp. LED version in 355mm and 450mm sizes available with twilight/motion microwave sensor.

**3618-25-LED**

LED 10W  
2700K 1000 lm



**3618-25**

E27 1x75W max



⊕ ▽ IP20 CE



Ø 250

∟90

**3618-35-LED**

LED 13W  
2700K 1200 lm



**3618-35-LED-S**

LED 15W  
2700K 1350 lm



sensore di presenza e crepuscolare  
twilight/motion microwave sensor

**3618-35**

E27 2x75W max



⊕ ▽ IP20 CE



Ø 355

∟130

**3618-45-LED**

LED 17W  
2700K 1600 lm



**3618-45-LED-S**

LED 15W  
2700K 1350 lm



sensore di presenza e crepuscolare  
twilight/motion microwave sensor

**3618-45**

E27 2x75W max



⊕ ▽ IP20 CE



Ø 450

∟140



**3618-55-LED**

LED 27W

2700K 2500 lm



**3618-55**

E27 2x75W max



⊕ ▽ IP20 CE



Ø 550

↙ 130

**A.3618**

E27 1x75W max



⊕ ▽ IP20 CE



155

270

↙ 135





# SIPLE

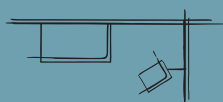

Lampada da soffitto e da parete con struttura quadrata in metallo verniciato disponibile in tre finiture (foglia argento, foglia oro e nichel opaco). Su due lati sono praticati dei tagli per la diffusione della luce e un effetto scenografico sulla superficie di installazione. Diffusore in vetro satinato, per un'ottima diffusione della luce. Disponibile in diverse misure e relative potenze, con attacco E14 che consente di montare lampadina LED.

Ceiling and wall lamp with square structure in painted metal, available in three finishes (silver and gold leaf and matt nickel). Slits are featured on two sides of the luminaire with scenographic light emission. Satin glass diffuser for a diffused light emission. Available in different sizes and related powers, with E14 lamp holder that allows mounting LED lamp.





300 / 400 / 500

300 / 400 / 500

∠55

**1645-30**   
E14 2x40W max - L.300 mm

**1645-40**   
E14 3x40W max - L.400 mm

**1645-50**   
E14 4x40W max - L.500 mm

⊕ ∇ IP20 CE   



# BRENDA



Lampada da soffitto composta da un vetro bianco satinato dalla forma sferica applicato su un vetro bianco con bordo trasparente dalla forma quadrata. Disponibile in diverse misure e relative potenze, con sorgente LED integrata (2700K) o con attacco E27 che consente di montare lampadina LED.

Ceiling lamp composed by a spherical satin glass mounting on a square structure made of white glass, with clear frame. Available in different sizes and related powers, with LED integrated source (2700K) or E27 lamp holder that allows mounting LED lamp.



**10501-35-LED**

LED 10W  
2700K 1000 lm



**10501-35**

E27 1x75W max



⊕ ⚡ IP20 CE



**10501-45-LED**

LED 13W  
2700K 1200 lm



**10501-45**

E27 2x75W max



⊕ ⚡ IP20 CE



compatibile con lampadine LED con tecnologia smart (pag. 730)  
suitable for smart LED light bulbs (pag. 730)



# SID



Lampada tonda a soffitto e da parete, con diffusore in vetro satinato; struttura in metallo laccato. Disponibile in diversi diametri e relative potenze, con attacco E27 che consente di montare lampadina LED.

Round ceiling and wall lamp with satin glass diffuser; lacquered metal structure. Available in different sizes and related powers, with E27 lamp holder that allows mounting LED lamp.

**1626-30**  
E27 2x75W max



⊕ ▽ IP20 CE



Ø 300

∟75

**1626-40**  
E27 2x75W max



⊕ ▽ IP20 CE



Ø 400

∟90

**1626-50**  
E27 3x75W max



⊕ ▽ IP20 CE



Ø 500

∟120





# SCRAT



Lampada a soffitto e da parete con struttura in metallo e vetro bianco satinato bombato. Disponibile nella versione tonda e quadrata, in diverse misure e relative potenze e in tre finiture (bianco, cromo e oro lucido). Disponibile con LED integrato (2700K) e con attacco standard che consente di montare lampadina LED.

Ceiling and wall lamp with metal structure and convex satin white glass. Available in round and square versions, in different sizes and related powers and in three finishes (white, chrome and polished gold). Available with integrated LED source (2700K) and with standard lamp holder that allows mounting LED lamp.

**10630-20-LED**

LED 10W  
2700K 1000 lm



**10630-20**

E14 1x40W max



⊕ ⊖ IP20 CE



**10630-30-LED**

LED 13W  
2700K 1200 lm



**10630-30**

E27 1x75W max



⊕ ⊖ IP20 CE



**10630-40-LED**

LED 17W  
2700K 1600 lm



**10630-40**

E27 2x75W max



⊕ ⊖ IP20 CE

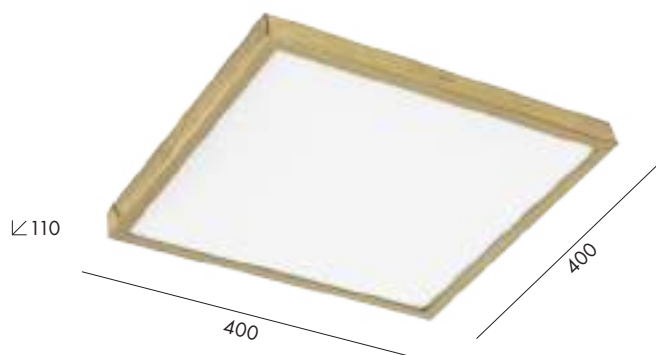

**10632-20-LED**

LED 10W  
2700K 1000 lm



**10632-20**

E14 1x40W max



⊕ ⊖ IP20 CE



210

∟70

**10632-30-LED**

LED 13W  
2700K 1200 lm



**10632-30**

E27 1x75W max



⊕ ⊖ IP20 CE



310

∟90

**10632-40-LED**

LED 17W  
2700K 1600 lm



**10632-40**

E27 2x75W max



⊕ ⊖ IP20 CE



410

∟110



# GOGOL

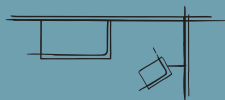

Lampada da soffitto e da parete dalla particolare forma asimmetrica, che si ottiene con due parti metalliche accoppiate sfalsate tra loro, disponibili nei colori bianco e nero. Vetro diffondente soffiato bianco satinato, finiture cromate. Disponibile in diverse misure e relative potenze, con attacco R7s e E27 che consentono di montare lampadina LED.

Wall and ceiling lamp with asymmetrical shape: two metal elements combined together asymmetrically, available in white and black finish. Satin white blown glass diffuser, chrome finishes. Available in different sizes and related powers, with R7s and E27 lamp holders that allow mounting LED lamp.



**GOG001NB**

R7s78 1x80W max



⊕ ⊖ IP20 CE



**GOG002NB**

E27 1x75W max



⊕ ⊖ IP20 CE

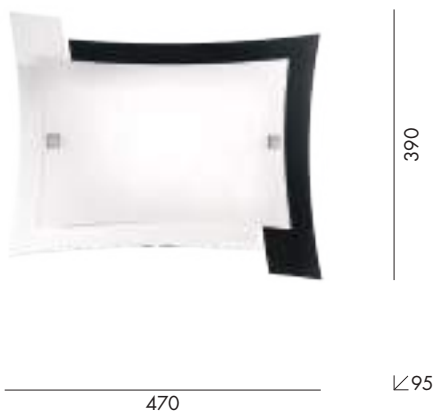

**GOG003NB**

E27 1x75W max



⊕ ⊖ IP20 CE



**GOG004NB**

E27 2x75W max



⊕ ⊖ IP20 CE



# ROMAN

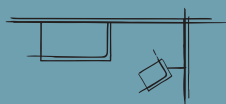

Lampada da soffitto e da parete con diffusore in vetro curvo satinato; struttura dell'apparecchio e particolari in metallo nichelato. Disponibile in diverse misure e relative potenze. Cablata con attacco R7s che consente di montare lampadina LED.

Ceiling and wall lamp with satin bent glass diffuser; structure and details are in nickel-plated metal. Available in different sizes and related powers. R7s lamp holder that allows mounting LED lamp.

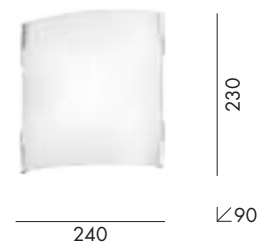

**5465-25**

R7s78 1x120W max



⊕ ▽ IP20 CE

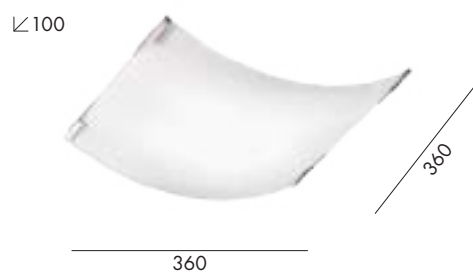

**5465-35**

R7s117 1x160W max



⊕ ▽ IP20 CE



**5465-45**

R7s117 1x160W max



⊕ ▽ IP20 CE



# JENNY



Lampada da soffitto e da parete con struttura in metallo laccato bianco e diffusore in cristallo serigrafato, particolari cromati. Disponibile in diverse misure e relative potenze. Cablata con attacco E27 che consente di montare lampadina LED.

Ceiling and wall lamp, structure in white lacquered metal with decorated crystal diffuser, chrome details. Available in different sizes and related powers. E27 lamp holder that allows mounting LED lamp.

MADE IN  
MILANO



**1678-30**  
E27 2x75W max - L.300 mm



**1678-40**  
E27 2x75W max - L.400 mm



⊕ ⊖ IP20 CE



**A.1678**  
E27 1x75W max



⊕ ⊖ IP20 CE

# PARK

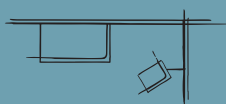

Lampada da soffitto e da parete dalla forma ovale; struttura in metallo verniciato grigio con particolari cromo, diffusore in vetro satinato, per un'ottima diffusione della luce. Disponibile in diverse misure e relative potenze, con attacco E27 che consente di montare lampadina LED.

Oval shape ceiling and wall lamp; grey painted metal structure with chrome details, satin bent glass diffuser, for a diffused light emission. Available in different sizes and related powers. E27 lamp holder that allows mounting LED lamp.



240 / 330

485 / 660

∠110

## 3230-50

E27 2x75W max - L.485 mm



## 3230-60

E27 4x75W max - L.660 mm



⊕ ⊖ IP20 CE







# MAGDA



Lampada da parete e da soffitto; struttura in metallo laccato e diffusore in vetro satinato con inserti colorati, disponibili in tre finiture: ambra, blu e cristallo. Disponibile in diverse misure e relative potenze, con attacco E27 che consente di montare lampadina LED.

Wall and ceiling lamp; lacquered metal structure and satin glass diffuser with decorative elements available in three finishes: amber, blue and crystal. Available in different sizes and related powers, with E27 lamp holder that allows mounting LED lamp.

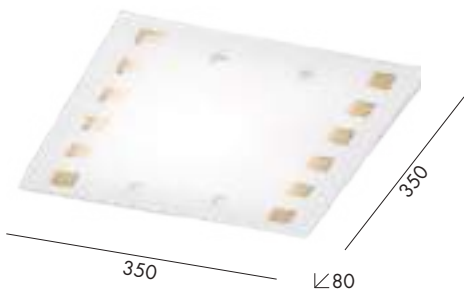

**1050-35**

E27 1x75W max

⊕ ⊖ IP20 CE AM BLU CRI

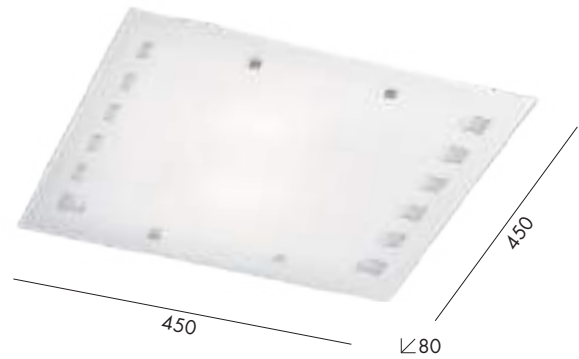

**1050-45**

E27 2x75W max

⊕ ⊖ IP20 CE AM BLU CRI

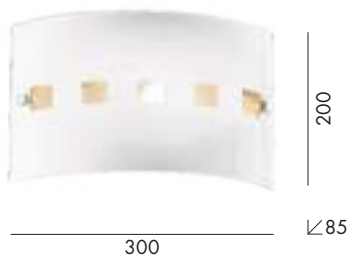

**A.1050-30**

E27 1x75W max

⊕ ⊖ IP20 CE AM BLU CRI

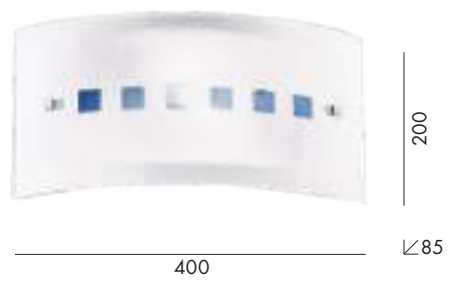

**A.1050-40**

E27 2x75W max

⊕ ⊖ IP20 CE AM BLU CRI





# YUCCA



Lampada da soffitto e da parete con supporto in metallo verniciato e diffusore in vetro soffiato decorato rigadin. Disponibile in due misure, cablata con attacco E27 che consente di montare lampadina LED.

Ceiling and wall lamp with painted metal support and diffuser in blown glass, "rigadin" style. Available in two sizes, with E27 lamp holder that allows mounting LED lamp.

MADE IN  
MURANO



Ø 285

∟ 120

**1639-25**

E27 2x75W max



⊕ ⊖ IP20 CE



Ø 370

∟ 130

**1639-35**

E27 2x75W max



⊕ ⊖ IP20 CE



Ø 300 / 410 / 515

∟90

**1052-30-CRI**

E27 2x75W max - Ø300 mm



**1052-40-CRI**

E27 2x75W max - Ø410 mm



**1052-50-CRI**

E27 3x75W max - Ø515 mm



⊕ ⊖ IP20 CE

# MAGÒ



Lampada da parete e da soffitto in vetro opale serigrafato con decori cristallo, particolari cromati. Disponibile in diverse misure e relative potenze. Cablata con attacco standard che consente di montare lampadina LED.

Wall and ceiling lamp in opal glass enhanced by decors in crystal finish; chrome details. Available in different sizes and related powers. Traditional lamp holder that allows mounting LED lamp.



300 / 400

200

∟90

**A.1052-30-CRI**

E14 2x40W max - L. 300 mm



**A.1052-40-CRI**

E27 2x75W max - L. 400 mm



⊕ ⊖ IP20 CE



# JOHN



Lampada da parete e a soffitto con struttura in metallo verniciato (nelle finiture bianco lucido, oro lucido e cromo) e diffusore in vetro serigrafato. Disponibile in diverse misure e relative potenze. Cablata con attacco E27 che consente di montare lampadina LED.

Wall and ceiling lamp with lacquered metal structure (in polished gold, polished white and chrome finishes) and decorated glass diffuser. Available in different sizes and related powers. E27 lamp holder that allows mounting LED lamp.

MADE IN MILANO



Ø 300 L75

**1654-30**

E27 1x75W max



⊕ ⊖ IP20 CE



Ø 390 L90

**1654-40**

E27 2x75W max



⊕ ⊖ IP20 CE



310 L80

**A.1654**

E27 1x75W max



⊕ ⊖ IP20 CE





# CALEB



Lampada da parete con diffusore in metacrilato opale satinato disponibile con o senza bordo trasparente. Struttura in metallo verniciato grigio. Prodotto cablato con attacco E27 che consente di montare lampadina LED.

Wall lamp with satin opal methacrylate diffuser available with or without transparent edge. Grey painted metal structure. E27 lamp holder that allows mounting LED lamp.

MADE IN  
MILANO



**A.3293**

E27 1x75W max

⊕ ⊖ IP20 CE



**A.3294**

E27 1x75W max

⊕ ⊖ IP20 CE





# SCILLA

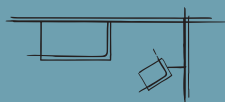



Lampada da parete e a soffitto con diffusore in metacrilato opale satinato, disponibile con bordo trasparente (codici con desinenza 3295 e 3297) o senza bordo trasparente (codici con desinenza 3296 e 3298). Proposto in forma squadrata o tondeggiante a onda; disponibile in diverse misure e relative potenze. Cablata con attacco E27 che consente di montare lampadina LED.

Ceiling and wall lamp with satin opal methacrylate diffuser, available with clear edge (3295 and 3297 codes) and without clear edge (3296 and 3298 codes). Available in square or wave-shape version, in different sizes and related powers. E27 lamp holder that allows mounting LED lamp.

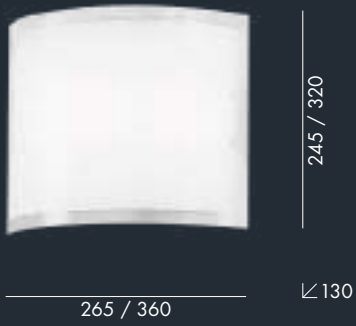





**A.3295-26**   
E27 1x75W max - L.265 mm

**A.3295-37**   
E27 2x75W max - L.360 mm

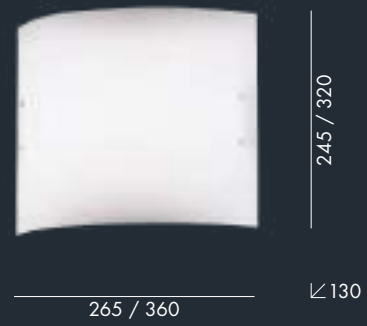
⊕ ▽ IP20 CE





**A.3296-26**   
E27 1x75W max - L.265 mm

**A.3296-37**   
E27 2x75W max - L.360 mm

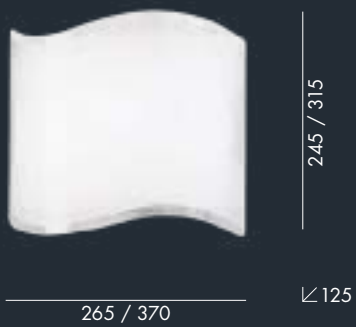
⊕ ▽ IP20 CE





**A.3297-26**   
E27 1x75W max - L.265 mm

**A.3297-37**   
E27 2x75W max - L.370 mm

⊕ ▽ IP20 CE



**A.3298-26**   
E27 1x75W max - L.265 mm

**A.3298-37**   
E27 2x75W max - L.370 mm

⊕ ▽ IP20 CE



# AMELIE



Lampada da parete con diffusore in metacrilato opale satinato dalla particolare forma ad onda, modellata sulla fonte luminosa. Prodotto cablato con attacco E27 che consente di montare lampadina LED.

Wall lamp with satin opal methacrylate diffuser enhanced by the unique wave-shape, moulded on the light source. E27 lamp holder that allows mounting LED lamp.



**A.3290**  
E27 1x75W max

⊕ ⊖ IP20 CE

MADE IN  
MILANO



# ALBATROS

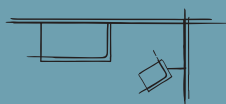

Lampade da parete e a soffitto in vetro extrachiaro bianco lucido, con bordo in cristallo trasparente. Montatura in metallo verniciato bianco, particolari cromati. Attacco E27 che consente di montare lampadina LED.

Ceiling and wall lamp in polished white extra - clear glass, edge in clear crystal. White painted metal frame, chrome details. E27 lamp holder that allows mounting LED lamp.

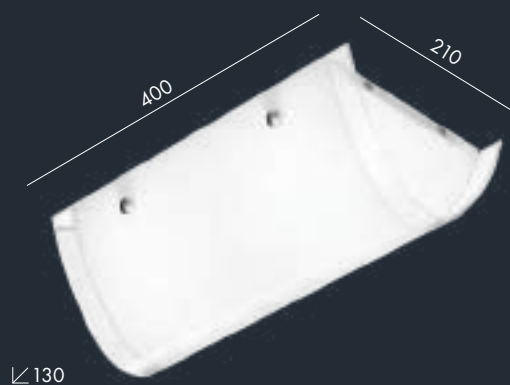

**ALB001**

E27 2x75W max



⊕ ⊖ IP20 CE

MADE IN  
MILANO



# BOND

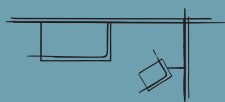

Lampada da parete o a soffitto disponibile in tre misure e relative potenze; struttura e particolari in metallo nichelato con diffusore in vetro satinato. Proposta con sorgente LED integrata (2700K) o con attacco E27 che consente di montare lampadina LED.

Wall or ceiling lamp available in three different sizes and related powers; structure and details in nickel-plated metal with satin glass diffuser. Available with LED integrated source (2700K) or with E27 lamp holder that allows mounting LED lamp.



**A.3625-20-B-LED**

LED 10W  
2700K 1000 lm



**A.3625-20-B**

E27 1x75W max



⊕ ▽ IP20 CE



**A.3625-35-B-LED**

LED 13,5W  
2700K 1250 lm



**A.3625-35-B**

E27 2x75W max



⊕ ▽ IP20 CE

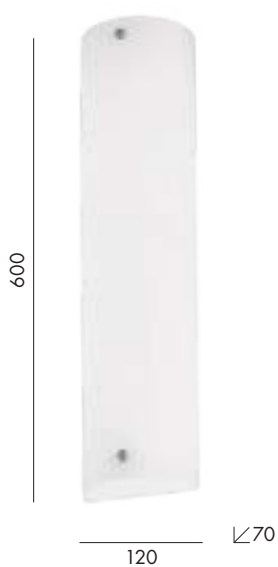

**A.3625-60-B-LED**

LED 26W  
2700K 2400 lm



**A.3625-60-B**

E27 3x75W max



⊕ ▽ IP20 CE



# KAWA



Lampade da parete (inclusa versione angolare), con struttura in metallo e diffusore in vetro soffiato satinato, disponibile nei colori bianco o ambra. Cablata con attacco E27 che consente di montare lampadina LED.

Wall lamp (including the corner version), with metal structure and satin blown glass diffuser, available in white or amber colour. E27 lamp holder that allows mounting LED lamp.

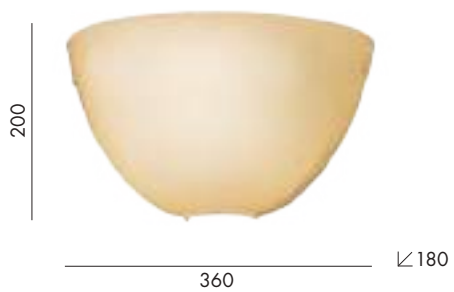

**A.6306**

E27 2x75W max



⊕ ⊖ IP20 CE



**A.6307**

E27 1x75W max



⊕ ⊖ IP20 CE



versione angolare  
corner version



**A.6308**

E27 1x75W max



⊕ ⊖ IP20 CE





# CURTIS



Lampada da parete di dimensioni molto ridotte; struttura in metallo e diffusore in vetro satinato per un'ottima diffusione della luce. Cablata con attacco E27 che consente di montare lampadina LED.

Wall lamp of very small size; metal structure and satin glass diffuser for diffused light emission. E27 lamp holder that allows mounting LED lamp.



**A.3342-15**  
E27 1x75W max



⊕ ▽ IP20 CE



**A.3342-30**  
E27 1x75W max



⊕ ▽ IP20 CE



new



# CHANDRA



Lampada da tavolo orientabile, con attacco E14 che consente di montare lampadina LED. Struttura in metallo verniciato a polveri bianco e nero, con interno bianco per una migliore diffusione della luce. Il diffusore è collegato allo stelo da un inserto cromato, ha una rotazione orizzontale di 300° e verticale di 90° per assicurare il migliore flusso luminoso in ogni situazione. Ideale per la zona notte.

Adjustable table lamp with E14 lamp holder that allows mounting LED lamp. White and black powder-coated metal structure, with interior in white finish for a better light diffusion. The diffuser, fixed to the stem by a chrome-plated element, has a horizontal rotation of 300° and a vertical rotation of 90° to ensure the best light emission in every situation. Ideal for the bedroom.



250

Ø 130

**CHN001**

E14 1x40W max



⊕ ⊖ IP20 CE

B

N





Dimensioni Dimensions  
 Ø 165 mm - H. 1070 mm

# HOLE



Lampada da tavolo con fissaggio a morsetto o con base, con attacco a parete in metallo laccato. Snodo tra i due bracci e rotazione del diffusore, su cui è posta l'accensione. Disponibile in tre finiture (bianco, grigio e nero). Da ordinare come accessorio griglia di protezione per utilizzo in luoghi di lavoro; cablata con attacco E27 che consente di montare lampadina LED.

Table lamp with clamp fastening or base or with wall support in lacquered metal. Two cantilevered arms and adjustment of the diffuser featuring the switch. Available in three finishes (white, grey and black). Protection grid to be ordered as accessory (suitable for work places); E27 lamp holder that allows mounting LED lamp.

## M.40

E27 1x75W max  
 braccio bracket L.max 1070mm



⊕ ⊖ IP20 CE

B GR N

## accessori / accessories



**MT.41**  
 attacco a parete /  
 wall support

B GR N



**MT.42**  
 griglia di protezione  
 protection grid



Ø 256

**MT.40**  
 base base

B GR N

MADE IN  
 MILANO

restyle



# ACE



Lampada da tavolo a LED (6500K) con fissaggio a morsetto, struttura in metallo laccato. Snodo tra i due bracci e rotazione del diffusore, su cui è posta l'accensione. Dotata di lente di ingrandimento (Ø 120 mm) a 3 diottrie. Disponibile in due finiture: bianco e grigio.

LED table lamp (6500) with clamp fastening, structure in lacquered metal. Cantilevered arms and adjustment of the diffuser featuring the switch. Equipped with 3 dioptre magnifying lens (Ø 120 mm). Available in two finishes: white and grey.

MADE IN MILANO



**M.32**

LED 9,5W

6500K 1000 lm

braccio bracket L.max 1200mm

⊕ ⊖ IP20 CE

B GR





# KALERI



Lampada a sospensione e da parete con struttura in metallo cromato e diffusore in vetro lastra verniciato lucido. Disponibile in tre finiture (arancio, bianco e rosso), sospensione proposta in tre misure e con cavo in tinta con il corpo lampada.

Wall and pendant lamp with chrome metal structure and diffuser in polished sheet glass. Available in three finishes (orange, white and red), suspended version available in three sizes with cable in the same colour of the body.



**KAL001**

E27 1x75W max  
 cavo cable L.max 1000mm  
 rosone ceiling rose Ø100x40mm

⊕ ⊖ IP20 CE B AR R

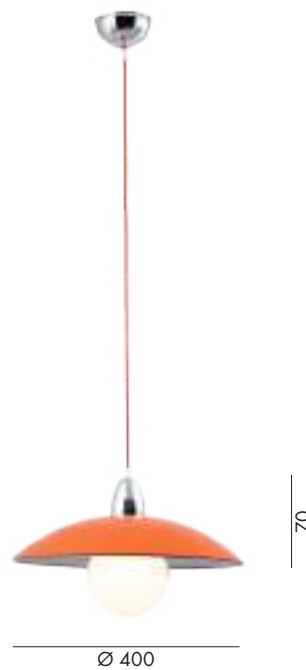

**KAL002**

E27 1x75W max  
 cavo cable L.max 1000mm  
 rosone ceiling rose Ø100x40mm

⊕ ⊖ IP20 CE B AR R



**KAL003**

E27 1x75W max  
 cavo cable L.max 1000mm  
 rosone ceiling rose Ø100x40mm

⊕ ⊖ IP20 CE B AR R



**KAL004**

E27 1x75W max

⊕ ⊖ IP20 CE B AR R





esempio di personalizzazione customization example



Personalizzabile nella colorazione del vetro.  
Glass colours available upon request.

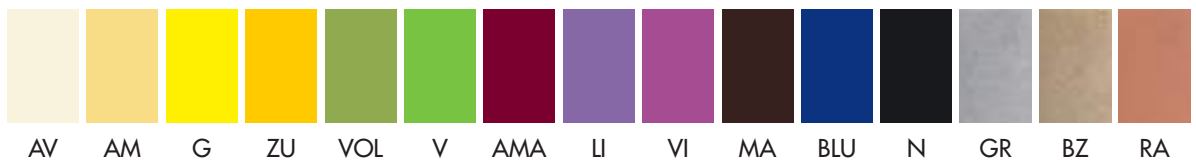



# INGRID

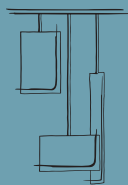

Lampada a sospensione e da parete in vetro satinato con decoro argento realizzato a mano. Struttura e finiture cromate. Sospensione disponibile in tre misure. Cablata con attacco E27 che consente di montare lampadina LED.

Pendant and wall lamp in satin glass with hand-made silver décor. Chrome structure and finishes. Pendant version available in three sizes. E27 lamp holder that allows mounting LED lamp.



MADE IN  
MILANO

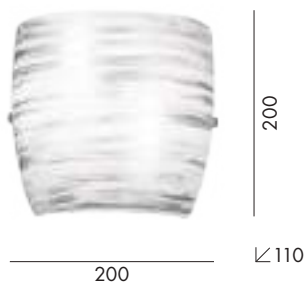

**A.10106-ARG**

E27 1x40W max

⊕ ▽ IP20 CE



**10106-20-ARG**

E27 1x75W max - Ø 200 mm

**10106-25-ARG**

E27 1x75W max - Ø 270 mm

**10106-35-ARG**

E27 3x75W max - Ø 350 mm

cavo cable L.max 1000mm  
rosone ceiling rose Ø 120x30mm

⊕ ▽ IP20 CE





# MILLA

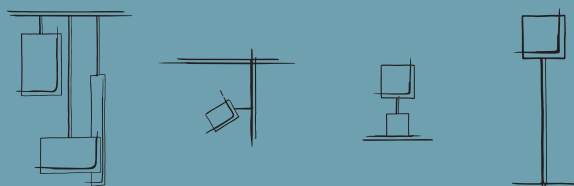

Lampada a sospensione, da parete, da tavolo e da terra in vetro soffiato bianco con eleganti molature eseguite a mano. Struttura e particolari in metallo cromato.

Pendant, wall, table and floor lamp in white blown glass with elegant hand-made engravings. Chrome metal structure and details.



MADE IN  
MILANO



**3424-B**

E27 1x75W max

cavo cable L.max 1200mm

rosone ceiling rose Ø 120x30mm

⊕ ⊖ IP20 CE



**P.3424-B**

G9 1x33W max

⊕ ⊖ IP20 CE





**A.3424-15-B**

G9 1x33W max

⊕ ▽ IP20 CE

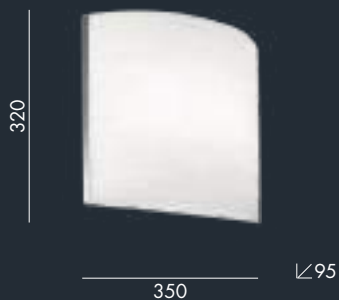

**A.3424-30-B**

E27 2x75W max

⊕ ▽ IP20 CE



**A.3425-B**

E27 1x75W max

⊕ ▽ IP20 CE

Ø 360

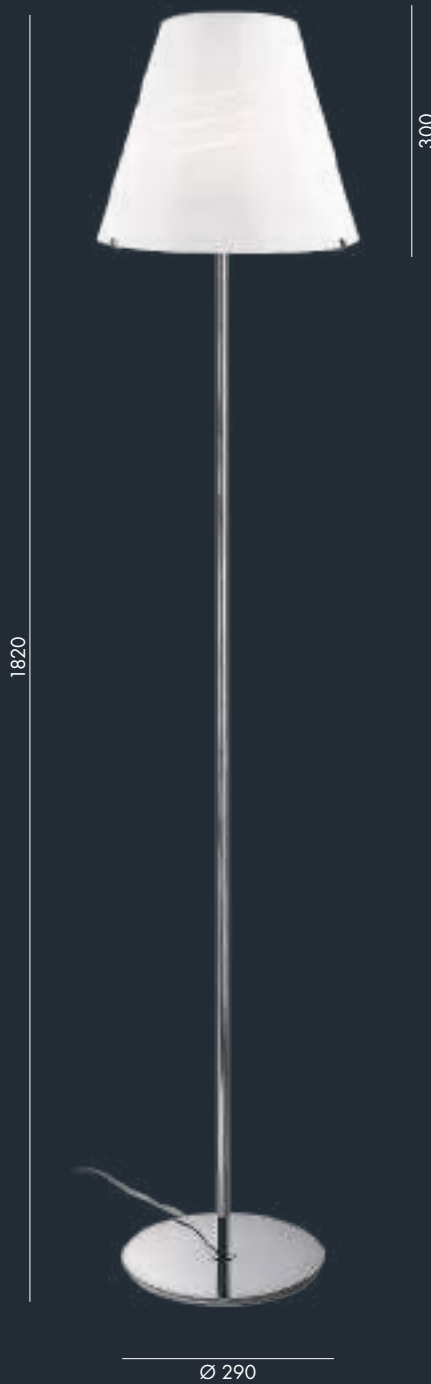

**T.3424-B**

E27 1x75W max

⊞ ▽ IP20 CE

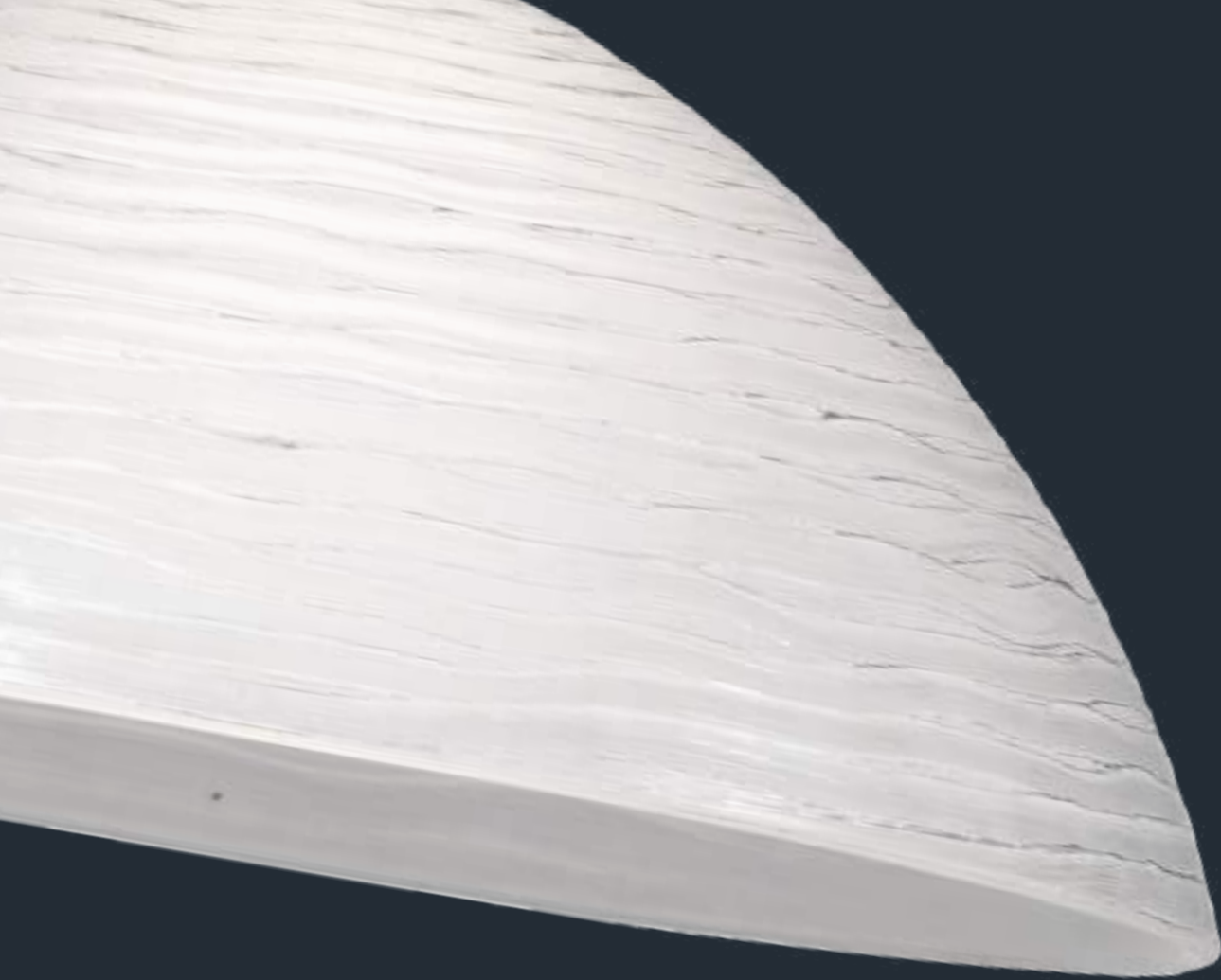

# SYRAH

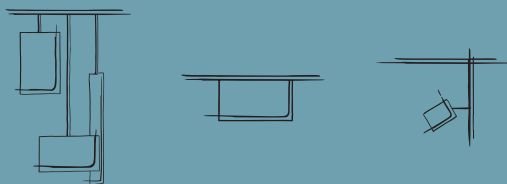

Lampada a sospensione, a soffitto e da parete in vetro cristallo con decorazioni incise in filo argento. Versione a soffitto disponibile in due misure. Struttura e particolari in metallo cromato, cavo della sospensione trasparente.

Pendant, ceiling and wall lamp in crystal glass with engraved decors in silver wire. Ceiling version available in two sizes. Structure and details in chrome metal, clear pendant cable.

MADE IN  
MILANO





Ø 400

220

**SYR002**

E27 1x75W max

cavo cable L.max 1200mm

rosone ceiling rose Ø100x60mm



⊕ ⊖ IP20 CE



Ø 300 / 400

80

**SYR006**

E27 1x75W max - Ø300 mm



**SYR005**

E27 2x75W max - Ø400 mm



⊕ ⊖ IP20 CE



250

250

∠120

**SYR007**

E27 1x75W max



⊕ ⊖ IP20 CE



# BALOS

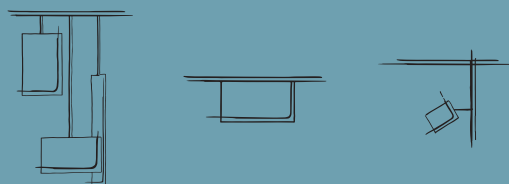

Lampada a sospensione, a soffitto e da parete in vetro curvato bianco satinato, con serigrafie che creano un gioco di trasparenze, facendo emergere una trama a cerchi concentrici. Particolari per la plafoniera e l'appliche in metallo cromato, cavo di sospensione e rosone bianchi. Versione a soffitto disponibile in due misure e relative potenze.

Pendant, ceiling and wall lamp in satin white bent glass, with decorations that create transparent effects, enhancing a pattern of concentric circles. Chrome metal details for the ceiling and wall versions, white suspension cable and ceiling rose. Ceiling version available in two sizes and related powers.

MADE IN  
MILANO



100

Ø 500

**BAL001**

E27 1x75W max  
cavo cable L.max 800mm  
rosone ceiling rose Ø70x50mm



□ ▽ IP20 CE



100

Ø 300 / 400

**BAL002**

E27 1x75W max - Ø 300 mm



**BAL003**

E27 2x75W max - Ø 400 mm



⊕ ▽ IP20 CE



150

300

↙80

**BAL005**

E27 1x75W max



□ ▽ IP20 CE



# MELVIN

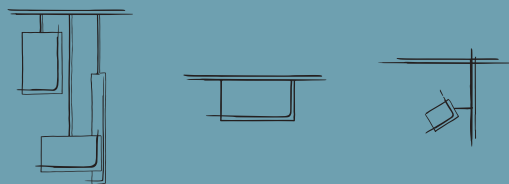

Lampada a sospensione, da parete e a soffitto in vetro satinato serigrafato. Struttura e particolari in metallo cromato.

Pendant, wall and ceiling lamp in decorated glass. Chrome metal structure and details.



525x400 / 645x500

80

**1073-40-B**

E27 1x75W max - L.525 mm



**1073-60-B**

E27 1x75W max - L.645 mm



cavo cable L.max 1000mm  
rosone ceiling rose Ø100x30mm

⊕ ⊖ IP20 CE



300 / 400 / 500

∟80

80



300 / 400

∟80

200

**1072-30-B**

E27 1x75W max - L.300 mm



**1072-40-B**

E27 2x75W max - L.400 mm



**1072-50-B**

E27 2x75W max - L.500 mm



⊕ ⊖ IP20 CE

**A.1072-30-B**

E27 1x75W max - L.300 mm



**A.1072-40-B**

E27 2x75W max - L.400 mm



⊕ ⊖ IP20 CE



# MELARA

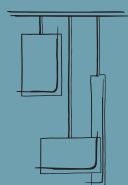

Lampada a sospensione con diffusore sottile in vetro cristallo extra chiaro, satinato centralmente. Proposta con con attacco E27 con lampadina a vista che consente all'utente di montare una lampadina a sua scelta, personalizzando ulteriormente il prodotto.

Pendant lamp with thin diffuser in extra-clear crystal glass, with satin finish at the centre. E27 lamp holder with visible lamp, that allows the user to mount a light bulb of his choice and further personalize the product.



690 x 390

100

**MEL001**

E27 2x75W max

cavo cable L.max 1000mm

rosone ceiling rose Ø120x60mm



⊕ ⊖ IP20 CE



Personalizzabile nella colorazione del vetro.  
Glass colours available upon request.



lampadina LED consigliata: L.283-6-OP-2K (pag. 729) recommended LED bulb: L.283-6-OP-2K (pag. 729)



# SODDY

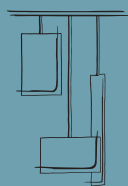

Lampada a sospensione con diffusore in vetro decorato a righe, struttura e rosone in metallo cromato. Disponibile in finitura cristallo trasparente e nera, cablata con attacco E27 che consente di montare lampadina LED.

Pendant lamp with glass diffuser with stripes decoration, structure and ceiling rose in chrome metal. Available in clear crystal and black finishes, E27 lamp holder that allows mounting LED lamp.





Ø 500

100

**1682**



E27 1x75W max

cavo cable L.max 1000mm

rosone ceiling rose Ø 120x30mm

⊕ ⚡ IP20 CE

CRI **N**



# PIAF

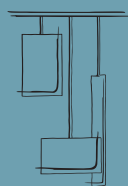

Lampada a sospensione in metacrilato colorato. Disponibile in tre finiture nelle versioni media e grande: bianco satinato, giallo e verde. Versione piccola (disponibile solo in bianco satinato) proposta anche in caduta multipla, con kit decentramento a tre elementi. Attacco E27 che consente di montare lampadina LED.

Pendant lamp in coloured methacrylate. Available in three finishes (satin white, yellow and green) for medium and large versions. Small version (available only in satin white finish) available also in multiple composition, with decentralization kit for three luminaires. E27 lamp holder that allows mounting LED lamp.



MADE IN  
MILANO



**PIA001**

E27 1x75W max  
cavo cable L.max 4000mm  
rosone ceiling rose Ø 120x28mm

☐ ▽ IP20 CE

SAT

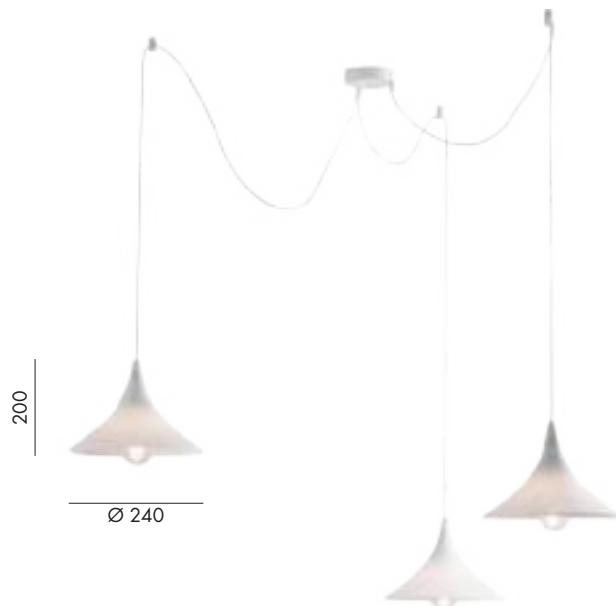

**PIA002**

E27 3x75W max  
cavo cable L.max 4000mm  
rosone ceiling rose Ø 120x28mm

☐ ▽ IP20 CE

SAT



**3485-40**

E27 1x75W max  
cavo cable L.max 800mm  
rosone ceiling rose Ø 120x80mm

☐ ▽ IP20 CE

SAT G V



**3485-55**

E27 1x75W max  
cavo cable L.max 800mm  
rosone ceiling rose Ø 120x80mm

☐ ▽ IP20 CE

SAT G V







DECORATIVO  
CLASSICO  
CLASSIC  
DECORATIVE



# LA SCALA



Lampada a sospensione e da parete in vetro di Murano soffiato a mano. Prodotto in stile classico ma con finiture colore moderne (rosa corallo e blu), proposto nella versione chandelier a cinque e otto bracci, da parete con due bracci, con attacco E14 che consente di montare lampadina a LED. Paralumi in tessuto shantung in finitura bianca, per un prodotto senza tempo.

Pendant and wall lamp in hand-blown Murano glass. Produced in classic style but with modern colour finishes (coral pink and blue), proposed with five or eight arms in the chandelier version, wall mounted with two arms. E14 lamp holder that allows mounting LED lamp. Lampshades in shantung fabric in white finish, for a timeless product.

**LAS001**

E14 5x40W max

cavo cable L.max 500mm

rosone ceiling rose Ø140x90mm

⊕ ⊖ IP20 CE

BLU RO



750

Ø 700

**LAS002**

E14 8x40W max

cavo cable L.max 500mm

rosone ceiling rose Ø140x90mm

⊕ ⊖ IP20 CE

BLU RO



850

Ø 1000





**LAS003**

E14 2x40W max



⊕ ⊖ IP20 CE

BLU RO



Personalizzabile nelle colorazioni del vetro soffiato e dei paralumi, nei dettagli proposti in finitura oro, nella composizione del prodotto con più o meno bracci e più o meno luci, su uno o più piani.

Available upon request: bespoke glass and lampshades colours, details available in gold finish, composition of the lamp with more or less arms and more or less lamp holders, arranged on one or more levels.









# MACBETH

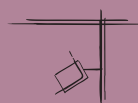
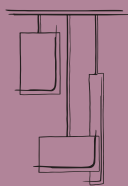

Lampada a sospensione e da parete in vetro di Murano soffiato a mano. Prodotto in stile classico rivisitato con linee moderne, proposto in due colori: bianco e fumè con particolari in cristallo e finiture metalliche cromate. Cablata con attacco E14 che consente di montare lampadina LED.

Pendant and wall lamp in hand-blown Murano glass. Classic luminaire reviewed with modern lines and available in two finishes: white and smoked grey with crystal details; chrome metal finishes. E14 lamp holder that allows mounting LED lamp.



600

Ø 800



280

530

∠ 220

**MAC001**

E14 5x40W max

cavo cable L.max 600mm

rosone ceiling rose Ø110x80mm



⊕ ⊖ IP20 CE



**MAC002**

E14 2x40W max

⊕ ⊖ IP20 CE



Personalizzabile nelle colorazioni del vetro soffiato, nei dettagli proposti in finitura oro, nella composizione del prodotto con più o meno bracci e più o meno luci, su uno o più piani.

Available upon request: bespoke glass colours, details available in gold finish, composition of the lamp with more or less arms and more or less lamp holders, arranged on one or more levels.





# CAROLINE

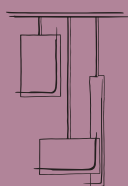

Lampada a sospensione e da parete in vetro di Murano soffiato a mano, proposto nelle finiture bianco latte, rosso e nero. Chandelier a sei bracci arricchito da pastorali e pendagli, decoro "rigadin". Struttura in metallo cromato. Attacco E14 con lampadina a vista che consente all'utente di montare una lampadina a sua scelta, personalizzando ulteriormente il prodotto.

Pendant and wall lamp in Murano artistic hand-blown glass available in pure white, red and black finish. Six-arm chandelier embellished with curled elements and pendants, "rigadin" décor. Chrome metal structure. E14 lamp holder with visible lamp, that allows the user to mount a light bulb of his choice and further personalize the product.



750

Ø 800

**1032**

E14 6x40W max

cavo cable L.max 500mm

rosone ceiling rose Ø90x60mm



⊕ ⊖ IP20 CE



470

320

∟280

**A.1032-1**

E14 1x40W max



⊕ ⊖ IP20 CE



**custom**  
made

Personalizzabile nelle colorazioni del vetro soffiato, nei dettagli proposti in finitura oro, nella composizione del prodotto con più o meno bracci e più o meno luci, su uno o più piani.

Available upon request: bespoke glass colours, details available in gold finish, composition of the lamp with more or less arms and more or less lamp holders, arranged on one or more levels.







# AMARAL



Lampada a sospensione e da parete in cristallo trasparente molato. Catena della sospensione e particolari in metallo cromato. Chandelier proposto a tre, cinque, otto bracci e per spazi importanti, a due piani (otto più quattro bracci). Proposto in versione semplice o con paralumi in cotone plissé bianco (da ordinare separatamente). Cablato con attacco E14 che consente di montare lampadina LED; nella versione senza paralumi l'apparecchio si può personalizzare ulteriormente con la scelta di lampadine a vista.

Pendant and wall lamp in bevelled clear crystal. Hanging chain and details in chrome metal. Chandelier available with three, five and eight arms, and eight plus four arms for bigger spaces. Available in simple version or with lampshades in white pleated cotton (to be ordered separately). E14 lamp holder that allows mounting LED lamp; the simple version can be further personalized by choosing visible lamps.



**AMA001**

E14 3x40W max  
cavo cable L.max 500mm  
rosone ceiling rose Ø90x60mm

⊕ ⊖ IP20 CE

**KITPAR003B**

KIT 3 paralumi  
3 lampshades kit



Ø 720

500

**AMA002**

E14 5x40W max  
cavo cable L.max 500mm  
rosone ceiling rose Ø90x60mm

⊕ ⊖ IP20 CE

**KITPAR005B**

KIT 5 paralumi  
5 lampshades kit



Ø 800

500

**AMA004**

E14 8x40W max

cavo cable L.max 500mm

rosone ceiling rose Ø90x60mm



⊕ ⊖ IP20 CE

**KITPAR008B**

KIT 8 paralumi

8 lampshades kit



550

Ø 900

**AMA008**

E14 8+4x40W max

cavo cable L.max 500mm

rosone ceiling rose Ø90x60mm



⊕ ⊖ IP20 CE

**KITPAR012B**

KIT 12 paralumi

12 lampshades kit



650

Ø 970

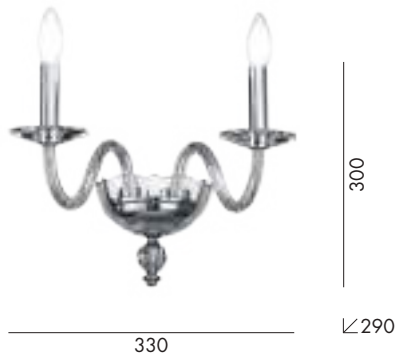

**AMA006**  
E14 2x40W max

⊕ ⊖ IP20 CE

**KITPAR002B**  
KIT 2 paralumi  
2 lampshades kit



**custom**  
made

Personalizzabile nelle colorazioni del vetro soffiato e dei paralumi in tessuto, nei dettagli proposti in finitura oro, nella composizione del prodotto con più o meno bracci e più o meno luci, su uno o più piani.

Available upon request: bespoke glass and lampshades colours, details available in gold finish, composition of the lamp with more or less arms and more or less lamp holders, arranged on one or more levels.





# JESSICA

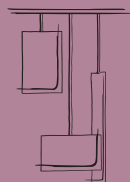

Lampada a sospensione e da parete in metallo cromato con paralumi in organza color avorio e pendagli in cristallo. Chandelier proposto con cinque o nove bracci; cablata con attacco E14 che consente di montare lampadina LED.

Pendant and wall lamp in chrome metal, with lampshades in ivory organza and crystal pendants. Chandelier available with five or nine arms; E14 lamp holder that allows mounting LED lamp.

MADE IN  
MILANO



550

Ø 650

**2074-5-AV**

E14 5x40W max  
cavo cable L.max 400mm  
rosone ceiling rose Ø90x60mm



⊕ ⊖ IP20 CE



650

Ø 780

**2074-6+3-AV**

E14 9x40W max  
cavo cable L.max 400mm  
rosone ceiling rose Ø90x60mm



⊕ ⊖ IP20 CE



340

340

∟280

**A.2074-1-AV**

E14 1x40W max



⊕ ⊖ IP20 CE





# ROYAL

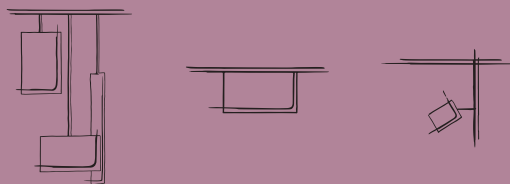

Lampadario in stile classico ma che ben si adatta anche a contesti moderni, dalle grandi dimensioni, con decorazioni sottili che ne esaltano la struttura importante pur nella sua leggerezza. Versione a sospensione, soffitto e da parete, realizzata in metallo laccato bianco con decori in filo di metallo curvato a forma di ricciolo. Attacco E14 con lampadina a vista che consente all'utente di montare una lampadina a sua scelta, personalizzando ulteriormente il prodotto.

Classic lamp of large sizes but with thin decors that exalt the imposing and at the same time light structure. It is suitable both for classic and modern locations. Available in the pendant, ceiling and wall versions; made in white lacquered metal round bar, decors in curled-shaped bent metal wire. E14 lamp holder with visible lamp, that allows the user to mount a light bulb of his choice and further personalize the product.



**ROY001**

E14 5x40W max

cavo cable L.max 600mm

rosone ceiling rose Ø 110x90mm

⊕ ⌵ IP20 CE



600

Ø 800



500

Ø 900



400

600

∠270

**ROY003**

E14 5x40W max

⊕ ⌵ IP20 CE



**ROY002**

E14 2x40W max

⊕ ⌵ IP20 CE





# BOLSHOI

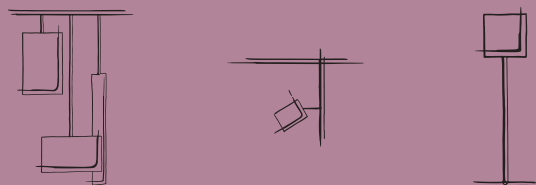

Lampada a sospensione, da parete e da terra in stile classico rivisitato con linee moderne. Struttura in metallo laccato bianco opaco. Chandelier proposto con sei o otto bracci, catena laccata bianca intrecciata al cavo elettrificato. La versione da terra presenta una struttura in metallo laccato bianco e un paralume in cotonette accoppiato PVC autoestinguente. Cablata con attacco E14 o E27 che consentono di montare lampadina LED.

Pendant, wall and floor lamp in reviewed classic style with modern lines. Structure in matt white lacquered metal. Chandelier available with six or eight arms, white lacquered chain interlaced to clear electrified cable. The floor version features a structure in white lacquered metal and a lampshade in cotonette matched to self-extinguishing PVC. E14 or E27 lamp holder that allows mounting LED lamp.

**BOL001**

E14 6x40W max

cavo cable L.max 600mm

rosone ceiling rose Ø110x90mm

⊕ ⚡ IP20 CE



520

Ø 670

**BOL002**

E14 8x40W max

cavo cable L.max 600mm

rosone ceiling rose Ø110x90mm

⊕ ⚡ IP20 CE



600

Ø 850



320

360

∠240

**BOL004**

E14 2x40W max

⊕ ⊖ IP20 CE



300

1730

Ø 450

**BOL005**

E27 1x75W max

⊕ ⊖ IP20 CE





# VIOLINA



Lampada a sospensione e da parete in cristallo trasparente "rigadin" ritorto con cristalli ottagonali e mandorle sfaccettate. Catena della sospensione, dettagli e rosone in metallo cromato. Attacco E14 che consente di montare lampadina LED.

Pendant and wall lamp in clear bent crystal, "rigadin" style, with octagonal crystals and faceted prisms. Hanging chain, details and ceiling rose in chrome metal. E14 lamp holder that allows mounting LED lamp.



600

Ø 520

**2021-5**

E14 5x40W max

cavo cable L.max 600mm

rosone ceiling rose Ø90x60mm



⊕ ⊖ IP20 CE



800

Ø 700

**2021-8**

E14 8x40W max

cavo cable L.max 600mm

rosone ceiling rose Ø90x60mm



⊕ ⊖ IP20 CE



190

330

∟280

**A.2021-2**

E14 2x40W max



⊕ ⊖ IP20 CE





Personalizzabile nelle applicazioni (versione da tavolo), nei dettagli proposti in finitura oro, nella composizione del prodotto con più o meno bracci e più o meno luci, su uno o più piani.

Available upon request: different applications (table version), details available in gold finish, composition of the lamp with more or less arms and more or less lamp holders, arranged on one or more levels.





# LYNETTE

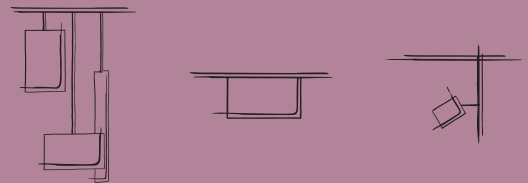

Lampada a sospensione, da soffitto e da parete, con struttura in metallo cromato e strass decorativi che creano giochi di luce sulla superficie su cui viene installata la lampada. Prodotto dalle dimensioni contenute ma altamente decorativo. Cablato con attacco E14 che consente di montare lampadina LED.

Pendant, ceiling and wall lamp with chrome metal structure and decorative rhinestones that create light effects on the surface on which the lamp is installed. Versatile product: though its small dimensions, it is highly decorative. E14 lamp holder that allows mounting LED lamp.



**3476**

E14 1x40W max

⊕ ⊖ IP20 CE



**3477-1**

E14 1x40W max

cavo cable L.max 800mm  
rosone ceiling rose Ø100x35mm

⊕ ⊖ IP20 CE



**A.3476**

E14 1x40W max

attacco a parete wall support Ø75x25mm

⊕ ⊖ IP20 CE



**A.2004-CR**

E14 1x40W max

⊕ ⊖ IP20 CE



**custom**  
made

Personalizzabile nei dettagli proposti in finitura oro, nella composizione del prodotto con più strass e con dimensioni maggiori.

Available upon request: details available in gold finish, composition of the lamp with more rhinestones and bigger dimensions.





 custom  
made

Swarovski

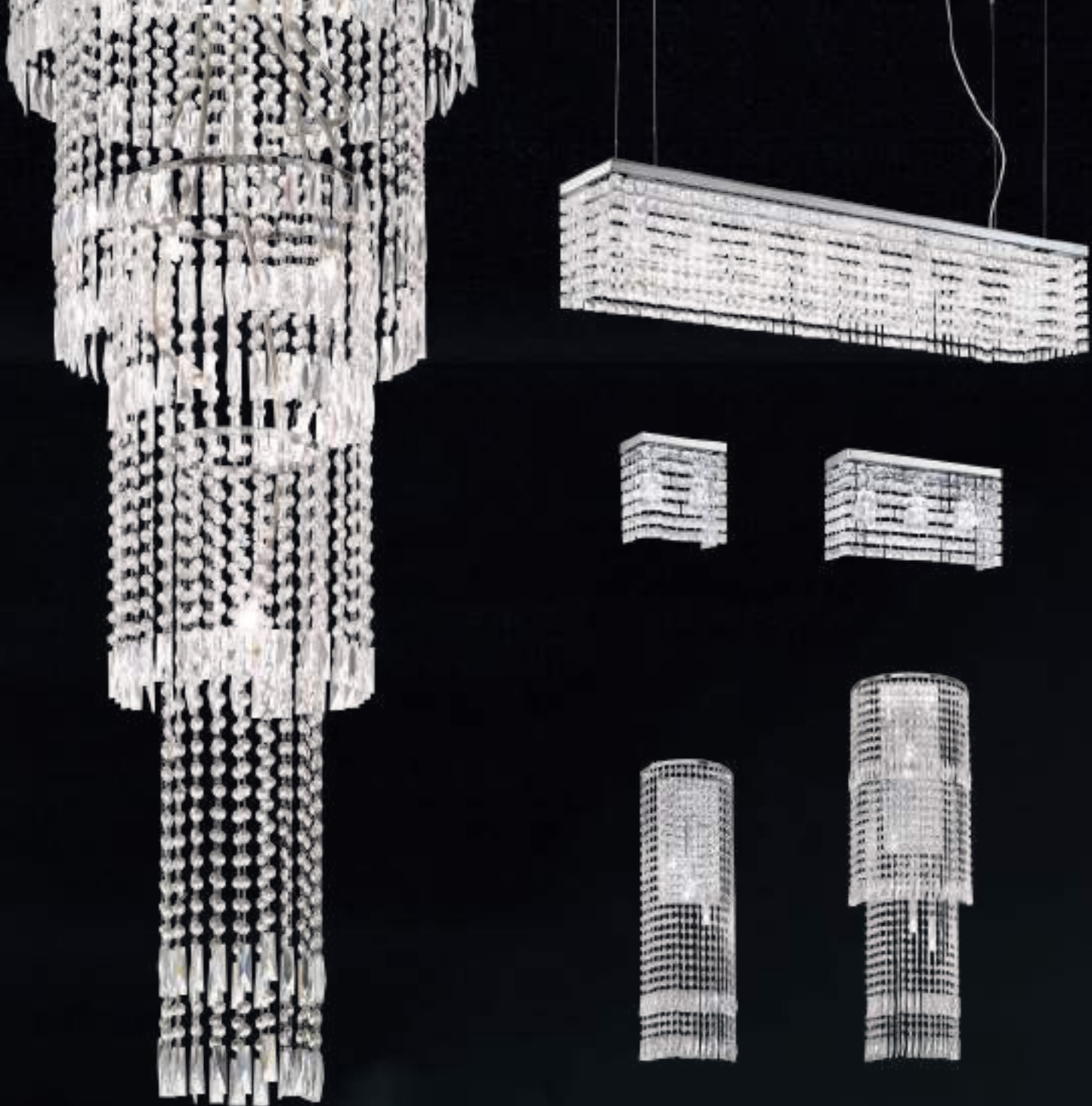

Possibilità di composizioni su misura e di grandi dimensioni, con struttura in finitura oro o cromo, in varie applicazioni (da soffitto, a sospensione, da parete, terra e tavolo). Contatta il nostro ufficio commerciale per quotazioni e tempistiche.

Available upon request: bespoke big composition, details and structure in gold or chrome finishes, different applications (wall, ceiling, pendant, table and floor versions). Please contact our sales office for quotations and delivery times.



# AMANDA

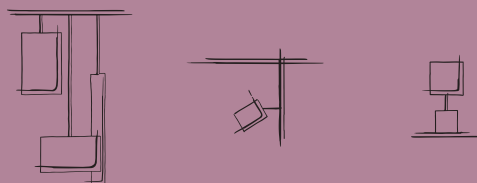

Lampada a sospensione, da parete e da tavolo in vetro di Murano soffiato a mano con decoro "baloton". Particolari in cristallo oro, tazza portalampada rivolta verso il basso con motivi lavorati a caldo. Chandelier proposto a cinque o sei bracci, prodotto cablato con attacco E14 che consente di montare lampadina LED.

Pendant, wall and table lamp in Murano glass, hand-blown with "baloton" décor; details in gold crystal, lamp holder cup facing downward with patterns realised at high temperatures. Chandelier available with five or six arms; E14 lamp holder that allows mounting LED lamp.



600

Ø 580

**2041-5**

E14 5x40W max

cavo cable L.max 500mm

rosone ceiling rose Ø 120x60mm

⊕ ⊖ IP20 CE



800

Ø 870

**2041-6**

E14 6x40W max

cavo cable L.max 500mm

rosone ceiling rose Ø 120x60mm

⊕ ⊖ IP20 CE



420

500

**A.2041-2**

E14 2x40W max

⊕ ⊖ IP20 CE



350

Ø 190

**P.2041**

E14 1x40W max

⊕ ⊖ IP20 CE







Personalizzabile nei dettagli proposti in finitura cromo, nella composizione del prodotto con più o meno bracci e più o meno luci, su uno o più piani.

Available upon request: details available in chrome finish, composition of the lamp with more or less arms and more or less lamp holders, arranged on one or more levels.





# FLORAL

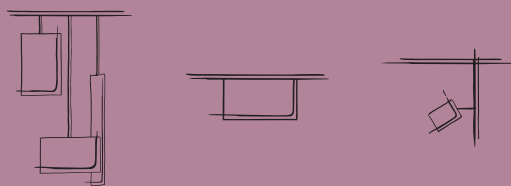

Lampada a sospensione, da soffitto e da parete in vetro di Murano soffiato a mano, lavorato "rigadin" con decori oro. Tazza portalampada rivolta verso il basso, struttura in ottone oro lucido. Cablata con attacco E14 che consente di montare lampadina LED.

Pendant, ceiling and wall lamp in hand-blown Murano glass in "rigadin" style, with gold decors. Lamp holder cup facing downward, structure in polished gold brass. E14 lamp holder that allows mounting LED lamp.



**1036-70**  
E14 6x40W max

⊕ ⊖ IP20 CE

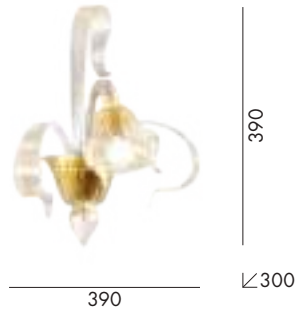

**A.1036-1**  
E14 1x40W max

⊕ ⊖ IP20 CE



**1036**  
E14 6x40W max  
cavo cable L.max 400mm  
rosone ceiling rose Ø120x60mm

⊕ ⊖ IP20 CE



Personalizzabile nelle applicazioni (versione da tavolo), nei dettagli proposti in finitura cromo, nella composizione del prodotto con più o meno bracci e più o meno luci, su uno o più piani.

Available upon request: different applications (table version), details available in chrome finish, composition of the lamp with more or less arms and more or less lamp holders, arranged on one or more levels.





# METROPOLITAN

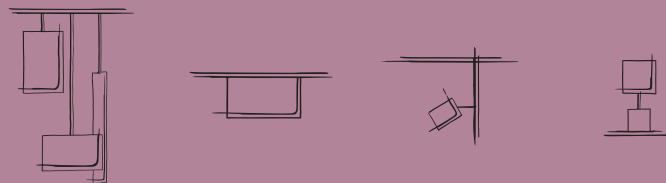

Lampada a sospensione, da soffitto, da parete e da tavolo in vetro di Murano soffiato a mano. Decoro foglie e fiori in vetro bianco latte lavorato "rigadin" con particolari in cristallo trasparente. Cablata con attacco E14 che consente di montare lampadina LED.

Pendant, ceiling, wall and table lamp in hand-blown Murano glass. Leaves and flowers décor in pure white worked in "rigadin" style with clear crystal details. E14 lamp holder that allows mounting LED lamp.



Ø 650

700

**2064-3**

E14 3x40W max

cavo cable L.max 600mm

rosone ceiling rose Ø 120x70mm



⊕ ⊖ IP20 CE



Ø 1000

850

**2064-8**

E14 8x40W max

cavo cable L.max 600mm

rosone ceiling rose Ø 120x70mm



⊕ ⊖ IP20 CE



Ø 800

650

**2064**

E14 5x40W max

⊕ ⊖ IP20 CE



450

450

↙ 300

**A.2064-2**

E14 2x40W max

⊕ ⊖ IP20 CE





Ø 160

300

**P.2064**

E14 1x40W max



□ ▽ IP20 CE



**custom**  
made

Personalizzabile nelle colorazioni del vetro soffiato, nei dettagli proposti in finitura oro, nella composizione del prodotto con più o meno bracci e più o meno luci, su uno o più piani.

Available upon request: bespoke glass colours, details available in gold finish, composition of the lamp with more or less arms and more or less lamp holders, arranged on one or more levels.





# MEREDITH

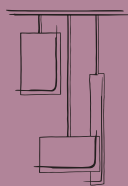

Lampada a sospensione e da parete in vetro di Murano soffiato a mano realizzata a mano con decoro "baloton". Chandelier proposto a cinque o sei bracci. Particolari in cristallo oro, tazza portalampada rivolta verso l'alto con motivi lavorati a caldo. Attacco E14 con lampadina a vista che consente all'utente di montare una lampadina a sua scelta, personalizzando ulteriormente il prodotto.

Pendant and wall lamp in Murano glass, hand-blown with "baloton" décor. Chandelier with five or six arms. Details in gold crystal, lamp holder cup facing upward with patterns realised at high temperatures. E14 lamp holder with visible lamp, that allows the user to mount a light bulb of his choice and further personalize the product.



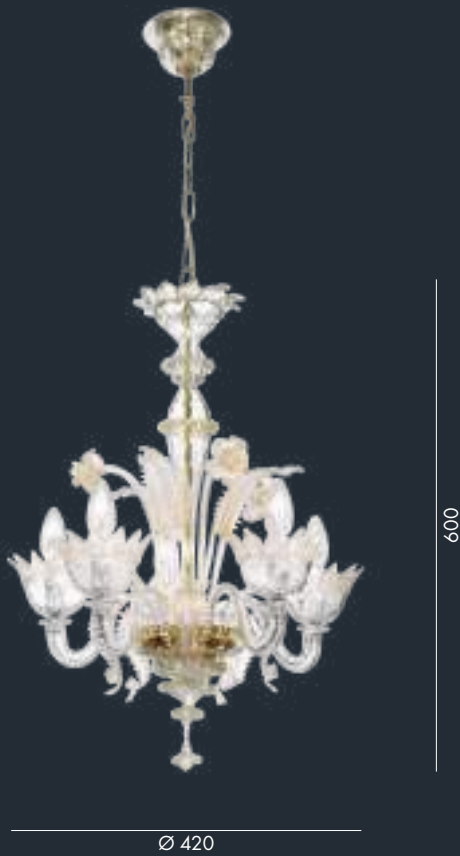

Ø 420

600

**2040-5**

E14 5x40W max

cavo cable L.max 400mm

rosone ceiling rose Ø 120x60mm



⊕ ⊖ IP20 CE



Ø 700

750

**2040-6**

E14 6x40W max

cavo cable L.max 400mm

rosone ceiling rose Ø 120x60mm



⊕ ⊖ IP20 CE



400

400

∟ 250

**A.2040-2**

E14 2x40W max



⊕ ⊖ IP20 CE

custom  
made



Personalizzabile nei dettagli proposti in finitura cromo, nella composizione del prodotto con più o meno bracci e più o meno luci, su uno o più piani.

Available upon request: details available in chrome finish, composition of the lamp with more or less arms and more or less lamp holders, arranged on one or more levels.



# REGIO

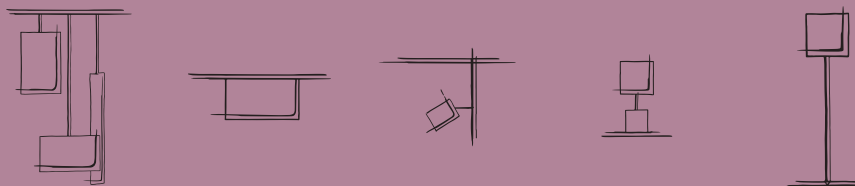

Lampada a sospensione, a soffitto, da parete, tavolo e terra con struttura con bracci e foglie realizzate in lamina di metallo curvato; metallo laccato avorio con spennellature oro eseguite a mano. Tazza portalam-pada a forma di fiore in vetro cristallo colore ambra, realizzato con la tecnica del vetro colato a caldo, profili pinzati a mano. Cablata con attacco E14 che consente di montare lampadina LED.

Pendant, ceiling, wall, table and floor lamp with structure featuring arms and leaves made in bent metal sheet; ivory lacquered metal with handmade gold strokes. Flower-shaped lamp holder cup in amber colour crystal glass, made with cast glass technique at high temperature, handmade. E14 lamp holder that allows mounting LED lamp.



450

Ø 600

**REG001**

E14 3x40W max  
cavo cable L.max 600mm  
rosone ceiling rose Ø110x90mm



⊕ ⊖ IP20 CE



450

Ø 620

**REG002**

E14 5x40W max  
cavo cable L.max 600mm  
rosone ceiling rose Ø110x90mm



⊕ ⊖ IP20 CE



180

Ø 700

**REG003**

E14 5x40W max



⊕ ⊖ IP20 CE



180

1220 x 900

**REG004**

E14 8x40W max



⊕ ⊖ IP20 CE



420

370

∟ 200

**REG005**

E14 2x40W max

⊕ ⊖ IP20 CE



300

∅ 200

**REG007**

E14 1x40W max

⊕ ⊖ IP20 CE



1850

∅ 330

**REG006**

E14 3x40W max

⊕ ⊖ IP20 CE





# SALOMÈ

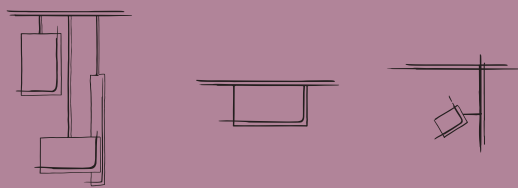

Lampada a sospensione, da soffitto e da parete in metallo verniciato oro spazzolato, decori a foglia con elementi in cristallo e tazze portalampada in vetro ambra rivolte verso il basso. Cablata con attacco E14 che consente di montare lampadina LED.

Pendant, ceiling and wall lamp in brushed gold painted metal, leaves décor with crystal elements and lamp holder cups facing downward in amber glass. E14 lamp holder that allows mounting LED lamp.



480

Ø 800

**10322-5**

E14 5x40W max

cavo cable L.max 400mm

rosone ceiling rose Ø110x90mm



⊕ ⊖ IP20 CE



250

Ø 700

**10323-3**

E14 3x40W max

⊕ ⊖ IP20 CE



280

Ø 800

**10323-5**

E14 5x40W max

⊕ ⊖ IP20 CE



440

390

∠210

**A.10322-2**

E14 2x40W max

⊕ ⊖ IP20 CE





# FELICE

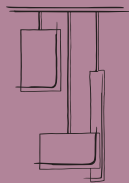

Lampadario classico in stile rustico, proposto nella versione a sospensione da tre, cinque o otto bracci e nella versione da parete. Montatura in metallo decorato con spennellature oro realizzate a mano. Proposto nella versione avorio e nero anticato. Attacco E14 con lampadina a vista che consente all'utente di montare una lampadina a sua scelta, personalizzando ulteriormente il prodotto.

Classic chandelier in rustic style, available in the pendant version with three, five or eight arms and in the wall version. Lamp featuring metal arms decorated with handmade gold strokes. Available in the ivory and antiqued black versions. E14 lamp holder with visible lamp, that allows the user to mount a light bulb of his choice and further personalize the product.





**FEL001**

E14 3x40W max  
 cavo cable L.max 600mm  
 rosone ceiling rose Ø110x70mm

⊕ ⊖ IP20 CE



**FEL002**

E14 5x40W max  
 cavo cable L.max 600mm  
 rosone ceiling rose Ø110x70mm

⊕ ⊖ IP20 CE



**FEL003**

E14 8x40W max  
 cavo cable L.max 600mm  
 rosone ceiling rose Ø110x70mm

⊕ ⊖ IP20 CE

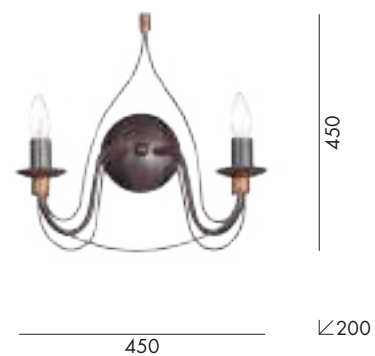

**FEL004**

E14 2x40W max

⊕ ⊖ IP20 CE





# LUKE

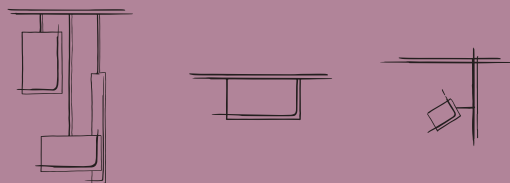

Lampada a sospensione, da soffitto e da parete in ceramica. Finitura bianca o con decorazioni blu o marroni realizzate a mano. Sbraccio dell'appliche in ferro battuto. L'articolo va ordinato componendo la struttura e il diffusore (nella versione sospesa diffusore Ø200 e 400mm nella versione parete/plafone diffusore Ø200mm). Prodotto da personalizzare e implementare con accessori quali cavo a treccia, scatola di derivazione, interruttore/deviatore e isolatore in ceramica per creare un impianto elettrico completo o deviare il punto luce. Attacco E27 con lampadina a vista che consente all'utente di montare una lampadina a sua scelta, personalizzando ulteriormente il prodotto.

Pendant, ceiling and wall lamp in ceramic. Available in white finish or with blue or brown handmade decors. Applique structure in wrought iron. The luminaire has to be composed of structure and diffuser (Ø200 or 400mm for the suspended version, Ø200mm for the ceiling/wall version). It can be customised with accessories like braided cable, junction box, switch and insulator in ceramic to create a complete electric system or to deviate the light source. E27 lamp holder with visible lamp, that allows the user to mount a light bulb of his choice and further personalize the product.



MADE IN  
MILANO



**9530-B**

E27 1x75W max  
 cavo cable L.max 800mm  
 rosone ceiling rose Ø100x60mm



⊕ ⊖ IP20 CE

completare con diffusore Ø 200 o 400 mm  
 complete with diffuser Ø 200 or 400 mm



**9531-B**

E27 1x75W max  
 cavo cable L.max 800mm  
 rosone ceiling rose Ø140x80mm



⊕ ⊖ IP20 CE

completare con diffusore Ø 200 o 400 mm  
 complete with diffuser Ø 200 or 400 mm



**A.9522**

E27 1x75W max



⊕ ⊖ IP20 CE



completare con diffusore Ø 200 mm  
 to complete with diffuser Ø 200 mm



**A.9521**

E27 1x75W max



⊕ ⊖ IP20 CE



completare con diffusore Ø 200 mm  
 to complete with diffuser Ø 200 mm

**ACCESSORI - DIFFUSORI / ACCESSORIES - DIFFUSERS**



**D.9550-20-B**

Ø 200 mm



**D.9550-20-BLU**

Ø 200 mm



**D.9550-20-MA**

Ø 200 mm

**D.9550-40-B**

Ø 400 mm

**D.9550-40-BLU**

Ø 400 mm

**D.9550-40-MA**

Ø 400 mm

**ACCESSORI - SISTEMA / ACCESSORIES - SYSTEM**



**5001**

Interruttore/Deviatore  
Switch/Diverter



**C.5-375-10-B**

10 mt cavo treccia/braided cable



**5003**

Scatola di derivazione  
Junction box



**5004**

Rosone in ceramica  
Ceramic ceiling/wall rose



**5002**

Isolatore in ceramica  
Ceramic insulator



**MT.5001**

Presca elettrica  
Socket

**ESEMPIO DI COMPOSIZIONE / COMPOSITION EXAMPLE**





9530-B  
+  
D.9550-40-BLU

MT.5001





# KAREN

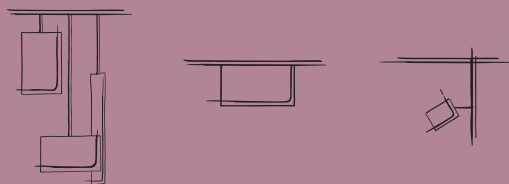

Lampada a sospensione, da soffitto e da parete con struttura in ottone anticato. Da completare con i diffusori, disponibili in tre diametri nelle varianti in vetro bianco lucido, in ceramica decorata o in ottone. Sospensione disponibile con tige rigida, con contrappeso o con cavo in cotone a treccia; plafoniera proposta in versione singola o doppia. Cablata con attacco E27 che consente di montare lampadina LED.

Pendant, ceiling and wall lamp with structure in antique brass. To be completed with diffusers, available in three sizes and in different materials: polished white glass, decorated ceramic or brass. Suspension available with stem, with counterweight or with braided cotton cable; ceiling version available single or double. E27 lamp holder that allows mounting LED lamp.



MADE IN  
MILANO



**9401**

E27 2x75W max

rosone ceiling rose Ø 130x50mm

⊕ ⊖ IP20 CE

completare con diffusore max Ø 320mm pag. 652

complete with diffuser max Ø 320mm pag. 652



**9402**

E27 1x75W max

cavo cable L.max 1850mm

rosone ceiling rose Ø 180x50mm

⊕ ⊖ IP20 CE

completare con diffusore pag. 652

complete with diffuser pag. 652



**9403**

E27 1x75W max

cavo cable L.max 1200mm

rosone ceiling rose Ø 100x70mm

⊕ ⊖ IP20 CE

completare con diffusore pag. 652

complete with diffuser pag. 652



**9404**

E27 2x75W max

cavo cable L.max 1200mm

rosone ceiling rose Ø 180x50mm

⊕ ⊖ IP20 CE

completare con diffusore pag. 652

complete with diffuser pag. 652





**9405**

E27 1x75W max  
rosone ceiling rose Ø110x40mm

⊕ ▽ IP20 CE

completare con diffusore pag. 652  
complete with diffuser pag. 652



**9406**

E27 2x75W max  
rosone ceiling rose Ø180x50mm

⊕ ▽ IP20 CE

completare con diffusore max Ø 320mm pag. 652  
complete with diffuser max Ø 320mm pag. 652



**A.9407**

E27 1x75W max  
attacco a parete wall support Ø110x40mm

⊕ ▽ IP20 CE

completare con diffusore pag. 652  
complete with diffuser pag. 652



**A.9408**

E27 1x75W max  
attacco a parete wall support Ø110x40mm

⊕ ▽ IP20 CE

completare con diffusore pag. 652  
complete with diffuser pag. 652



**A.9409**

E27 1x75W max  
attacco a parete wall support Ø110x40mm

⊕ ▽ IP20 CE

completare con diffusore pag. 652  
complete with diffuser pag. 652

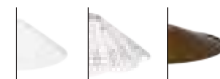

**DIFFUSORI / DIFFUSER**



Ø 200

**V.9501-20**

diffusore in vetro / glass diffuser



Ø 250

**V.9501-25**

diffusore in vetro / glass diffuser



Ø 300

**V.9501-30**

diffusore in vetro / glass diffuser



Ø 220

**D.9504-18**

diffusore in ceramica bianca /  
white ceramic diffuser



Ø 320

**D.9504-32**

diffusore in ceramica bianca /  
white ceramic diffuser



Ø 400

**D.9504-40**

diffusore in ceramica bianca /  
white ceramic diffuser



Ø 200

**D.9503-20**

diffusore in ottone / brass diffuser



Ø 290

**D.9503-29**

diffusore in ottone / brass diffuser



Ø 350

**D.9503-35**

diffusore in ottone / brass diffuser





# CILEA

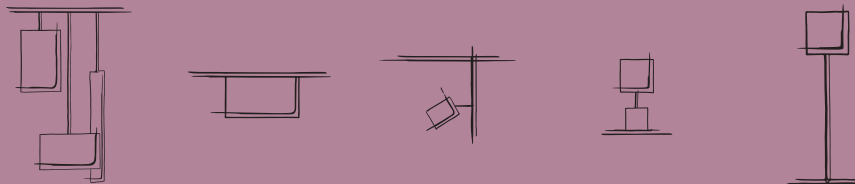

Lampada a sospensione, da soffitto, da parete, da tavolo e da terra con bracci realizzati in metallo curvato a mano. Il metallo è laccato marrone con spennellature artigianali in oro eseguite a mano. Decorì in metallo con motivi di foglie e fiori. Portalampada a forma di fiore realizzato con la tecnica del vetro colato, vetro bianco sfumato cristallo verso il bordo, con attacco E14 per alloggiare lampadina LED.

Pendant, ceiling, wall, table and floor lamp with handmade bent metal arms. The metal is lacquered brown, with handmade strokes in gold. Metal decors with leaf and flower patterns. Flower-shaped lamp holder cup made with cast glass technique; white glass with crystal edges, with E14 lamp holder for LED lamps.



460

Ø 650

**CIL002**

E14 5x40W max

cavo cable L.max 600mm

rosone ceiling rose Ø 110x90mm

⊕ ⊖ IP20 CE



480

Ø 800

**CIL003**

E14 8x40W max

cavo cable L.max 600mm

rosone ceiling rose Ø 110x90mm

⊕ ⊖ IP20 CE



170

700 x 400

**CIL005**

E14 4x40W max

⊕ ⊖ IP20 CE



170

Ø 740

**CIL006**

E14 6x40W max

⊕ ⊖ IP20 CE







450

Ø 400

∟ 170

**CIL007**

E14 2x40W max



⊕ ⊖ IP20 CE



300

Ø 180

**CIL008**

E14 1x40W max



⊕ ⊖ IP20 CE



1800

Ø 350

**CIL009**

E14 3x40W max



⊕ ⊖ IP20 CE



# FENICE

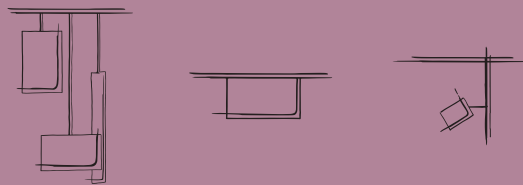

Lampada a sospensione, da soffitto e da parete realizzata in vetro cristallo satinato centrifugato; decori con motivo floreale marrone e oro eseguiti a mano. Parti metalliche e catena per la sospensione in metallo brunito. Cablata con attacco E27 che consente di montare lampadina LED.

Pendant, ceiling and wall lamp made in spun satin crystal glass; handmade decors with brown and gold floral patterns. Metal parts and hanging chain in burnished metal. E27 lamp holder that allows mounting LED lamp.



**FEN002**

E27 1x75W max  
cavo cable L.max 400 mm  
rosone ceiling rose Ø 110x70mm



☐ ▽ IP20 CE



**FEN004**

E27 1x75W max - Ø 300 mm



**FEN005**

E27 2x75W max - Ø 400 mm



☐ ▽ IP20 CE



**FEN007**

E27 1x75W max



☐ ▽ IP20 CE



# GIGLIO

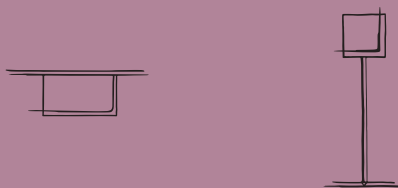

Lampadario classico a soffitto e da terra composto da bracci realizzati in metallo curvato laccato bianco. Tazza portalampada a forma di calla realizzata a mano, con la tecnica del vetro colato; vetro bianco sfumato cristallo verso il bordo, con attacco E14 per alloggiare lampadina LED.

Classic ceiling and floor lamp with white bent lacquered metal. Flower-shaped lamp holder cup, handmade with cast glass technique; white glass with crystal edge, with E14 lamp holder for LED lamps.

MADE IN  
MILANO



**GIG001**  
E14 6x40W max - Ø 600 mm

**GIG002**  
E14 8x40W max - Ø 700 mm

⊕ ⊖ IP20 CE



**GIG005**  
E14 3x40W max

⊕ ⊖ IP20 CE



# FRANCIS



Lampada a sospensione e da parete con struttura in metallo ottonato (oro lucido). Tazze portalampada rivolte verso il basso in vetro satinato. Applique con accensione tramite corda tiretto. Cablata con attacco E14 che consente di montare lampadina LED.

Pendant ad wall lamp with structure in brass metal (polished gold). Lamp holder cups facing downward in satin glass. Applique switched on with pull-cord. E14 lamp holder that allows mounting LED lamp.

MADE IN  
MILANO



Ø 540

320

**3788-5-OL**

E14 5x40W max

cavo cable L.max 400mm

rosone ceiling rose Ø90x60mm



⊕ ⊖ IP20 CE



Ø 150

350

∠260

**A.3788-OL**

E14 1x40W max



⊕ ⊖ IP20 CE



# LIBBY

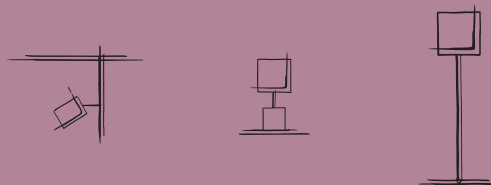

Lampada da parete, da tavolo e da terra con struttura in ottone lucido rigato e diffusore in cotonette accoppiato PVC autoestinguente. Applique proposta nella versione con uno o due portalamпада; prodotto cablato con attacco E27 che consente di montare lampadina LED. Apparecchio adatto in contesto residenziale o hospitality.

Wall, table and floor lamp with grained polished brass and cotonette diffuser coupled to self-extinguishing PVC. Applique available in the version with one or two lamp holders; E27 lamp holder that allows mounting LED lamp. Luminaire suitable for residential or hospitality areas.



**A.3061-1**

E27 1x75W max

⊕ ▽ IP20 CE



**A.3061-2**

E27 2x75W max

⊕ ▽ IP20 CE



**P.3061-35**

E27 1x75W max

⊕ ▽ IP20 CE

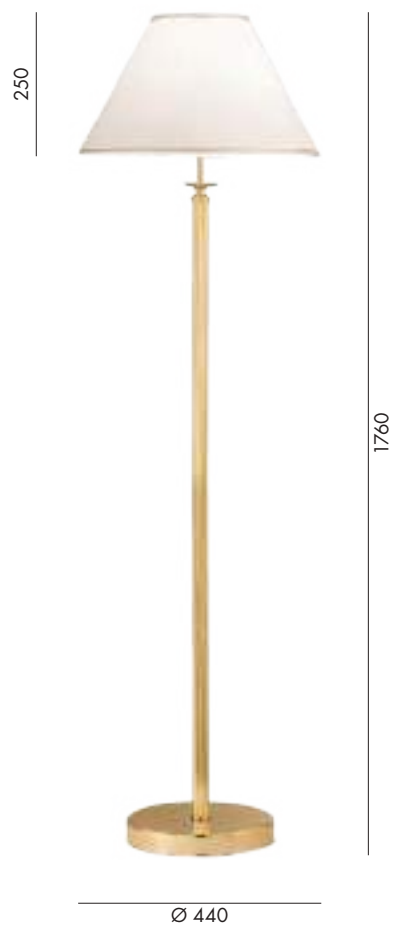

**T.3061**

E27 1x75W max

⊕ ▽ IP20 CE





# ANNETTE



Lampada da tavolo con struttura in ceramica lavorata a mano in finitura grigia e paralume in cotone accoppiato PVC autoestinguente. Cablata con attacco E27 che consente di montare lampadina LED.

Table lamp with hand-decorated ceramic structure and cotton lampshade matched to self-extinguishing PVC. E27 lamp holder that allows mounting LED lamp.

MADE IN  
MILANO



**ANN001**

E27 1x75W max



□ ▽ IP20 CE



restyle



450

Ø 250

P.1962-25

E14 1x40W max



⊕ ⊖ IP20 CE



# WENDY



Lampada da tavolo con struttura in vetro di Murano cristallo "rigadin" con inserti cristallo oro (versione ambra e bianca) o cristallo trasparente (versione rossa e nera). Paralume in tessuto raso, plissettato, proposto nei colori bianco, rosso, nero e ambra. Disponibile in due misure, con attacco E14 e E27 che consentono di montare lampadine LED.

Table lamp with structure in Murano crystal glass, "rigadin style" with gold crystal elements (amber or white version) or clear crystal (red and black version). Lampshade in satin, pleated fabric, available in white, red, black and amber finish. Available in two sizes, with E14 or E27 lamp holders that allow mounting LED lamp.



700

Ø 400

P.1962-40

E27 1x75W max



⊕ ⊖ IP20 CE



MADE IN MURANO



# ALICE



Lampada da tavolo in due dimensioni con struttura in cristallo al piombo trasparente, in finitura cromo. Paralume in cotonette accoppiato PVC autoestinguente bianco. Cablata con attacco E27 che consente di montare lampadina LED.

Table lamp with structure in clear crystal with chrome galvanic finishes. Lampshade in white cottonette matched to self-extinguishing PVC. Available in two sizes, with E27 lamp holder that allows mounting LED lamp.

530 / 630



Ø 300 / 400

**P.9785-30-CR**

E27 1x75W max - Ø 300 mm



**P.9785-40-CR**

E27 1x75W max - Ø 400 mm



⊕ ⊖ IP20 CE

MADE IN  
MURANO



# JARVIS



Lampada da soffitto e da parete in vetro lavorato graniglia trasparente, con struttura in metallo ottonato. Disponibile in quattro misure e relative potenze. Cablata con attacco E14 e E27 che consentono di montare lampadina LED.

Ceiling and wall lamp in glass worked with clear grit, with structure in brass metal. Available in four different sizes and related powers. E14 and E27 lamp holders that allow mounting LED lamp.

MADE IN  
MURANO



130 / 130 / 140 / 160

Ø 320 / 380 / 490 / 580

**2037-30**   
E14 2x40W max - Ø 320 mm

**2037-40**   
E27 3x42W max - Ø 380 mm

**2037-50**   
E27 5x42W max - Ø 490 mm

**2037-60**   
E27 6x42W max - Ø 580 mm

  IP20 CE



# SERENA



Lampada da soffitto e da parete in vetro graniglia trasparente con decorazione "fracco". Pendaglio in cristallo trasparente e particolari in metallo dorato. Plafoniera disponibile in diversi diametri e relative potenze. Cablata con attacco E27 che consente di montare lampadina LED.

Ceiling and wall lamp in clear grit glass with "fracco" décor. Pendant in clear crystal and details in gold metal. Ceiling version available in different sizes and related powers. E27 lamp holder that allows mounting LED lamp.

**10520-30**

E27 2x75W max - Ø 300 mm



**10520-40**

E27 2x75W max - Ø 400 mm



**10520-50**

E27 3x75W max - Ø 500 mm



⊕ ▽ IP20 CE



**A.10520**

E27 1x75W max



⊕ ▽ IP20 CE





# NICKY

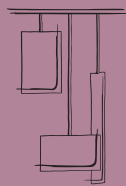

Lampada a sospensione saliscendi con montatura in metallo laccato bianco e diffusore in vetro decorato satinato o colorato. Cablata con attacco E27 che consente di montare lampadina LED.

Pendant lamp with latch mechanism with structure in white lacquered metal and satin decorated glass diffuser. Available in white or coloured version. E27 lamp holder that allows mounting LED lamp.



**3448**

E27 1x75W max

cavo cable L.max 800 mm

rosone ceiling rose Ø90x120mm

⊕ ⊖ IP20 CE



**3445**

E27 1x75W max

cavo cable L.max 800 mm

rosone ceiling rose Ø90x120mm

⊕ ⊖ IP20 CE





# CANDICE



Lampada a soffitto con struttura in metallo verniciato finitura ruggine, diffusore in vetro con greca decorata a mano. Proposta in tre misure e relative potenze, cablata con attacco E27 che consente di montare lampadina LED.

Ceiling lamp with structure in painted metal rust finish, glass diffuser with hand-decorated relief pattern. Available in three sizes and related powers; E27 lamp holder that allows mounting LED lamp.

MADE IN  
MILANO

Ø 300



∟ 110

**931-30**

E27 2x75W max



⊕ ∇ IP20 CE

Ø 400



∟ 125

**931-40**

E27 2x75W max



⊕ ∇ IP20 CE

Ø 500



∟ 145

**931-50**

E27 3x75W max



⊕ ∇ IP20 CE





# FELIX

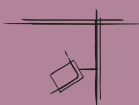

Lampada da parete e a soffitto; struttura in metallo laccato e diffusore in vetro bianco opaco. Decoro a scavo disponibile in due varianti di colore bianco e marrone. Cablata con attacco E27 che consente di montare lampadina LED.

Wall and ceiling lamp; lacquered metal structure and satin glass diffuser. Hollow décor available in two colours: white and brown. E27 lamp holder that allows mounting LED lamp.

MADE IN MILANO

Ø 300



∠80

**3909-30**  
E27 1x75W max



⊕ ⊖ IP20 CE



Ø 400



∠110

**3909-40**  
E27 2x75W max



⊕ ⊖ IP20 CE



300

160



∠80

**A.3909**  
E27 1x75W max



⊕ ⊖ IP20 CE







LAMPAD  
DA ESTERNO  
OUTDOOR



# PIC-NIC



Lampada da tavolo a LED (2700K), portatile e ricaricabile, ideale per illuminare terrazze e giardini, ma perché no, anche per rallegrare il tuo picnic al parco. Una lampada senza fili, che ti segue ovunque tu voglia andare. Struttura in pressofusione di alluminio verniciato con pretrattamento per uso da esterno (grado di protezione IP54). Accensione con interruttore touch e ricarica tramite USB, durata della batteria 9 ore. Disponibile in tre varianti di colore (bianco, antracite e corten) e in due altezze. Possibilità di sospensione tramite corda in finitura ecrù (5 mt) da ordinare come accessorio.

LED table lamp (2700K), portable and rechargeable, perfect for terraces and gardens and why not for cheer up your picnic at the park. The wireless lamp following you wherever you go. Die-cast aluminium body with pretreatment finishing for outdoor (protection grade IP54). Touch switch, charges through a USB cable, battery life 9 hours. Available in three finishes (white, anthracite, corten) and two heights. Available suspension rope in ecru finishing (5 mt) to be ordered as accessory.



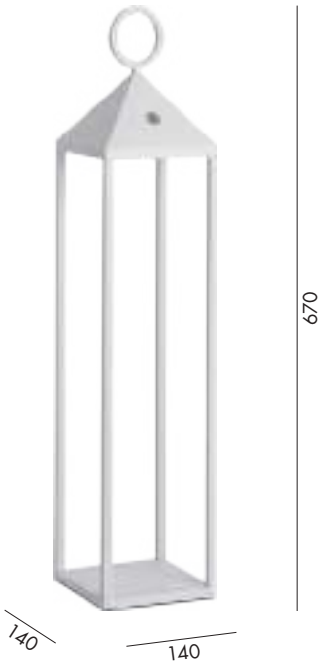

**PIN002**

LED 2,2W  
2700K 200 lm  
durata life 9 H  
ricarica recharge 5-7 H



**PIN001**

LED 2,2W  
2700K 200 lm  
durata life 9 H  
ricarica recharge 5-7 H



**PIN010**

corda per sospensione 5mt  
suspension rope 5 mt.



caricatore USB multiplo a 8 porte cod. MT.8USB (pag. 745) 8-port multiple multiple USB charger cod. MT.8USB (pag. 745)





# SIESTA



Lampada da tavolo a LED (2700K), portatile e ricaricabile. Ideale per ambienti outdoor, si presta ottimamente anche per utilizzo in interno. Grazie all'emissione di luce confortevole e modulabile, è perfetta per il tavolo da pranzo o l'angolo conversazione, in ambiente domestico ma anche nel mondo della ristorazione. Struttura in pressofusione di alluminio verniciato a polvere con pretrattamento per uso da esterno (grado di protezione IP54), cover led in policarbonato e guarnizione in gomma siliconica. Accensione con interruttore touch dimmer e ricarica tramite USB, durata della batteria 9 ore. Disponibile in quattro varianti di colore: bianca, nera, blu e corten.

LED table lamp (2700K), portable and rechargeable, ideal for outdoor but also for indoor applications. Thanks to its comfortable and variable lighting emission, it is perfect for the dining tables or your conversation places, in domestic but also in catering locations. Body in powder coated die-cast aluminium with pretreatment finishing for outdoor places (protection grade IP54). Led cover in polycarbonate and silicon rubber gasket. Touch switch, charges through a USB cable, battery life 9 hours. Available in four finishes: white, black, blue and corten.



**SIE001**

LED 2,2W

2700K 200 lm

durata life 9 H

ricarica recharge 5-7 H









caricatore USB multiplo a 8 porte cod. MT.8USB (pag. 745) 8-port multiple multiple USB charger cod. MT.8USB (pag. 745)

DIMMERABILE TOUCH  
TOUCH DIMMABLE



ricarica USB USB recharge







Personalizzabile nella colorazione della struttura in alluminio. Queste colorazioni non garantiscono la protezione IP54. Si consiglia l'utilizzo del prodotto in ambienti interni e protetti.

Colour of the aluminium body available upon request. These colour finishes do not guarantee IP54 protection. It is recommended the usage of the product in indoor protected areas.



ORO ARG RA



# TAKE AWAY



Lampada da tavolo a LED RGB + warm white (3000K), portatile e ricaricabile, adatta per utilizzo indoor e outdoor (grado di protezione IP65). Corpo diffondente tondo (emissione di luce diffusa e confortevole) in polietilene bianco opaco con maniglia in similpelle antracite. Accensione on/off con interruttore touch, dimmerabile tramite telecomando. Ricarica tramite USB, durata della batteria 10 ore. LED a 9 colori, con possibilità di luce fissa, alternata (a due velocità regolabili dall'utente) e con variazione colore RGB. Possibilità di selezione del colore del LED e variazione intensità grazie al telecomando multifunzione in dotazione.

LED table lamp RGB + warm white (3000K), portable and rechargeable, ideal for indoor and outdoor applications (protection grade IP65). Round diffuser body (wide and comfortable lighting emission) in matt white polyethylene and handle in anthracite leatherette. ON/OFF touch switch, dimmable with remote control. Rechargeable through a USB cable, battery life 10 hours. LED available in 9 colours, flashing and alternate mode (two speed settings) and RGB colour variability. LED colour selection and light intensity with provided multifunctional remote control.





ricarica USB USB recharge

caricatore USB multiplo a 8 porte cod. MT.8USB (pag. 745)  
8-port multiple multiple USB charger cod. MT.8USB (pag. 745)  
688





**TAE001AN**



LED 3W

RGB + WHITE (3000K) 180 lm

durata life 10 H

ricarica recharge 3-5 H

IP65 CE





# TAKE AWAY SOUND



Lampada da tavolo a LED RGB + warm white (3000K), portatile, ricaricabile e con emissione del suono, adatta per utilizzo indoor e outdoor (grado di protezione IP44). Corpo diffondente in polietilene bianco opaco e maniglia intercambiabile in metallo verniciato (da ordinare separatamente), disponibile in quattro finiture: rosso, giallo, blu e verde. Accensione on/off con interruttore touch, dimmerabile tramite telecomando. Ricarica tramite USB, durata della batteria 10 ore. Dotata di altoparlante Bluetooth collegabile tramite smartphone e tablet. LED a 9 colori, con possibilità di luce fissa, alternata (a due velocità regolabili dall'utente) e con variazione colore RGB. Possibilità di selezione del colore del LED, variazione dell'intensità della luce e controllo del volume grazie al telecomando multifunzione in dotazione.

LED table lamp RGB + warm white (3000K), portable, rechargeable and with sound speaker, ideal for indoor and outdoor applications (protection grade IP44). Body diffuser in matt white polyethylene and interchangeable handle in painted metal (to be ordered separately) available in four finishes: red, yellow, blue and green. ON/OFF touch switch, dimmable via remote control. Rechargeable through a USB cable, battery life 10 hours. Equipped with Bluetooth speaker connectable to smartphone and tablet. LED available in 9 colours, flashing and alternate mode (two speed settings) and RGB colour variability. LED colour selection, light intensity and sound volume setting with provided multifunctional remote control.



**F.TAE**



LED 3W

RGB + WHITE (3000K) 180 lm

durata life 10 H

ricarica recharge 3-5 H

IP44 CE



caricatore USB multiplo a 8 porte cod. MT.8USB (pag. 745) 8-port multiple multiple USB charger cod. MT.8USB (pag. 745)



# WALT



Lampada LED da parete a luce indiretta (3000K) con struttura in pressofusione di alluminio, verniciato con polveri poliestere a elevata resistenza ai raggi ultravioletti e alla corrosione. Possibilità di installazione in ambienti esterni (IP54). Disponibile in due misure e in finitura bianca.

Indirect light wall LED lamp (3000K) with die-cast aluminium structure, painted with polyester powders, highly resistant to UV rays and corrosion. The product can be installed in outdoor environments (IP54). Available in two sizes and in white finish.



**A.10357-5-B**

LED 2,7W

3000K 270 lm



⊕ ⊖ IP54 CE



**A.10357-10-B**

LED 2,7W

3000K 270 lm



⊕ ⊖ IP54 CE





# BIANCA



Lampada decorativa da terra per esterno (IP65), dalla forma sferica o semisferica. Corpo diffondente in polietilene con attacco E27 che consente di montare lampadina LED, per un effetto scenografico di luce diffusa. Per fissarla nel terreno è necessario l'utilizzo dell'apposita controcassa. Disponibile in tre diametri nella versione sferica e in due misure nella versione semisferica.

Decorative outdoor floor lamp with spherical or semi-spherical shape. Polyethylene diffuser with E27 lamp holder that allows mounting the LED lamp, for a scenographic diffused light. The outercasing is necessary to keep it fixed on the ground. Available in three diameters in the spherical version and in two sizes in the semi-spherical version.





Ø 280 / 380 / 550

**T.808-22**

E27 1x75W max - Ø 280 mm



**T.808-38**

E27 1x75W max - Ø 380 mm



**T.808-55**

E27 1x75W max - Ø 550 mm



☐ ▽ IP65 CE



Ø 500 / 750

250 / 380

**T.809-50**

E27 1x75W max - Ø 500 mm



**T.809-75**

E27 1x75W max - Ø 750 mm



☐ ▽ IP65 CE



**MT.808**

Controcassa per fissaggio  
Outercasing for fixing







LAMPADE DA  
BAGNO  
BATHROOM  
LIGHT



# READ



Lampada da parete con LED integrato (3000K), proposta in tre misure e relative potenze. Corpo molto sottile in metallo (alto solo 60mm), proposto in finitura cromata, bianca e nera. Diffusione della luce a 180°, si presta per illuminazione diffusa di specchi e quadri.

Wall LED lamp (3000K). Available in three sizes and related powers. Very thin metal body (only 60mm high) available in chrome, white and black finishes. 180° light diffusion, suitable for mirrors and paintings' lighting.

**REA001**

LED 10W

3000K 900 lm

attacco a parete wall support 150x60x35mm



⊕ ⚡ IP20 CE

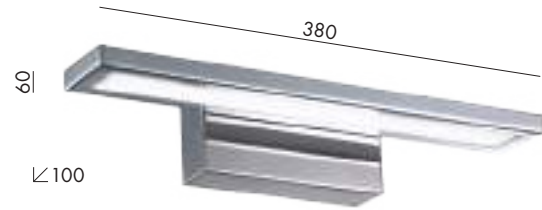

**REA002**

LED 12W

3000K 1100 lm

attacco a parete wall support 150x60x35mm



⊕ ⚡ IP20 CE



**REA003**

LED 20W

3000K 2300 lm

attacco a parete wall support 200x70x35mm



⊕ ⚡ IP20 CE

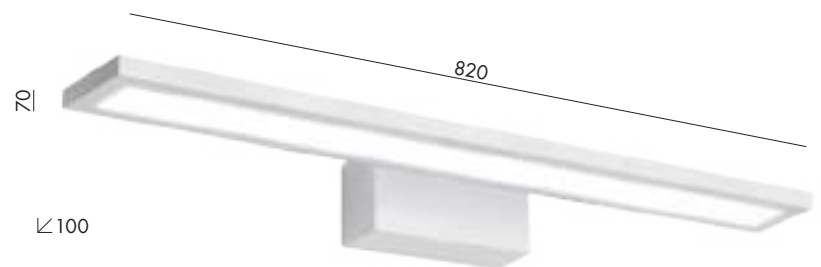

new



# SAYA



Lampada da parete a LED (3000K), proposta in tre misure e relative potenze. Composta da un corpo in metallo dalla forma cilindrica, verniciato nelle finiture bianco, oro satinato e cromo. Braccio che si fissa sull'attacco a parete orientabile di 180°. Si presta per l'illuminazione radente di specchi e quadri.

Wall lamp with integrated LED source (3000K) available in three sizes and related powers. Metal body with a cylindrical shape, available in three finishes: white, satin gold and chrome. Adjustable arm attaching to the wall support (max 180°). It is suitable for oblique lighting of mirrors and paintings.

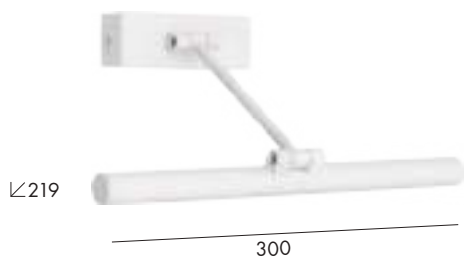

**SAY001**

LED 8W

3000K 600 lm

attacco a parete wall support 115x40x30mm



□ ▽ IP44 CE

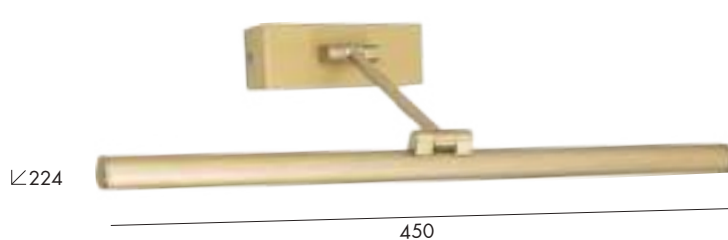

**SAY002**

LED 12W

3000K 950 lm

attacco a parete wall support 125x45x35mm



□ ▽ IP44 CE

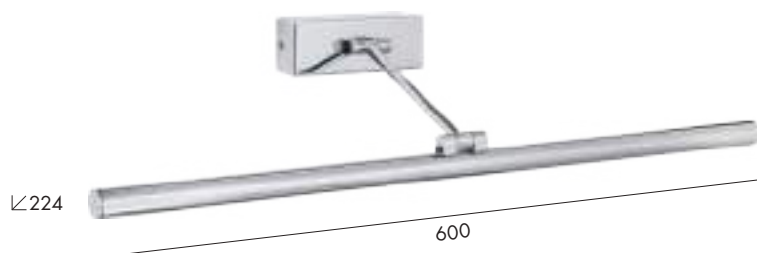

**SAY003**

LED 16W

3000K 1250 lm

attacco a parete wall support 125x45x35mm



□ ▽ IP44 CE



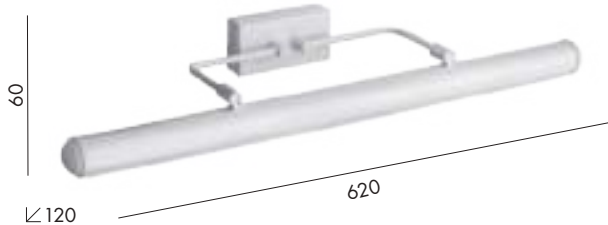

**A.3028**

G9 4x33W max

attacco a parete wall support 80x40x23mm

☐ ▽ IP20 CE

☐ B CR OL



**A.3031**

G9 2x33W max

attacco a parete wall support 80x40x23mm

☐ ▽ IP20 CE

☐ B CR OL



**A.3029**

G9 2x33W max

attacco a parete wall support 80x40x23mm

☐ ▽ IP20 CE

☐ B CR OL



**A.3030**

G9 2x33W max

attacco a parete wall support 80x40x23mm

☐ ▽ IP20 CE

☐ B CR OL

restyle

# TAYLOR



Lampada da parete dal design elegante con struttura in metallo e diffusore orientabile sul proprio asse di 180°. Disponibile in tre finiture: cromo, oro lucido e bianco. Cablata con attacco G9 che consente di montare lampadina LED.

Wall lamp characterised by an elegant design with structure and diffuser adjustable on its axis by 180°. Available in three finishes: chrome, polished gold and white. E27 lamp holder that allows mounting LED lamp.

MADE IN MILANO





**A.4719**

G9 2x33W max

attacco a parete wall support 80x40x25mm

IP20 CE

BZ CR OL

# NEMO



Lampada da parete in ottone, con corpi lampada orientabili di 360°. Disponibile in tre finiture: cromo, oro lucido e bronzo. Cablata con attacco G9 che consente di montare lampadina LED.

Wall brass lamp, with adjustable lamp bodies by 360°. Available in three finishes: chrome, polished gold and bronze. G9 lamp holder that allows mounting LED lamp.



**A.10582**

LED 7W  
3000K 600 lm



IP44 CE

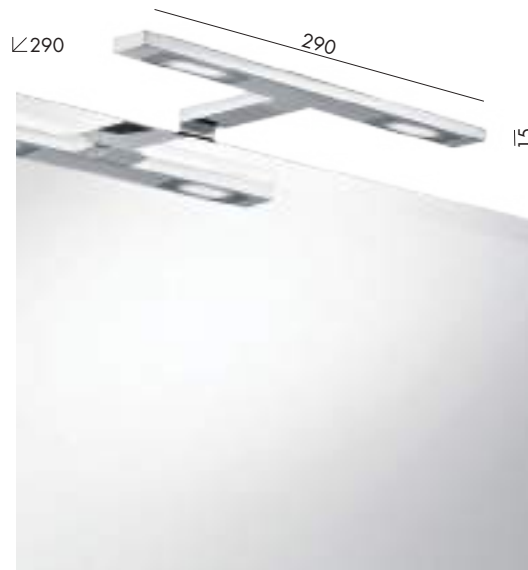

**A.10583**

LED 2x3W  
3000K 550 lm



IP44 CE

# ABIKA



Lampada a LED (3000K) singola o doppia, predisposta per "attacco a piastra" con corpo in metallo cromato. Corredata di alimentatore esterno (da incassare nella struttura dello specchio o in remoto). Deve essere montata direttamente sugli specchi con telaio a filo (es. ZED).

Single or double LED lamp (3000K) set-up for "plate connection" with body in chrome metal. Equipped with remote driver (to be installed in the mirror structure or remotely). It must be mounted directly on mirrors with frame flush (ex. ZED).



# DYLAN



Lampada da parete con struttura in ottone cromato e diffusore in vetro pyrex satinato a copertura della fonte luminosa e per un'ottima diffusione della luce a 360°. Proposta con attacco a parete standard o per fissaggio dietro lo specchio con telaio tradizionale (art. DYLO03). Attacco R7s che consente di montare lampadina LED.

Wall lamp with chrome brass structure and satin pyrex glass diffuser to cover the lamp body and for 360° diffused light emission. Available with standard wall support and support for mounting behind the mirror with traditional frame (DYLO03). R7s lamp holder that allows mounting LED lamp.

MADE IN MILANO

∠ 120



100

315

**DYLO01**

R7s117 1x120W max



⊕ ⊖ IP20 CE

∠ 120



40

315

**DYLO02**

R7s117 1x120W max



⊕ ⊖ IP20 CE

315

∠ 125



125

**DYLO03**

R7s117 1x120W max



⊕ ⊖ IP20 CE

∟ 120 220



**A.4262**

G9 2x33W max

attacco a parete wall support 80x40x35mm



⊕ ⊖ IP20 CE

∟ 130 390



**A.4260**

G9 4x33W max

attacco a parete wall support 250x40x25mm



⊕ ⊖ IP20 CE

# ELONIA



Lampada da parete con struttura in metallo cromato e diffusore in vetro satinato a copertura della fonte luminosa e per un'ottima diffusione della luce. Proposta in due misure e relative potenze, con attacco G9 che consente di montare lampadina LED.

Wall lamp with chrome metal structure and diffuser in satin glass to cover the lamp body, for a diffused light emission. Available in two sizes and related powers, with G9 lamp holder that allows mounting LED lamp.

MADE IN  
MILANO



**A.3026**

G9 2x33W max

attacco a parete wall support 80x40x20mm



⊕ ⊖ IP20 CE

GR CR

# PIPER



Lampada da parete in metallo cromato o verniciato grigio e diffusore cilindrico in vetro satinato per un'ottima diffusione della luce. Cablata con attacco G9 che consente di montare lampadina LED.

Wall lamp in chrome or grey painted metal and cylindrical diffuser in satin glass, for a diffused light emission G9 lamp holder that allows mounting LED lamp.



**5041-60-LED**

LED 12W  
3000K 1000 lm



IP65 CE



**5042-LED**

LED 12W  
3000K 1000 lm



IP65 CE

# ALTEA



Specchio con illuminazione molato a 45°. Fissaggio a parete a scomparsa. Dotato di corpi illuminanti a LED (3000K), la cui luce fuoriesce dalle parti acidate dello specchio. Proposto in versione quadrata e rettangolare.

45° bevelled mirror with light. Framless wall mounting. Featuring LED lighting (3000K) that is emitted through the etched parts of the mirror. Available in rectangular or square shape.



Ø 600

**5043**

LED 12W  
3000K 1000 lm



IP65 CE



Ø 600

**5015-60**

Specchio senza fonte luminosa  
Decorative round mirror without  
light source



TELAIO A PIASTRA  
PLATE FRAME

# BLUMEA



Specchio tondo molato a 45°. Fissaggio a parete con telaio tradizionale a scomparsa. Proposto nella versione con luce a LED (l'illuminazione fuoriesce dalle parti acidate dello specchio) o solo specchio.

45° bevelled round mirror. Wall mounted with concealed traditional frame. Available in the version with light (LED lighting is emitted through the etched parts of the mirror) or in the version with only mirror.



# ZED



Specchio molato a 45° con spessore di 4 mm con o senza luce. Fissaggio a parete con telaio tradizionale a scomparsa. La versione con luce è retroilluminata con luce a LED (3000K) che esce dal lato superiore e inferiore dello specchio. Proposto in versione quadrata o rettangolare.

45° bevelled mirror with 4 mm thickness. Available in the backlit version with LED light, or only mirror. Wall mounted with concealed traditional frame. The LED version (3000K) features backlight at the top and bottom. Available in square or rectangular shape.



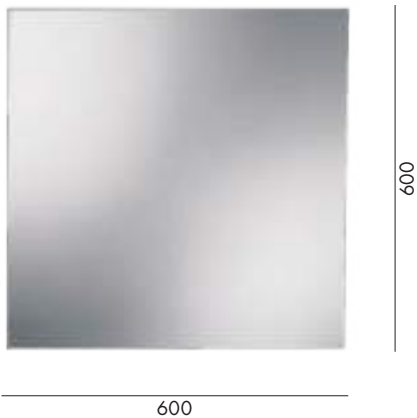

**5026-60-LED**

LED 16W  
3000K 1000 lm



□ ▽ IP65 CE

**5026-60**

Specchio senza fonte luminosa  
Decorative mirror without light source



TELAIO TRADIZIONALE  
TRADITIONAL FRAME

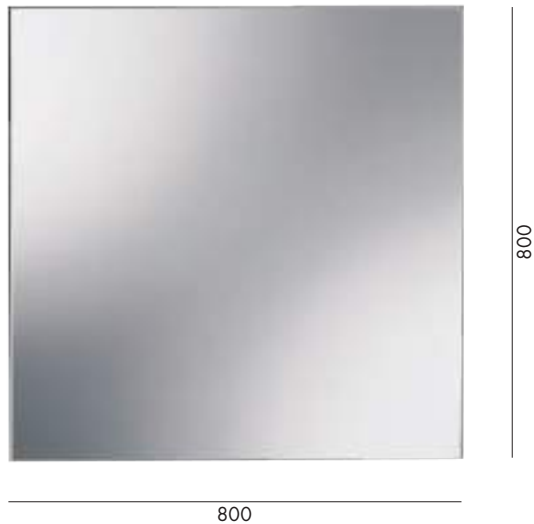

**5026-80-LED**

LED 16W  
3000K 1000 lm



□ ▽ IP65 CE

**5026-80**

Specchio senza fonte luminosa  
Decorative mirror without light source



TELAIO TRADIZIONALE  
TRADITIONAL FRAME



**5028-LED**

LED 16W  
3000K 1000 lm



□ ▽ IP65 CE

**5028**

Specchio senza fonte luminosa  
Decorative mirror without light source



TELAIO TRADIZIONALE  
TRADITIONAL FRAME





VENTILATORI  
PADDLE FAN



**GRE001**

LED 12W

3000K 1100 lm

motore engine DC 35W

rosone ceiling rose Ø 150x60mm



IP20 CE



new

# GRECALE



Ventilatore a soffitto a LED (3000K) con cinque pale in legno verniciato grigio o bianco e struttura in alluminio grigio o bianco. Dotato di telecomando a onde radio per la regolazione della velocità, invertitore di marcia estate-inverno e accensione-spegnimento della luce.

LED ceiling fan (3000K) with five blades in grey or white painted wood and grey or white aluminium structure. Equipped with a radio wave remote control for speed adjustment, summer-winter reversing switch and light switch.



**MET001**

LED 12W  
3000K 1100 lm

motore engine AC 70W  
rosone ceiling rose Ø 150x60mm



IP20 CE



# MELTEMI



Ventilatore a soffitto a LED (3000K) con quattro pale in legno verniciato bianco o grigio e struttura in alluminio cromato scuro. Dotato di telecomando a onde radio per la regolazione della velocità e accensione-spegnimento della luce.

LED ceiling fan (3000K) with four blades in white or grey painted wood, structure in dark chrome aluminum. Equipped with a radio wave remote control for speed adjustment and light switch.

new



# ELENA



Ventilatore a soffitto a due, tre e quattro pale in metallo cromato per la versione con struttura cromo, in acrilico trasparente per la versione con struttura bianca. Con regolatore a parete e invertitore di marcia estate-inverno. Non dotato di illuminazione.

Ceiling fan available with two, three or four blades, in chrome finish for the version with chrome structure, in clear acrylic for the version with white structure. With wall regulator and summer-winter reversing switch. Not equipped with lighting.

7560

motore engine 60W  
rosone ceiling rose Ø130x60mm

⊕ ⊖ IP20 CE

B CR

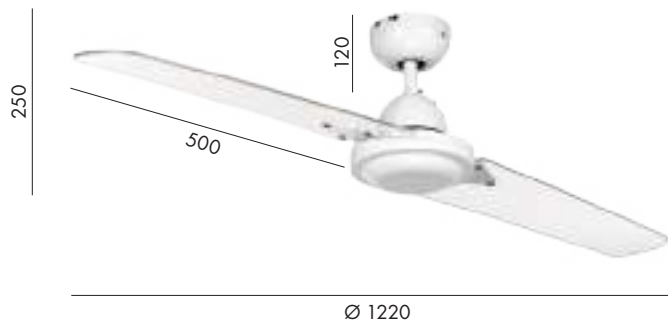

7561

motore engine 60W  
rosone ceiling rose Ø130x60mm

⊕ ⊖ IP20 CE

B CR

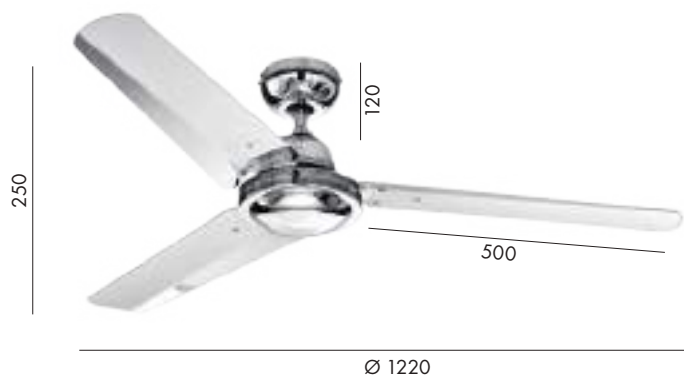

7562

motore engine 60W  
rosone ceiling rose Ø130x60mm

⊕ ⊖ IP20 CE

B CR

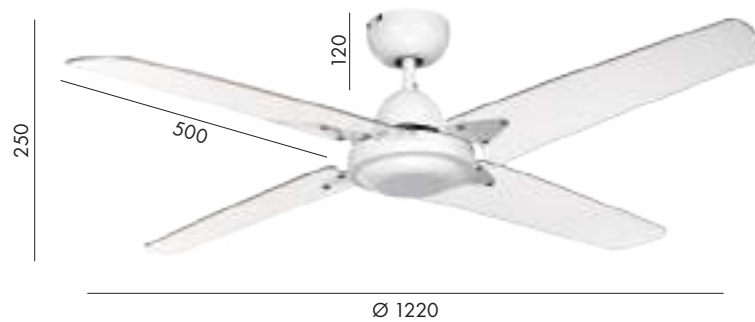



# TRICIA



Ventilatore a soffitto dallo stile classico a quattro pale in legno con inserti in paglia di Vienna e tazze portalampada in vetro. Struttura in due finiture: bianco e bronzo. Invertitore di marcia estate-inverno. Predisposto per telecomando a infrarossi da acquistare separatamente (cod. 7570) o accensione e regolazione della velocità tramite corda tiretto.

Four-blade wood ceiling fan in classic style, with internal part in Vienna straw and glass lamp holder cups. Structure in two finishes: white and bronze. Summer-winter reversing switch. Set-up for infrared remote control to be purchased separately (code 7570) or activation and speed adjustment through pull-cord.



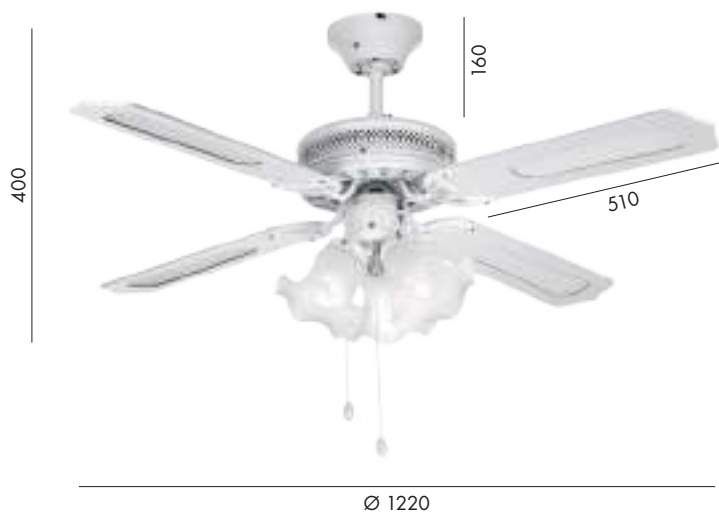

**7567**

E14 3x40W max

motore engine 60W

rosone ceiling rose Ø 130x60mm



⊕ ⊖ IP20 CE

B BZ

**7570**

Telecomando ad infrarossi

Infrared remote control





ACCESSORI  
ACCESSORIES

# LAMPADINE LED VINTAGE VINTAGE LED BULBS



L.291-5



L.281-5-C



L.282-5-C

Codice Code	Finitura Finishing	Watt	Volt	⚡	K	Dimensioni Dimension	Flusso Flux	Fascio Beam angle
<b>D</b> L.291-5	oro gold	5	230	E27	2000	Ø200 x H.180	250 lm	360°
L.281-5-C	oro gold	5	230	E27	2000	Ø125 x H.160	150 lm	360°
L.282-5-C	oro gold	5	230	E27	2000	Ø125 x H.175	250 lm	360°



L.292-5-GOLD



L.292-5-FU



L.292-5-V

Codice Code	Finitura Finishing	Watt	Volt	⚡	K	Dimensioni Dimension	Flusso Flux	Fascio Beam angle
<b>D</b> L.292-5-GOLD	oro gold	5	230	E27	2000	Ø165 x H.300	250 lm	360°
<b>D</b> L.292-5-FU	fumè smoked	5	230	E27	2000	Ø165 x H.300	250 lm	360°
<b>D</b> L.292-5-V	verde green	5	230	E27	2000	Ø165 x H.300	250 lm	360°



L.293-5-GOLD



L.293-5-FU



L.293-5-V

Codice Code	Finitura Finishing	Watt	Volt	⚡	K	Dimensioni Dimension	Flusso Flux	Fascio Beam angle
<b>D</b> L.293-5-GOLD	oro gold	5	230	E27	2000	Ø200 x H.300	250 lm	360°
<b>D</b> L.293-5-FU	fumè smoked	5	230	E27	2000	Ø200 x H.300	250 lm	360°
<b>D</b> L.293-5-V	verde green	5	230	E27	2000	Ø200 x H.300	250 lm	360°

## LAMPADINE LED VINTAGE VINTAGE LED BULBS



**L.294-5-GOLD**



**L.294-5-FU**

Codice Code	Finitura Finishing	Watt	Volt	⚡	K	Dimensioni Dimension	Flusso Flux	Fascio Beam angle
<b>L.294-5-GOLD</b>	oro gold	5	230	E27	2000	Ø 165 x H.300	250 lm	360°
<b>L.294-5-FU</b>	fumè smoked	5	230	E27	2000	Ø 165 x H.300	250 lm	360°



**L.289-5-AM**



**L.289-5-FU**

Codice Code	Finitura Finishing	Watt	Volt	⚡	K	Dimensioni Dimension	Flusso Flux	Fascio Beam angle
<b>L.289-5-AM</b>	oro gold	5	230	E27	2000	Ø 125 x H.175	250 lm	360°
<b>L.289-5-FU</b>	fumè smoked	5	230	E27	2000	Ø 125 x H.175	250 lm	360°



**L.295-10-GOLD**



**L.296-10-GOLD**



**L.297-10-GOLD**

Codice Code	Finitura Finishing	Watt	Volt	⚡	K	Dimensioni Dimension	Flusso Flux	Fascio Beam angle
<b>L.295-10-GOLD</b>	oro gold	11	230	E27	2000	Ø 180 x H.365	250 lm	360°
<b>L.296-10-GOLD</b>	oro gold	11	230	E27	2000	Ø 120 x H.440	250 lm	360°
<b>L.297-10-GOLD</b>	oro gold	11	230	E27	2000	Ø 75 x H.315	250 lm	360°

## LAMPADINE LED VINTAGE VINTAGE LED BULBS





**L.283-12-4**



**L.284-12-4**



**L.285-12-4**

Codice Code	Finitura Finishing	Watt	Volt	⌚	K	Dimensioni Dimension	Flusso Flux	Fascio Beam angle
 <b>L.283-12-4</b>	oro gold	8	230	E27	2200	Ø 125 x H.175	280 lm	360°
 <b>L.284-12-4</b>	oro gold	8	230	E27	2200	Ø 95 x H.138	280 lm	360°
 <b>L.285-12-4</b>	oro gold	8	230	E27	2200	Ø 64 x H.145	280 lm	360°



**L.959-12-4**



**L.260-12-4**







**L.266-12-4**



**L.287-12-4**



**L.278-12-4**

Codice Code	Finitura Finishing	Watt	Volt	⌚	K	Dimensioni Dimension	Flusso Flux	Fascio Beam angle
 <b>L.959-12-4</b>	oro gold	8	230	E27	2200	Ø 65 x H.120	600 lm	360°
 <b>L.260-12-4</b>	oro gold	4	230	E27	2200	Ø 65 x H.120	300 lm	360°
 <b>L.266-12-4</b>	oro gold	4	230	E14	2200	Ø 65 x H.120	300 lm	360°
 <b>L.287-12-4</b>	oro gold	4	230	E14	2200	Ø 35 x H.125	300 lm	360°
 <b>L.278-12-4</b>	oro gold	4	230	E14	2200	Ø 35 x H.100	300 lm	360°





**L.283-5-FU**



**L.284-5-FU**



**L.285-5-FU**

Codice Code	Finitura Finishing	Watt	Volt	⌚	K	Dimensioni Dimension	Flusso Flux	Fascio Beam angle
 <b>L.283-5-FU</b>	fumè smoked	5	230	E27	2200	Ø 125 x H.175	280 lm	360°
 <b>L.284-5-FU</b>	fumè smoked	5	230	E27	2200	Ø 95 x H.138	280 lm	360°
 <b>L.285-5-FU</b>	fumè smoked	5	230	E27	2200	Ø 64 x H.145	280 lm	360°

## LAMPADINE LED VINTAGE VINTAGE LED BULBS







**L.283-5-V**



**L.284-5-V**



**L.285-5-V**

Codice Code	Finitura Finishing	Watt	Volt		K	Dimensioni Dimension	Flusso Flux	Fascio Beam angle
 <b>L.283-5-V</b>	verde green	5	230	E27	2200	Ø 125 x H.175	280 lm	360°
 <b>L.284-5-V</b>	verde green	5	230	E27	2200	Ø 95 x H.138	280 lm	360°
 <b>L.285-5-V</b>	verde green	5	230	E27	2200	Ø 64 x H.145	280 lm	360°

## LAMPADINE LED CROMATE CHROME LED BULBS







**L.283-13-1**



**L.284-13-1**



**L.959-13-1**

Codice Code	Finitura Finishing	Watt	Volt		K	Dimensioni Dimension	Flusso Flux	Fascio Beam angle
 <b>L.283-13-1</b>	cromo chrome	7	230	E27	2700	Ø 125 x H.175	806 lm	180°
 <b>L.284-13-1</b>	cromo chrome	7	230	E27	2700	Ø 95 x H.135	806 lm	180°
 <b>L.959-13-1</b>	cromo chrome	7	230	E27	2700	Ø 60 x H.108	806 lm	180°

## LAMPADINE LED TRASPARENTI CLEAR LED BULBS





**L.283-10-1**



**L.284-10-1**



**L.285-10-1**

Codice Code	Finitura Finishing	Watt	Volt	⌚	K	Dimensioni Dimension	Flusso Flux	Fascio Beam angle
 <b>L.283-10-1</b>	trasparente clear	8	230	E27	2700	Ø 125 x H.175	800 lm	360°
 <b>L.284-10-1</b>	trasparente clear	8	230	E27	2700	Ø 95 x H.138	800 lm	360°
 <b>L.285-10-1</b>	trasparente clear	8	230	E27	2700	Ø 64 x H.145	800 lm	360°



**L.959-10-1**



**L.260-10-1**



**L.266-10-1**



**L.287-10-1**







**L.278-10-1**



**L.286-4-C**



**L.48-2**

Codice Code	Finitura Finishing	Watt	Volt	⌚	K	Dimensioni Dimension	Flusso Flux	Fascio Beam angle
 <b>L.959-10-1</b>	trasparente clear	8	230	E27	2700	Ø 65 x H.175	800 lm	360°
 <b>L.260-10-1</b>	trasparente clear	4	230	E27	2700	Ø 45 x H.82	400 lm	360°
 <b>L.266-10-1</b>	trasparente clear	4	230	E14	2700	Ø 45 x H.82	400 lm	360°
 <b>L.287-10-1</b>	trasparente clear	4	230	E14	2700	Ø 35 x H.125	400 lm	360°
 <b>L.278-10-1</b>	trasparente clear	4	230	E14	2700	Ø 35 x H.100	400 lm	360°
<b>L.286-4-C</b>	trasparente clear	4	230	E14	3000	Ø 35 x H.100	380 lm	360°
<b>L.48-2</b>	trasparente clear	2	230	E14	2700	Ø 25 x H.63	250 lm	360°



# LAMPADINE LED BIANCHE WHITE LED BULBS



L.283-11-1



L.284-11-1



L.285-11-1



L.8113-9-F



L.282-21-C



L.283-6-OP-2K

Codice Code	Finitura Finishing	Watt	Volt	U	K	Dimensioni Dimension	Flusso Flux	Fascio Beam angle
L.283-11-1	bianco white	8	230	E27	2700	Ø 125 x H.175	650 lm	360°
L.284-11-1	bianco white	8	230	E27	2700	Ø 95 x H.138	650 lm	360°
L.285-11-1	bianco white	8	230	E27	2700	Ø 64 x H.145	650 lm	360°
L.282-21-C	bianco white	21	230	E27	3000	Ø 120 x H.158	1900 lm	220°
L.8113-9-F	bianco white	9	230	E27	4000	Ø 95 x H.130	700 lm	270°
L.283-6-OP-2K ceramica ceramic	bianco white	6	230	E27	2700	Ø 155 x H.200	540 lm	360°



L.959-11-1



L.959-12-C  
L.959-16-C



L.927-LED



L.959-9-RGB



L.260-6-C



L.266-6-C



L.271-3,5

Codice Code	Finitura Finishing	Watt	Volt	U	K	Dimensioni Dimension	Flusso Flux	Fascio Beam angle
L.959-11-1	bianco white	8	230	E27	2700	Ø 65 x H.120	650 lm	360°
L.959-12-C	bianco white	12	230	E27	3000	Ø 65 x H.120	1100 lm	220°
L.959-16-C	bianco white	16	230	E27	3000	Ø 75 x H.140	1520 lm	220°
L.927-LED con sensore crepuscolare with twilight sensor	bianco white	9	230	E27	3000	Ø 60 x H.110	800 lm	220°
L.959-9-RGB con telecomando with remote control	bianco white	9	230	E27	RGB+W 6000K	Ø 60 x H.122	720 lm	220°
L.260-6-C	bianco white	6	230	E27	3000	Ø 45 x H.78	600 lm	200°
L.266-6-C	bianco white	6	230	E14	3000	Ø 45 x H.82	600 lm	200°
L.271-3,5	bianco white	3,5	230	E14	3000	Ø 45 x H.110	250 lm	200°

## LAMPADINE LED CON TECNOLOGIA SMART SMART LED BULBS



L.283-6-27K-WF



L.959-6-27K-WF



Codice Code	Finitura Finishing	Watt	Volt	⌚	K	Dimensioni Dimension	Flusso Flux	Fascio Beam angle
L.283-6-27K-WF	trasparente transparent	6	230	E27	2700	Ø125 x H.175	700 lm	360°
L.959-6-27K-WF	trasparente transparent	6	230	E27	2700	Ø60 x H.114	700 lm	360°



MT.SWIWF

### SMART WIFI SWITCH

Interruttore intelligente compatibile con Alexa e Google Home per apparecchiature elettriche wifi da 2.4 GHz, che fornisce agli utenti un controllo intelligente della casa. Carico Max 500W.

Smart switch compatible with Alexa and Google Home for 2.4 GHz wifi electrical equipment, which provides users with intelligent home control. Max load 500W.



MT.SHUWF

### SMART WIFI SHUKO SWITCH

Presse intelligente wireless compatibile con Alexa e Google Home per qualsiasi dispositivo elettrico standard. Comanda fino a 2200W con controllo vocale e funziona con qualsiasi router wifi 2.4 GHz

Smart wireless socket compatible with Alexa and Google Home for any standard electrical device. It controls up to 2200W with voice control and works with any 2.4 GHz wifi router.

TABELLA COMPATIBILITÀ LAMPADINE CON TECNOLOGIA SMART COMPATIBILITY TABLE BULBS WITH SMART TECHNOLOGY

FAMIGLIA FAMILY			FAMIGLIA FAMILY			FAMIGLIA FAMILY		
L.283-6-27K-WF	L.959-6-27K-WF		L.283-6-27K-WF	L.959-6-27K-WF		L.283-6-27K-WF	L.959-6-27K-WF	
AISHA		AIS001	ERKEL	ERK101	ERK101	MILLA		A.3425
AISHA		AIS002	ERKEL	ERK103	ERK103	MILLA	3424-B	
AISHA		AIS003	ERKEL	ERK105	ERK105	MILLA	T.3424-B	
ASIA		ASI001	GLORIA	10850-20		MINX		2597-12
ASIA		ASI002	GLORIA		10850-30	MINX		2597-3
BEK	794-30		GLORIA		A.10850-20	MINX		2597-6
BEK	794-40		GLORIA		A.10850-30	MINX		2598-3
BELL	BELO01		GLORIA		P.10850-30	MINX		2598-6
BELL	BELO02		GLORIA		P.10850-40	MINX		A.2598-1
BESANA		BES001	GLORIA		T.10850	MINX		A.2598-3
BESANA	BES002		GRIP	T.2135		NERELLO		NER001
BESANA		BES003	HOLLY		3868-30	OFU	OFU001	
BESANA	BES004		HOLLY		3868-45	PEGGY	PEG001	
BINNIE		10118-20	HOLLY		A.3867-20	PIAF	3485-40	
BINNIE		10118-30	HOLLY		A.3867-30	PIAF	3485-55	
BRENDA		10501-35	HOLLY		P.3867	PIAF		PIA001SAT
BRENDA		10501-45	HOLLY		T.3867	PIAF		PIA002SAT
BYRON		BYR001	INGRID		10106-20	RUNAK		RUN001
BYRON		BYR002	INGRID		10106-25	RUNAK		RUN002
BYRON	BYR003		INGRID	10106-35		RUNAK		RUN003
BYRON	BYR004		INGRID		A.10106	RUNAK		RUN004
BYRON	BYR004		ISAKO	10801-40		SALLY	SAL001	
BYRON		BYR005	ISAKO	10801-50		SALLY	SAL002	
BYRON		BYR006	JAY	JAY001	JAY001	SANCHO		SAN001
BYRON		BYR007	JAY	JAY002	JAY002	SANCHO		SAN002
BYRON	T.10760		KARAOKE	KAR001	KAR001	SANCHO		SAN005
CARRIE		CAR001	KARAOKE	KAR002	KAR002	SHELL		SHE001
CARRIE		CAR002	KARAOKE	KAR003	KAR003	SHELL		SHE002
CARRIE		CAR003	KARAOKE	KAR004	KAR004	SHELL		SHE003
CLAIRE	S.10570-35		KARAOKE	KAR005	KAR005	SHELL		SHE004
CLAIRE		S.10570-45	KAREN	9401	9401	SOPHIA		2596-20
CLAIRE	T.10570		KAREN	9402	9402	SOPHIA		2596-40
CLAIRE		CLA001	KAREN	9403	9403	SOPHIA		A.2596-40
DRAW		3218	KAREN	9404	9404	SOPHIA		SOP001
DRAW		P.3218-20	KAREN	9405	9405	TWIN	TWI001	TWI001
DRAW		P.3218-30	KAREN	9406	9406	TWIN	TWI002	TWI002
DRAW	T.3218		KAREN	A.9407	A.9407	TWIN	TWI003	TWI003
EMILY		5487-20	KAREN	A.9408	A.9408	TWIN	TWI004	TWI004
EMILY		5487-30	KAREN	A.9409	A.9409	TWIN	TWI005	TWI005
EMILY	5487-40		LEIKA	LEK001	LEK001	VIVIEN		10770-60
EMILY		5488-20	LUKE	9530		VIVIEN	10771-50	
EMILY		5488-30	LUKE	9531		VIVIEN		10771-60
EMILY	5488-40		LUKE		A.9521	VIVIEN		A.10770
EMILY		P.5488-20	LUKE		A.9522	VIVIEN	10771	
EMILY		P.5488-30	MARILYN	10455-35		VIVIEN		P.10770-40
EMILY	P.5488-40		MARILYN	10455-50		VIVIEN	T.10770	
EMILY		EMI002	MARILYN	S.10455-35		WANG	WAN001	WAN001
EMILY	EMI003		MARILYN	S.10455-50				
EMILY		EMI004	MARILYN	P.10455-35				
EMILY	EMI005		MEG	MEG001				
EMPTY	EMPO01	EMPO01	MILLA		A.3424-30			

## LAMPADINE LED LED BULBS

LED GU10	Codice Code	Watt	Volt	Attacco Lamp holder	Dimensioni Dimension	Descrizione Description
	 L.263-7-DIM-B	7	230	GU10	Ø50 - H.51	450 lm - 35° - 2700K
	 L.264-7-C-DIM-B	7	230	GU10	Ø50 - H.51	530 lm - 35° - 3000K
	 L.265-7-DIM-B	7	230	GU10	Ø50 - H.51	600 lm - 35° - 4000K
	 L.264-7-C-DIM	7	230	GU10	Ø50 - H.51	530 lm - 35° - 3000K
	 L.264-7-F-DIM	7	230	GU10	Ø50 - H.51	567 lm - 35° - 4000K
	L.273-5-2K	5	230	GU10	Ø50 - H.60	335 lm - 38° - 2700K
	L.273-5	5	230	GU10	Ø50 - H.60	345 lm - 38° - 3000K
	L.273-5-4K	5	230	GU10	Ø50 - H.90	355 lm - 38° - 4000K
	L.272-7-2K	7	230	GU10	Ø50 - H.51	450 lm - 120° - 2700K
	L.272-7-3K	7	230	GU10	Ø50 - H.51	530 lm - 120° - 3000K
	L.272-7-4K	7	230	GU10	Ø50 - H.51	600 lm - 120° - 4000K
	L.264-5-RGB	3	230	GU10	Ø50 - H.57	RGB con telecomando 
	● L.264-C-8	3	230	GU10	Ø50 - H.60	265 lm - 8° - 3000K
	● L.264-F-30	3	230	GU10	Ø50 - H.60	280 lm - 30° - 4000K
	● L.264-F-8	3	230	GU10	Ø50 - H.60	280 lm - 8° - 4000K
	● L.957-9-F	9	230	GU10	Ø50 - H.90	380 lm - 4000K
	L.255-3-C	3	230	GU10	Ø35 - H.48	200 lm - 40° - 3000K
<b>LED DICROICA GU5,3</b>						
	L.257-5-C	5	12	GU5,3	Ø50 - H.51	320 lm - 3000K
	● L.257-C-30	3	12	GU5,3	Ø50 - H.52	265 lm - 30° - 3000K
	● L.257-C-8	3	12	GU5,3	Ø50 - H.52	265 lm - 8° - 3000K
	● L.257-F-30	3	12	GU5,3	Ø50 - H.52	280 lm - 30° - 4000K
	● L.257-F-8	3	12	GU5,3	Ø50 - H.52	280 lm - 8° - 4000K
	● L.274-4-F	4	12	GU5,3	Ø50 - H.46	280 lm - 30° - 4000K
<b>LED GX53</b>						
	 L.269-7-2K	7	230/240	GX53	Ø75 - H.23	600 lm - 100° - 2700K
	L.269-8-C	8	230/240	GX53	Ø75 - H.23	620 lm - 100° - 3000K
	L.269-8-F	8	230/240	GX53	Ø75 - H.23	680 lm - 100° - 4000K

## LAMPADINE LED LED BULBS

LED AR111	Codice Code	Watt	Volt	Attacco Lamp holder	Dimensioni Dimension	Descrizione Description
	<b>L.202-15-C-LED</b>	15	230	G53	Ø110- H.73	1300 lm - 60° - 3000K
	<b>L.202-12-C-LED</b>	12	12	G53	Ø111- H.60	865 lm - 25° - 3000K
	<b>L.202-12-F-LED</b>	12	12	G53	Ø111- H.60	910 lm - 25° - 4000K
	<b>L.203-12-C</b>	12	12	GU10	Ø111- H.63	810 lm - 30° - 3000K
	<b>L.203-12-F</b>	12	12	GU10	Ø111- H.63	900 lm - 30° - 4000K
<b>LED G9</b>						
	<b>L.275-10-1</b>	2	230	G9	Ø12- H.60	190 lm - 360° - 2700K
	<b>L.275-10-2</b>	2	230	G9	Ø12- H.60	200 lm - 360° - 3000K
	<b>L.275-10-3</b>	2	230	G9	Ø12- H.60	210 lm - 360° - 4000K
	<b>L.275-11-1</b>	4	230	G9	Ø12- H.60	470 lm - 360° - 2700K
<b>LED G4</b>						
	<b>L.815-10-1</b>	2	12	G4	Ø12- H.35	170 lm - 300° - 2700K
<b>LED R7s</b>						
	<b>L.320-10-C-LED</b>	10	230	R7s 117	Ø28- L.118	760 lm - 3000K
	<b>L.320-10-F-LED</b>	10	230	R7s 117	Ø28- L.118	800 lm - 4000K
	<b>L.320-10-1</b>	10	230	R7s 117	Ø13,5- L.118	1100 lm - 360° - 2700K
	<b>L.379-10-1</b>	4	230	R7s78	Ø13,5- L.78	450 lm - 360° - 2700K
<b>LED REFLECTOR</b>						
	 <b>L.56-4-LED-C</b>	4	230	E14	Ø50- H.86	330 lm - R50 - 2700K
	 <b>L.57-5-LED-C</b>	5	230	E27	Ø63- H.100	400 lm - R63 - 2700K
	 <b>L.58-7-LED-C</b>	7	230	E27	Ø80- H.110	600 lm - R80 - 2700K

## LAMPADINE LED LED BULBS

<b>LED PAR 30</b>	Codice Code	Watt	Volt	Attacco Lamp holder	Dimensioni Dimension	Descrizione Description
	<b>L.258-11-C</b>	11	230	E27	Ø95- H.96	863 lm - 36° - 3000K

## TUBI LED LINEARI LED TUBE



### *SERIE LED T8*

<b>L.510-10-3K</b>	10			G13	Ø26- H.600	810 lm - 260° - 3000K
<b>L.510-10-4K</b>	10			G13	Ø26- H.600	855 lm - 260° - 4000K
<b>L.510-10-6K</b>	10			G13	Ø26- H.600	900 lm - 260° - 6400K
<b>L.510-18-3K</b>	18			G13	Ø26- H.1200	1625 lm - 260° - 3000K
<b>L.510-18-4K</b>	18			G13	Ø26- H.1200	1710 lm - 260° - 4000K
<b>L.510-18-6K</b>	18			G13	Ø26- H.1200	1800 lm - 260° - 6400K
<b>L.510-25-3K</b>	25			G13	Ø26- H.1500	2160 lm - 260° - 3000K
<b>L.510-25-4K</b>	25			G13	Ø26- H.1500	2280 lm - 260° - 4000K
<b>L.510-25-6K</b>	25			G13	Ø26- H.1500	2400 lm - 260° - 6400K

## LED CIRCOLINA LED CIRCULAR BULB





<b>L.500-LED</b>	20	230/240		G10q	Ø300	1600 lm - 360° - 3000K
------------------	----	---------	--	------	------	------------------------

ALOGENA GU10	Codice Code	Watt	Volt	Attacco Lamp holder	Dimensioni Dimension	Descrizione Description
	• L.222-40	40	230	GU10	Ø50- L.55	dicroica 25° dichroic 25°
	• L.223-50	50	230	GZ10	Ø50- L.50	dicroica 25° dichroic 25°

ALOGENA "HALOSPOT" AR111	Codice Code	Watt	Volt	Attacco Lamp holder	Dimensioni Dimension	Descrizione Description
	• L.205-35-6	35	12	G53	Ø111- L.58	fascio 6° beam 6°

ALOGENA BISPINA G9	Codice Code	Watt	Volt	Attacco Lamp holder	Dimensioni Dimension	Descrizione Description
	• L.213-100	100	230	G9	Ø14- L.51	trasparente transparent

ALOGENA BISPINA	Codice Code	Watt	Volt	Attacco Lamp holder	Dimensioni Dimension	Descrizione Description
	• L.212-35	35	12	GY6,35	Ø12- L.44	trasparente12V transparent 12V
	• L.212-50	50	12	GY6,35	Ø12- L.44	trasparente12V transparent 12V

ALOGENA LINEARE LINEAR HALOGEN	Codice Code	Watt	Volt	Attacco Lamp holder	Dimensioni Dimension	Descrizione Description
	L.379-48	48	230	R7s78	L.78	
	L.379-80	80	230	R7s78	L.78	
	L.379-120	120	230	R7s78	L.78	
	L.379-200	200	230	R7s78	L.78	
	L.320-80	80	230	R7s117	L.117	
	L.320-120	120	230	R7s117	L.117	
	L.320-160	160	230	R7s117	L.117	
	L.320-240	240	230	R7s117	L.117	
	L.320-400	400	230	R7s117	L.117	

VETRO DI PROTEZIONE PER ALOGENE LINEARI PROTECTION GLASS FOR LINEAR HALOGEN	Codice Code	Attacco Lamp holder	Dimensioni Dimension
	V.117-CRI	R7s	L.117
	V.178-CRI	R7s	L.78

REFLEX O REFLECTOR	Codice Code	Watt	Volt	Attacco Lamp holder	Dimensioni Dimension	Descrizione Description
	• L.57-28	28	230	E27	Ø63- L. 104	R63
	• L.58-28	28	230	E27	Ø80- L. 110	R80

GOCCIA	Codice Code	Watt	Volt	Attacco Lamp holder	Dimensioni Dimension	Descrizione Description
	L.10-28	28	230	E27	Ø60- L. 105	trasparente transparent
	L.10-42	42	230	E27	Ø60- L. 105	trasparente transparent
	L.10-70	70	230	E27	Ø60- L. 105	trasparente transparent
	L.10-105	105	230	E27	Ø60- L. 105	trasparente transparent

OLIVA	Codice Code	Watt	Volt	Attacco Lamp holder	Dimensioni Dimension	Descrizione Description
	L.18-18	18	230	E14	Ø35- L. 100	trasparente transparent
	L.18-28	28	230	E14	Ø35- L. 100	trasparente transparent
	L.18-42	42	230	E14	Ø35- L. 100	trasparente transparent
	• L.31-25	25	230	E14	Ø35- L. 100	trasparente transparent
	• L.31-40	40	230	E14	Ø35- L. 100	trasparente transparent
	• L.31-60	60	230	E14	Ø35- L. 100	trasparente transparent

TORTIGLIONE	Codice Code	Watt	Volt	Attacco Lamp holder	Dimensioni Dimension	Descrizione Description
	• L.19-28	28	230	E14	Ø35- L. 100	trasparente transparent

SFERA	Codice Code	Watt	Volt	Attacco Lamp holder	Dimensioni Dimension	Descrizione Description
	• L.11-15	15	230	E14	Ø45- L. 76	trasparente transparent
	• L.11-25	25	230	E14	Ø45- L. 76	trasparente transparent
	L.24-18	18	230	E14	Ø45- L. 76	trasparente transparent
	L.24-28	28	230	E14	Ø45- L. 76	trasparente transparent
	L.24-42	42	230	E14	Ø45- L. 76	trasparente transparent
	L.25-18	18	230	E27	Ø45- L. 76	trasparente transparent
	L.25-28	28	230	E27	Ø45- L. 76	trasparente transparent
	L.25-42	42	230	E27	Ø45- L. 76	trasparente transparent



# LAMPADINE FLUORESCENTI COMPATTE INTEGRATE COMPACT FLUORESCENT INTEGRATED BULBS

FLUO REFLECTOR GU10	Codice Code	Watt	Volt	Attacco Lamp holder	Dimensioni Dimension	Descrizione Description
	• L.268-9-C	9	230	GU10	Ø50- L.56	3000K
	• L.268-9-F	9	230	GU10	Ø50- L.56	4000K
	• L.811-7-C	7	230	GU10	Ø50- L.70	3000K
	• L.811-7-F	7	230	GU10	Ø50- L.70	4000K
	• L.811-9-C	9	230	GU10	Ø50- L.76	3000K
	• L.811-9-F	9	230	GU10	Ø50- L.76	4000K
	• L.8111-11-C	11	230	GU10	Ø50- L.75	3000K
	• L.8111-11-F	11	230	GU10	Ø50- L.75	4000K
	• L.8111-13-C	13	230	GU10	Ø50- L.75	3000K
	• L.8111-13-F	13	230	GU10	Ø50- L.75	4000K
	• L.8111-15-C	15	230	GU10	Ø50- L.100	3000K
	• L.8111-15-F	15	230	GU10	Ø50- L.100	4000K

MICRO - LYNX GX53						
	• L.810-7-F	7	230	GX53	Ø75- L.24	4000K
	• L.810-11-C	11	230	GX53	Ø75- L.34	3000K
	• L.810-11-F	11	230	GX53	Ø75- L.34	4000K
	• L.810-13-F	13	230	GX53	Ø75- L.34	4000K

PLC ELETTRONICA						
	• L.929-9-C	9	230	E14	L.110 - L.40	3000K
	• L.929-9-F	9	230	E14	L.110 - L.40	4000K
	• L.929-11-C	11	230	E14	L.120 - L.40	3000K
	• L.929-11-F	11	230	E14	L.120 - L.40	4000K
	• L.932-15-F	15	230	E27	L.146 - L.45	4000K
	• L.932-20-F	20	230	E27	L.151 - L.45	4000K
	• L.932-23-C	23	230	E27	L.164 - L.48	3000K
	• L.932-23-F	23	230	E27	L.164 - L.48	4000K

LAMPADA FULL SPIRAL						
	• L.960-15-F	15	230	E27	L.118 - L.48	4000K
	• L.960-25-C	25	230	E27	L.150 - L.54	3000K
	• L.960-25-F	25	230	E27	L.150 - L.54	4000K



LAMPADINE FLUORESCENTI COMPATTE INTEGRATE COMPACT FLUORESCENT INTEGRATED BULBS

LAMPADA 4 TUBI	Codice Code	Watt	Volt	Attacco Lamp holder	Dimensioni Dimension	Descrizione Description
	● L.933-20	20	230	E27	L. 136 - L. 48	3000K
	● L.933-23	23	230	E27	L. 151 - L. 48	3000K

LAMPADA SLD ELETTRONICA						
	● L.908-15-C	15	230	E27	Ø80- L. 135	3000K
	● L.908-15-F	15	230	E27	Ø80- L. 135	4000K
	● L.908-20-C	20	230	E27	Ø95- L. 156	3000K
	● L.908-20-F	20	230	E27	Ø95- L. 156	4000K
	● L.908-25-C	25	230	E27	Ø95- L. 156	3000K
	● L.908-25-F	25	230	E27	Ø95- L. 156	4000K
	● L.908-30-C	30	230	E27	Ø120- L. 156	3000K
	● L.908-30-F	30	230	E27	Ø120- L. 156	4000K

FLUO GOCCIA						
	● L.961-9	9	230	E27	Ø60- L. 123	3000K
	● L.961-15	15	230	E27	Ø65- L. 133	3000K
	● L.961-20	20	230	E27	Ø70- L. 153	3000K

# LAMPADINE FLUORESCENTI FLUORESCENT BULBS

TUBI FLUORESCENTI LINEARI	Codice Code	Watt	Volt	Attacco Lamp holder	Dimensioni Dimension	Descrizione Description
	<b>SERIE FLUO T8</b>					
	L.501-18-82	18		G13	Ø26- L. 600	2700K
	L.501-18-83	18		G13	Ø26- L. 600	3000K
	L.501-18-84	18		G13	Ø26- L. 600	4000K
	L.501-18-86	18		G13	Ø26- L. 600	6500K
	L.501-36-82	36		G13	Ø26- L. 1200	2700K
	L.501-36-83	36		G13	Ø26- L. 1200	3000K
	L.501-36-86	36		G13	Ø26- L. 1200	6500K
	L.501-58-82	58		G13	Ø26- L. 1500	2700K
	L.501-58-83	58		G13	Ø26- L. 1500	3000K
L.501-58-84	58		G13	Ø26- L. 1500	4000K	
	<b>SERIE FLUO T5</b>					
	L.505-6	6		G5	Ø16 - L. 225	3000K
	L.505-8	8		G5	Ø16 - L. 288	3000K
	L.505-13	13		G5	Ø16 - L. 517	3000K
	L.505-14-83	14		G5	Ø16 - L. 549	3000K
	L.505-14-84	14		G5	Ø16 - L. 549	4000K
	L.505-21-83	21		G5	Ø16 - L. 849	3000K
	L.505-21-84	21		G5	Ø16 - L. 849	4000K
	L.505-24-83	24		G5	Ø16 - L. 549	3000K
	L.505-24-84	24		G5	Ø16 - L. 549	4000K
	L.505-28-83	28		G5	Ø16 - L. 1149	3000K
	L.505-28-84	28		G5	Ø16 - L. 1149	4000K
	L.505-35-83	35		G5	Ø16 - L. 1460	3000K
	L.505-35-84	35		G5	Ø16 - L. 1460	4000K
	L.505-39-83	39		G5	Ø16 - L. 849	3000K
	L.505-39-84	39		G5	Ø16 - L. 849	4000K
	L.505-54-83	54		G5	Ø16 - L. 1149	3000K
	L.505-54-84	54		G5	Ø16 - L. 1149	4000K
L.505-80-83	80		G5	Ø16 - L. 1449	3000K	
L.505-80-84	80		G5	Ø16 - L. 1449	4000K	
<b>TUBI FLUORESCENTI CIRCOLARI</b>						
	L.500-22	22		G10q	Ø200	4000K
	L.500-32	32		G10q	Ø300	4000K
	L.500-40	40		G10q	Ø400	4000K

4030

**PARALUMI PER LAMPADE DA TAVOLO IN LINO LAMPSHADES FOR TABLE LAMP IN LINEN**

codice code	dimensioni dimension	attacco connection
<b>4030-20</b>	Ø 200 mm - H. 130 mm	E14
<b>4030-25</b>	Ø 250 mm - H. 160 mm	E27
<b>4030-30</b>	Ø 300 mm - H. 170 mm	E27
<b>4030-35</b>	Ø 350 mm - H. 210 mm	E27
<b>4030-40</b>	Ø 400 mm - H. 240 mm	E27
<b>4030-45</b>	Ø 450 mm - H. 260 mm	E27
<b>4030-50</b>	Ø 500 mm - H. 280 mm	E27

4020

**PARALUMI PER LAMPADE DA TAVOLO IN TELETTA DI FORMA OVALE OVAL LAMPSHADES FOR TABLE LAMP IN FABRIC**

codice code	dimensioni dimension	attacco connection
<b>4020-20</b>	Ø 210 mm - H. 130 mm	E14
<b>4020-25</b>	Ø 250 mm - H. 160 mm	E27
<b>4020-30</b>	Ø 310 mm - H. 200 mm	E27
<b>4020-35</b>	Ø 350 mm - H. 210 mm	E27
<b>4020-40</b>	Ø 400 mm - H. 260 mm	E27
<b>4020-45</b>	Ø 450 mm - H. 300 mm	E27
<b>4020-50</b>	Ø 500 mm - H. 330 mm	E27

4050

**PARALUMI PER LAMPADE DA TAVOLO IN TELETTA LAMPSHADES FOR TABLE LAMP IN FABRIC**

codice code	dimensioni dimension	attacco connection
<b>4050-20</b>	Ø 200 mm - H. 130 mm	E14
<b>4050-25</b>	Ø 250 mm - H. 160 mm	E27
<b>4050-30</b>	Ø 300 mm - H. 180 mm	E27
<b>4050-35</b>	Ø 350 mm - H. 210 mm	E27
<b>4050-40</b>	Ø 400 mm - H. 240 mm	E27
<b>4050-45</b>	Ø 450 mm - H. 270 mm	E27
<b>4050-50</b>	Ø 500 mm - H. 280 mm	E27

4001

## PARALUMI PER LAMPADE DA TAVOLO E DA PARETE LAMPSHADES FOR TABLE AND WALL LAMPS



codice code	dimensioni dimension	attacco connection
<b>4001-11-AV</b>	L. 100 mm - H. 95 mm	molla - spring
<b>4001-13-AV</b>	L. 130 mm - H. 130 mm	molla - spring
<b>4001-16-AV</b>	L. 160 mm - H. 155 mm	E14
<b>4001-20-AV</b>	L. 200 mm - H. 190 mm	E14
<b>4001-27-AV</b>	L. 250 mm - H. 240 mm	E27

4015

## PARALUMI PER LAMPADE DI FORMA CONICA LAMPSHADES FOR CONICAL-SHAPE LAMPS



codice code	dimensioni dimension	attacco connection
<b>4015-25</b>	Ø 250 mm - H. 150 mm	E27
<b>4015-30</b>	Ø 300 mm - H. 170 mm	E27
<b>4015-35</b>	Ø 350 mm - H. 200 mm	E27
<b>4015-40</b>	Ø 400 mm - H. 230 mm	E27
<b>4015-45</b>	Ø 450 mm - H. 260 mm	E27

4007

## PARALUMI PER LAMPADE DA TAVOLO IN SHANTUNG LAMPSHADES FOR TABLE LAMPS IN SHANTUNG



codice code	dimensioni dimension	attacco connection
<b>4007-10-AV</b>	Ø 100 mm - H. 100 mm	molla - spring
<b>4007-14-AV</b>	Ø 140 mm - H. 120 mm	E14
<b>4007-17-AV</b>	Ø 160 mm - H. 140 mm	E14
<b>4007-20-AV</b>	Ø 200 mm - H. 190 mm	E14
<b>4007-23-AV</b>	Ø 230 mm - H. 210 mm	E14
<b>4007-28-AV</b>	Ø 280 mm - H. 280 mm	E27
<b>4007-32-AV</b>	Ø 320 mm - H. 290 mm	E27

4166

## PARALUMI PER LAMPADE DA TAVOLO IN SHANTUNG LAMPSHADES FOR TABLE LAMPS IN SHANTUNG



codice code	dimensioni dimension	attacco connection
<b>4166-20</b>	Ø 200 mm - H. 190 mm	E14
<b>4166-25</b>	Ø 250 mm - H. 210 mm	E27
<b>4166-30</b>	Ø 300 mm - H. 250 mm	E27
<b>4166-35</b>	Ø 350 mm - H. 300 mm	E27
<b>4166-45</b>	Ø 450 mm - H. 400 mm	E27

4197

## PARALUMI PER LAMPADE DA TAVOLO IN SHANTUNG LAMPSHADES FOR TABLE LAMPS IN SHANTUNG



codice code	dimensioni dimension	attacco connection
<b>4197-25</b>	Ø 250 mm - H. 190 mm	E27
<b>4197-30</b>	Ø 300 mm - H. 210 mm	E27
<b>4197-40</b>	Ø 400 mm - H. 280 mm	E27
<b>4197-50</b>	Ø 500 mm - H. 340 mm	E27

4018 - 4166

## PARALUMI PER LAMPADE DA TERRA IN SHANTUNG LAMPSHADES FOR FLOOR LAMPS IN SHANTUNG



4018-AV



4166-50

codice code	dimensioni dimension	attacco connection
<b>4018-AV</b>	Ø 500 mm - H. 480 mm	parabola
<b>4166-50</b>	Ø 500 mm - H. 480 mm	parabola

## V.608

GLOBO SENZA COLLO IN VETRO BIANCO LUCIDO O SATINATO GLOBE WITHOUT SUPPORT IN POLISHED OR SATIN WHITE GLASS



codice code	colore color	dimensioni dimension	attacco connection
V.608-12	BL SAT	Ø 115 mm	F.50
V.608-14	BL SAT	Ø 140 mm	F.50
V.608-16	BL SAT	Ø 160 mm	F.72
V.608-18	BL SAT	Ø 180 mm	F.72
V.608-20	BL SAT	Ø 200 mm	F.92
V.608-25	BL SAT	Ø 250 mm	F.104
V.608-30	BL SAT	Ø 300 mm	F.98
V.608-35	BL SAT	Ø 350 mm	F.152
V.608-40	BL SAT	Ø 400 mm	F.150

## V.509

GLOBO IN VETRO BIANCO LUCIDO CON COLLO GLOBE IN POLISHED WHITE GLASS WITH SUPPORT



codice code	dimensioni dimension	attacco connection
V.509-16	Ø 160 mm	G.78
V.509-20	Ø 200 mm	G.95
V.509-25	Ø 250 mm	G.95
V.509-30	Ø 300 mm	G.99
V.509-35	Ø 350 mm	G.150
V.509-40	Ø 400 mm	G.150

## V.915

**CAMPANA IN VETRO BIANCO LUCIDO CON BORDO BELL GLASS IN POLISHED WHITE GLASS WITH EDGE**

---



codice code	dimensioni dimension	attacco connection
V.915-100	Ø 115 mm - H. 100 mm	I.100
V.915-125	Ø 140 mm - H. 120 mm	I.120
V.915-180	Ø 200 mm - H. 140 mm	I.175
V.915-200	Ø 225 mm - H. 160 mm	I.195
V.915-230	Ø 280 mm - H. 205 mm	I.225
V.915-300	Ø 350 mm - H. 270 mm	I.300



VARIATORI DIMMER



**DM.502-N**  
 Varialuce da terra max 300W  
 Ground dimmer max 300W



**DM.509**  
 Varialuce da terra max 300W  
 Ground dimmer max 300W



**W.9502**  
 Varialuce da piede per moduli  
 led a tensione di rete  
 Foot dimmer for mains voltage  
 LEDs modules

colore color:  N  TR



L.40-L.15-H.45

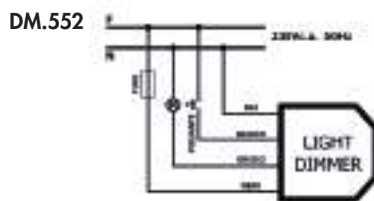

Variatore universale che permette di regolare tutte le lampade ad incandescenza, alogene, LED purché del tipo dimmerabile. Dispositivo azionabile tramite uno o più pulsanti NA, con collegamento indifferente su fase o su neutro.

Universal dimmers is possible to adjust all the incandescent lamps, halogen lamps, LED provided the type dimmable. The device can be operated by one or more pushbuttons NA, connected either on stage or on the neutral.

CARICATORE USB USB CHARGER

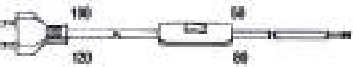

**MT.8USB**  
 Caricatore USB multiplo a 8 porte con luce LED, 40W - 18A, input:100-240V  
 8-port multiple USB charger with LED light, 40W - 18A, input: 100-240V

ACCESSORI ELETTRICI	codice code	descrizione description	colore color	Pz.
	<b>C.3053-B</b>	cablaggio CL2 100+50 wiring CL2 100+50	BIANCO/WHITE	250
	<b>C.3053-N</b>	cablaggio CL2 100+50 wiring CL2 100+50	NERO/BLACK	250
	<b>C.3053-OR</b>	cablaggio CL2 100+50 wiring CL2 100+50	ORO/GOLD	250
	<b>C.3054-B</b>	cablaggio CL2 120+80 wiring CL2 120+80	BIANCO/WHITE	250
	<b>C.3054-N</b>	cablaggio CL2 120+80 wiring CL2 120+80	NERO/BLACK	250
	<b>C.3054-OR</b>	cablaggio CL2 120+80 wiring CL2 120+80	ORO/GOLD	250
	<b>C.3052</b>	cablaggio conduttore IP40 CL2 100+50 conductor wiring IP40 CL2 100+50	TRASPARENTE/TRANSPARENT	
	<b>C.3056</b>	cablaggio conduttore IP40 CL2 120+80 conductor wiring IP40 CL2 120+80	TRASPARENTE/TRANSPARENT	

CONDUTTORI ELETTRICI (100mt)



**C.1-275**  
Piattina Flat 2 x 0,75

colore color:



**C.5-375-B-100**  
Treccia in tessuto Fabric braid 3 x 0,75  
100 mt - BIANCO/WHITE

**C.5-375-B-10**  
Treccia in tessuto Fabric braid 3 x 0,75  
10 mt - BIANCO/WHITE



**C.2-275**  
Cavo piatto doppio isolamento  
Flat cable with double insulation 2x0,75

colore color:



**C.82**  
Cavo trasparente tondo multipolare  
(2 x 0,75) isolato in FEP T 180° - PVC T  
105° doppio isolamento  
Round transparent cable multicore  
(2 x 0,75) FEP T 180° - PVC T  
105°insulated double insulation



**C.3-375**  
Cavo tondo doppio isolamento  
Round cable with double insulation 3x0,75

colore color:



**C.83**  
Cavo trasparente tondo multipolare  
(3 x 0,75) isolato in FEP T 180° - PVC T  
105° doppio isolamento  
Round transparent cable multicore  
(3 x 0,75) FEP T 180° - PVC T  
105°insulated double insulation



**C.3-475**  
Cavo tondo doppio isolamento  
Round cable with double insulation 4x0,75

colore color:



Spina bipolare/bipolar plug 10A/250V



**W.9518-B**  
200 pz. - BIANCO/WHITE

**W.9518-N**  
200 pz. - NERO/BLACK

INTERRUTTORI PASSANTI THROUGH SWITCHES	codice code	Descrizione Description	colore color
	<b>W.9500-B</b>	interruttore passante through switches	BIANCO/WHITE
	<b>W.9500-N</b>	interruttore passante through switches	NERO/BLACK
	<b>W.9500-TR</b>	interruttore passante through switches	TRASPARENTE/TRANSPARENT

 W.9503-70      W.9503-85	<b>W.9503-70</b>	E14 con nipples metallo (conf. 100 pz.) E14 with metal nipples (pack. 100 pz.)	
	<b>W.9503-85</b>	conf. 100 pz.    pack. 100 pz.	

**NIPPEL METALLO E14 E14 METAL NIPPEL**

	<b>W.9506-N</b>	conf. 100 pz.    pack. 100 pz.	NERO/BLACK
	<b>W.9506-B</b>	conf. 100 pz.    pack. 100 pz.	BIANCO/WHITE
	<b>W.9506-OR</b>	conf. 100 pz.    pack. 100 pz.	ORO/GOLD
	<b>W.9507-N</b>	conf. 100 pz.    pack. 100 pz.	NERO/BLACK
	<b>W.9507-B</b>	conf. 100 pz.    pack. 100 pz.	BIANCO/WHITE
	<b>W.9507-OR</b>	conf. 100 pz.    pack. 100 pz.	ORO/GOLD
	<b>W.9508-N</b>	conf. 100 pz.    pack. 100 pz.	NERO/BLACK
	<b>W.9508-B</b>	conf. 100 pz.    pack. 100 pz.	BIANCO/WHITE
	<b>W.9508-OR</b>	conf. 100 pz.    pack. 100 pz.	ORO/GOLD

**GHIERA IN MATERIALE PLASTICO PLASTIC RING**

	<b>W.D-9509-N</b>	conf. 100 pz.    pack. 100 pz.	NERO/BLACK
	<b>W.D-9509-B</b>	conf. 100 pz.    pack. 100 pz.	BIANCO/WHITE
	<b>W.D-9509-OR</b>	conf. 100 pz.    pack. 100 pz.	ORO/GOLD

<b>E27 LISCIO NIPPEL METALLO (...-T= con terra)</b>	codice code	Descrizione Description	colore color
	<b>W.9510-N</b>	conf. 50 pz. pack. 50 pz.	NERO/BLACK
	<b>W.9510-T-N</b>	conf. 50 pz. pack. 50 pz.	NERO/BLACK
	<b>W.9510-B</b>	conf. 50 pz. pack. 50 pz.	BIANCO/WHITE
	<b>W.9510-T-B</b>	conf. 50 pz. pack. 50 pz.	BIANCO/WHITE
	<b>W.9510-OR</b>	conf. 50 pz. pack. 50 pz.	ORO/GOLD
	<b>W.9510-T-OR</b>	conf. 50 pz. pack. 50 pz.	ORO/GOLD

<b>E27 FILETTATO NIPPEL METALLO (...-T= con terra)</b>			
	<b>W.9511-N</b>	conf. 50 pz. pack. 50 pz.	NERO/BLACK
	<b>W.9511-T-N</b>	conf. 50 pz. pack. 50 pz.	NERO/BLACK
	<b>W.9511-B</b>	conf. 50 pz. pack. 50 pz.	BIANCO/WHITE
	<b>W.9511-T-B</b>	conf. 50 pz. pack. 50 pz.	BIANCO/WHITE
	<b>W.9511-OR</b>	conf. 50 pz. pack. 50 pz.	ORO/GOLD
	<b>W.9511-T-OR</b>	conf. 50 pz. pack. 50 pz.	ORO/GOLD

<b>E27 FILETTATO CON BATTUTA NIPPEL METALLO (...-T= con terra)</b>			
	<b>W.9512-N</b>	conf. 50 pz. pack. 50 pz.	NERO/BLACK
	<b>W.9512-T-N</b>	conf. 50 pz. pack. 50 pz.	NERO/BLACK
	<b>W.9512-B</b>	conf. 50 pz. pack. 50 pz.	BIANCO/WHITE
	<b>W.9512-T-B</b>	conf. 50 pz. pack. 50 pz.	BIANCO/WHITE
	<b>W.9512-OR</b>	conf. 50 pz. pack. 50 pz.	ORO/GOLD
	<b>W.9512-T-OR</b>	conf. 50 pz. pack. 50 pz.	ORO/GOLD

<b>CANDELA PER: 9503-70/85</b>			
	<b>W.C-9504-A</b>	conf. 100 pz. pack. 100 pz.	AMBRA/AMBER
	<b>W.C-9504-B</b>	conf. 100 pz. pack. 100 pz.	BIANCO/WHITE
	<b>W.C-9505-A</b>	conf. 100 pz. pack. 100 pz.	AMBRA/AMBER
	<b>W.C-9505-B</b>	conf. 100 pz. pack. 100 pz.	BIANCO/WHITE

GHIERA PER E27	codice code	Descrizione Description	colore color
	<b>W.D-28-N</b>	conf. 50 pz. pack. 50 pz.	NERO/BLACK
	<b>W.D-28-B</b>	conf. 50 pz. pack. 50 pz.	BIANCO/WHITE
	<b>W.D-28-OR</b>	conf. 50 pz. pack. 50 pz.	ORO/GOLD

ROSONE			
	<b>W.9517-B</b>	Rosone in materiale plastico Plastic rosette H.75 - Ø 110	BIANCO/WHITE
	<b>W.9517-N</b>	Rosone in materiale plastico Plastic rosette H.75 - Ø 110	NERO/BLACK

KIT SOSPENSIONE			
	<b>MT.385-B</b>	Kit sospensione Suspension Kit	BIANCO/WHITE
	<b>MT.385-N</b>	Kit sospensione Suspension Kit	NERO/BLACK
Sospensione pendel completa Classe II E27 - Ø 70 - H.800 Complete pendel Class II E27 - Ø 70 - H.800			





INDICE  
INDEX

INDICE INDEX

10106-20-ARG	<b>571</b>	10521-45	<b>511</b>	10632-30-OL-LED	<b>539</b>	1404-B	<b>339</b>	1669-35-CR	<b>487</b>
10106-25-ARG	<b>571</b>	10521-45-LED	<b>511</b>	10632-40-B	<b>539</b>	1626-30	<b>535</b>	1669-35-GR	<b>487</b>
10106-35-ARG	<b>571</b>	10521-55	<b>511</b>	10632-40-B-LED	<b>539</b>	1626-40	<b>535</b>	1669-35-N	<b>487</b>
10118-20	<b>502</b>	10521-55-LED	<b>511</b>	10632-40-CR	<b>539</b>	1626-50	<b>535</b>	1669-35-OL	<b>487</b>
10118-20-LED	<b>502</b>	1052-30-CRI	<b>549</b>	10632-40-CR-LED	<b>539</b>	1639-25	<b>548</b>	1678-30	<b>543</b>
10118-30	<b>502</b>	1052-40-CRI	<b>549</b>	10632-40-OL	<b>539</b>	1639-35	<b>548</b>	1678-40	<b>543</b>
10118-30-LED	<b>502</b>	1052-50-CRI	<b>549</b>	10632-40-OL-LED	<b>539</b>	1645-30-ARG	<b>531</b>	1682-CRI	<b>585</b>
10301-20	<b>439</b>	10630-20-B	<b>538</b>	10720-100-B	<b>423</b>	1645-30-NO	<b>531</b>	1682-N	<b>585</b>
10302-100	<b>439</b>	10630-20-B-LED	<b>538</b>	10720-60-B	<b>423</b>	1645-30-ORO	<b>531</b>	1710-3-B	<b>486</b>
10322-5	<b>639</b>	10630-20-CR	<b>538</b>	10721-100-B	<b>423</b>	1645-40-ARG	<b>531</b>	1710-3-N	<b>486</b>
10323-3	<b>639</b>	10630-20-CR-LED	<b>538</b>	10721-60-B	<b>423</b>	1645-40-NO	<b>531</b>	1710-B	<b>486</b>
10323-5	<b>639</b>	10630-20-OL	<b>538</b>	1072-30-B	<b>581</b>	1645-40-ORO	<b>531</b>	1710-N	<b>486</b>
1032-B	<b>599</b>	10630-20-OL-LED	<b>538</b>	1072-40-B	<b>581</b>	1645-50-ARG	<b>531</b>	2021-5	<b>616</b>
1032-N	<b>599</b>	10630-30-B	<b>538</b>	1072-50-B	<b>581</b>	1645-50-NO	<b>531</b>	2021-8	<b>616</b>
1032-R	<b>599</b>	10630-30-B-LED	<b>538</b>	1073-40-B	<b>581</b>	1645-50-ORO	<b>531</b>	2037-30	<b>667</b>
10330-25	<b>325</b>	10630-30-CR	<b>538</b>	1073-60-B	<b>581</b>	1650-30-ARG	<b>522</b>	2037-40	<b>667</b>
10330-50	<b>325</b>	10630-30-CR-LED	<b>538</b>	10770-60-AV	<b>415</b>	1650-30-ORO	<b>522</b>	2037-50	<b>667</b>
1036	<b>627</b>	10630-30-OL	<b>538</b>	10770-60-AV-LED	<b>415</b>	1650-40-ARG	<b>522</b>	2037-60	<b>667</b>
1036-70	<b>627</b>	10630-30-OL-LED	<b>538</b>	10770-60-GR	<b>415</b>	1650-40-ORO	<b>522</b>	2040-5	<b>633</b>
10455-35	<b>321</b>	10630-40-B	<b>538</b>	10770-60-GR-LED	<b>415</b>	1654-30-B	<b>550</b>	2040-6	<b>633</b>
10455-50	<b>321</b>	10630-40-B-LED	<b>538</b>	10771-50-AV	<b>414</b>	1654-30-CR	<b>550</b>	2041-5	<b>624</b>
10501-35	<b>533</b>	10630-40-CR	<b>538</b>	10771-50-GR	<b>414</b>	1654-30-OL	<b>550</b>	2041-6	<b>624</b>
10501-35-LED	<b>533</b>	10630-40-CR-LED	<b>538</b>	10771-60-AV	<b>414</b>	1654-40-B	<b>550</b>	2064	<b>630</b>
10501-45	<b>533</b>	10630-40-OL	<b>538</b>	10771-60-AV-LED	<b>414</b>	1654-40-CR	<b>550</b>	2064-3	<b>630</b>
10501-45-LED	<b>533</b>	10630-40-OL-LED	<b>538</b>	10771-60-GR	<b>414</b>	1654-40-OL	<b>550</b>	2064-8	<b>630</b>
1050-35-AM	<b>547</b>	10632-20-B	<b>539</b>	10771-60-GR-LED	<b>414</b>	1669-15-B	<b>487</b>	2074-5-AV	<b>607</b>
1050-35-BLU	<b>547</b>	10632-20-B-LED	<b>539</b>	10771-AV	<b>414</b>	1669-15-CR	<b>487</b>	2074-6+3-AV	<b>607</b>
1050-35-CRI	<b>547</b>	10632-20-CR	<b>539</b>	10771-GR	<b>414</b>	1669-15-GR	<b>487</b>	2166	<b>411</b>
1050-45-AM	<b>547</b>	10632-20-CR-LED	<b>539</b>	10801-40	<b>288</b>	1669-15-N	<b>487</b>	2168	<b>411</b>
1050-45-BLU	<b>547</b>	10632-20-OL	<b>539</b>	10801-50	<b>288</b>	1669-15-OL	<b>487</b>	2596-20	<b>363</b>
1050-45-CRI	<b>547</b>	10632-20-OL-LED	<b>539</b>	10850-20	<b>351</b>	1669-25-B	<b>487</b>	2596-40	<b>363</b>
10520-30	<b>669</b>	10632-30-B	<b>539</b>	1400-70	<b>367</b>	1669-25-CR	<b>487</b>	2597-12	<b>388</b>
10520-40	<b>669</b>	10632-30-B-LED	<b>539</b>	1400-90	<b>367</b>	1669-25-GR	<b>487</b>	2597-3	<b>388</b>
10520-50	<b>669</b>	10632-30-CR	<b>539</b>	1401-70	<b>367</b>	1669-25-N	<b>487</b>	2597-6	<b>388</b>
10521-30	<b>511</b>	10632-30-CR-LED	<b>539</b>	1404-45-B	<b>339</b>	1669-25-OL	<b>487</b>	2598-3	<b>389</b>
10521-30-LED	<b>511</b>	10632-30-OL	<b>539</b>			1669-35-B	<b>487</b>	2598-6	<b>389</b>



# INDICE INDEX

2632-30-AR	<b>498</b>	3460-9-CR	<b>385</b>	3868-45	<b>346</b>	4030-50	<b>740</b>	5205-RA	<b>409</b>
2632-30-AR-LED	<b>498</b>	3460-9-OS	<b>385</b>	3909-30-B	<b>673</b>	4050-20	<b>740</b>	5422-19	<b>391</b>
2632-30-B	<b>498</b>	3461-55-CR	<b>385</b>	3909-30-MS	<b>673</b>	4050-25	<b>740</b>	5465-25	<b>542</b>
2632-30-B-LED	<b>498</b>	3461-55-OS	<b>385</b>	3909-40-B	<b>673</b>	4050-30	<b>740</b>	5465-35	<b>542</b>
2632-30-N	<b>498</b>	3476	<b>619</b>	3909-40-MS	<b>673</b>	4050-35	<b>740</b>	5465-45	<b>542</b>
2632-30-N-LED	<b>498</b>	3477-1	<b>619</b>	4001-11-AV	<b>741</b>	4050-40	<b>740</b>	5487-16-B	<b>315</b>
2632-40-AR	<b>498</b>	3485-40-G	<b>587</b>	4001-13-AV	<b>741</b>	4050-45	<b>740</b>	5487-20-B	<b>315</b>
2632-40-AR-LED	<b>498</b>	3485-40-SAT	<b>587</b>	4001-16-AV	<b>741</b>	4050-50	<b>740</b>	5487-30-B	<b>315</b>
2632-40-B	<b>498</b>	3485-40-V	<b>587</b>	4001-20-AV	<b>741</b>	4166-20-AV	<b>742</b>	5487-40-B	<b>315</b>
2632-40-B-LED	<b>498</b>	3485-55-G	<b>587</b>	4001-27-AV	<b>741</b>	4166-25-AV	<b>742</b>	5488-16-B	<b>313</b>
2632-40-N	<b>498</b>	3485-55-SAT	<b>587</b>	4007-10-AV	<b>741</b>	4166-30-AV	<b>742</b>	5488-20-B	<b>313</b>
2632-40-N-LED	<b>498</b>	3485-55-V	<b>587</b>	4007-14-AV	<b>741</b>	4166-35-AV	<b>742</b>	5488-30-B	<b>313</b>
2632-55-AR	<b>498</b>	3598-20	<b>373</b>	4007-17-AV	<b>741</b>	4166-45-AV	<b>742</b>	5488-40-B	<b>313</b>
2632-55-AR-LED	<b>498</b>	3598-40	<b>373</b>	4007-20-AV	<b>741</b>	4166-50	<b>742</b>	5488-40-B-LED	<b>313</b>
2632-55-B	<b>498</b>	3618-25	<b>528</b>	4007-23-AV	<b>741</b>	4197-25	<b>742</b>	7560-B	<b>719</b>
2632-55-B-LED	<b>498</b>	3618-25-LED	<b>528</b>	4007-28-AV	<b>741</b>	4197-30	<b>742</b>	7560-CR	<b>719</b>
2632-55-N	<b>498</b>	3618-35	<b>528</b>	4007-32-AV	<b>741</b>	4197-40	<b>742</b>	7561-B	<b>719</b>
2632-55-N-LED	<b>498</b>	3618-35-LED	<b>528</b>	4015-25	<b>741</b>	4197-50	<b>742</b>	7561-CR	<b>719</b>
3183-1-B	<b>441</b>	3618-35-LED-S	<b>528</b>	4015-30	<b>741</b>	5001	<b>645</b>	7562-B	<b>719</b>
3183-1-CR	<b>441</b>	3618-45	<b>528</b>	4015-35	<b>741</b>	5002	<b>645</b>	7562-CR	<b>719</b>
3183-1-GR	<b>441</b>	3618-45-LED	<b>528</b>	4015-40	<b>741</b>	5003	<b>645</b>	7567-B	<b>721</b>
3183-1-N	<b>441</b>	3618-45-LED-S	<b>528</b>	4015-45	<b>741</b>	5004	<b>645</b>	7567-BZ	<b>721</b>
3183-1-OS	<b>441</b>	3618-55	<b>529</b>	4018-AV	<b>742</b>	5015-60	<b>711</b>	7570	<b>721</b>
3218	<b>265</b>	3618-55-LED	<b>529</b>	4020-20	<b>740</b>	5026-60	<b>713</b>	794-30	<b>410</b>
3230-50	<b>544</b>	3619-30	<b>505</b>	4020-25	<b>740</b>	5026-60-LED	<b>713</b>	794-40	<b>410</b>
3230-60	<b>544</b>	3619-30-LED	<b>505</b>	4020-30	<b>740</b>	5026-80	<b>713</b>	8801	<b>514</b>
3350	<b>444</b>	3619-40	<b>505</b>	4020-35	<b>740</b>	5026-80-LED	<b>713</b>	8802-45	<b>515</b>
3350-1	<b>444</b>	3619-40-LED	<b>505</b>	4020-40	<b>740</b>	5028	<b>713</b>	8802-45-LED	<b>515</b>
3400-10	<b>503</b>	3619-40-LED-S	<b>505</b>	4020-45	<b>740</b>	5028-LED	<b>713</b>	8802-60	<b>515</b>
3400-15	<b>503</b>	3619-50	<b>505</b>	4020-50	<b>740</b>	5041-60-LED	<b>710</b>	8802-60-LED	<b>515</b>
3400-15-LED	<b>503</b>	3619-50-LED	<b>505</b>	4030-20	<b>740</b>	5042-LED	<b>710</b>	8816	<b>521</b>
3424-B	<b>574</b>	3788-5-OL	<b>661</b>	4030-25	<b>740</b>	5043	<b>711</b>	8817	<b>517</b>
3445	<b>671</b>	3865	<b>359</b>	4030-30	<b>740</b>	5205-B	<b>409</b>	931-30	<b>672</b>
3448	<b>671</b>	3867-30-LED	<b>346</b>	4030-35	<b>740</b>	5205-GR	<b>409</b>	931-40	<b>672</b>
3460-6-CR	<b>385</b>	3867-45-LED	<b>346</b>	4030-40	<b>740</b>	5205-N	<b>409</b>	931-50	<b>672</b>
3460-6-OS	<b>385</b>	3868-30	<b>346</b>	4030-45	<b>740</b>	5205-OS	<b>409</b>	9401	<b>650</b>

INDICE INDEX

9402	<b>650</b>	A.10521-40	<b>511</b>	A.2040-2	<b>633</b>	A.3182-OS	<b>441</b>	A.3867-20-LED	<b>347</b>
9403	<b>650</b>	A.10521-40-LED	<b>511</b>	A.2041-2	<b>624</b>	A.3290	<b>554</b>	A.3867-30	<b>347</b>
9404	<b>650</b>	A.10521-50	<b>511</b>	A.2064-2	<b>630</b>	A.3293	<b>551</b>	A.3867-30-LED	<b>347</b>
9405	<b>651</b>	A.10521-50-LED	<b>511</b>	A.2074-1-AV	<b>607</b>	A.3294	<b>551</b>	A.3909-B	<b>673</b>
9406	<b>651</b>	A.10521-70	<b>511</b>	A.2596-40	<b>363</b>	A.3295-26	<b>553</b>	A.3909-MS	<b>673</b>
9530-B	<b>644</b>	A.10521-70-LED	<b>511</b>	A.2598-1	<b>389</b>	A.3295-37	<b>553</b>	A.4260	<b>708</b>
9531-B	<b>644</b>	A.10521-80	<b>511</b>	A.2598-3	<b>389</b>	A.3296-26	<b>553</b>	A.4262	<b>708</b>
A.10106-ARG	<b>571</b>	A.10521-80-LED	<b>511</b>	A.2632-30-AR	<b>498</b>	A.3296-37	<b>553</b>	A.4356-30	<b>437</b>
A.10301-20	<b>439</b>	A.1052-30-CRI	<b>549</b>	A.2632-30-B	<b>498</b>	A.3297-26	<b>553</b>	A.4362	<b>435</b>
A.1032-1-B	<b>599</b>	A.1052-40-CRI	<b>549</b>	A.2632-30-N	<b>498</b>	A.3297-37	<b>553</b>	A.4363	<b>433</b>
A.1032-1-N	<b>599</b>	A.10582	<b>706</b>	A.2632-65-AR	<b>498</b>	A.3298-26	<b>553</b>	A.4369-ARG	<b>473</b>
A.1032-1-R	<b>599</b>	A.10583	<b>706</b>	A.2632-65-ARLED	<b>498</b>	A.3298-37	<b>553</b>	A.4369-B	<b>473</b>
A.10322-2	<b>639</b>	A.1072-30-B	<b>581</b>	A.2632-65-B	<b>498</b>	A.3342-15	<b>561</b>	A.4369-OL	<b>473</b>
A.10330-20	<b>325</b>	A.1072-40-B	<b>581</b>	A.2632-65-B-LED	<b>498</b>	A.3342-30	<b>561</b>	A.4370-ARG	<b>473</b>
A.10349-15-B	<b>450</b>	A.1075-B	<b>359</b>	A.2632-65-N	<b>498</b>	A.3350-1	<b>444</b>	A.4370-B	<b>473</b>
A.10349-15-GR	<b>450</b>	A.10770-AV	<b>415</b>	A.2632-65-N-LED	<b>498</b>	A.3350-185	<b>445</b>	A.4370-OL	<b>473</b>
A.10349-30-B	<b>450</b>	A.10770-AV-LED	<b>415</b>	A.3026-CR	<b>709</b>	A.3400	<b>502</b>	A.4371-ARG	<b>473</b>
A.10349-30-GR	<b>450</b>	A.10770-GR	<b>415</b>	A.3026-GR	<b>709</b>	A.3424-15-B	<b>575</b>	A.4371-B	<b>473</b>
A.10349-50-B	<b>450</b>	A.10770-GR-LED	<b>415</b>	A.3028-B	<b>704</b>	A.3424-30-B	<b>575</b>	A.4371-OL	<b>473</b>
A.10349-50-GR	<b>450</b>	A.10850-20	<b>351</b>	A.3028-CR	<b>704</b>	A.3425-B	<b>575</b>	A.4700	<b>519</b>
A.10354-B	<b>455</b>	A.10850-30	<b>351</b>	A.3028-OL	<b>704</b>	A.3460-3-CR	<b>385</b>	A.4701	<b>519</b>
A.10355-B	<b>455</b>	A.1173-25-B	<b>453</b>	A.3029-B	<b>704</b>	A.3460-3-OS	<b>385</b>	A.4702	<b>519</b>
A.10357-10-B	<b>694</b>	A.1173-25-CR	<b>453</b>	A.3029-CR	<b>704</b>	A.3476	<b>619</b>	A.4719-BZ	<b>705</b>
A.10357-5-B	<b>694</b>	A.1173-25-N	<b>453</b>	A.3029-OL	<b>704</b>	A.3598	<b>373</b>	A.4719-CR	<b>705</b>
A.1036-1	<b>627</b>	A.1400	<b>367</b>	A.3030-B	<b>704</b>	A.3618	<b>529</b>	A.4719-OL	<b>705</b>
A.10470-30	<b>343</b>	A.1404-30-SX-B	<b>339</b>	A.3030-CR	<b>704</b>	A.3625-20-B	<b>557</b>	A.5153	<b>437</b>
A.10470-30-LED	<b>343</b>	A.1654-B	<b>550</b>	A.3030-OL	<b>704</b>	A.3625-20-B-LED	<b>557</b>	A.5154	<b>437</b>
A.10470-40	<b>343</b>	A.1654-CR	<b>550</b>	A.3031-B	<b>704</b>	A.3625-35-B	<b>557</b>	A.5157	<b>437</b>
A.10470-40-LED	<b>343</b>	A.1654-OL	<b>550</b>	A.3031-CR	<b>704</b>	A.3625-35-B-LED	<b>557</b>	A.5422-12	<b>391</b>
A.1050-30-AM	<b>547</b>	A.1664-ARG	<b>465</b>	A.3031-OL	<b>704</b>	A.3625-60-B	<b>557</b>	A.6306-AM	<b>559</b>
A.1050-30-BLU	<b>547</b>	A.1664-ORO	<b>465</b>	A.3061-1	<b>663</b>	A.3625-60-B-LED	<b>557</b>	A.6306-B	<b>559</b>
A.1050-30-CRI	<b>547</b>	A.1678	<b>543</b>	A.3061-2	<b>663</b>	A.3788-OL	<b>661</b>	A.6307-AM	<b>559</b>
A.1050-40-AM	<b>547</b>	A.1710-B	<b>486</b>	A.3182-B	<b>441</b>	A.3865	<b>359</b>	A.6307-B	<b>559</b>
A.1050-40-BLU	<b>547</b>	A.1710-N	<b>486</b>	A.3182-CR	<b>441</b>	A.3867-10	<b>347</b>	A.6308-AM	<b>559</b>
A.1050-40-CRI	<b>547</b>	A.2004-CR	<b>619</b>	A.3182-GR	<b>441</b>	A.3867-10-LED	<b>347</b>	A.6308-B	<b>559</b>
A.10520	<b>669</b>	A.2021-2	<b>616</b>	A.3182-N	<b>441</b>	A.3867-20	<b>347</b>	A.6523	<b>454</b>

# INDICE INDEX

A.6524	<b>454</b>	AIS001B	<b>401</b>	AUD001B	<b>293</b>	BAA001T	<b>207</b>	BOL005	<b>613</b>
A.6526	<b>454</b>	AIS001BZ	<b>401</b>	AUD001N	<b>293</b>	BAA003B	<b>207</b>	BS.10610-3	<b>379</b>
A.6554-14	<b>454</b>	AIS002B	<b>401</b>	AUS001ARG	<b>471</b>	BAA003N	<b>207</b>	BS.10610-4	<b>379</b>
A.6554-21	<b>454</b>	AIS002BZ	<b>401</b>	AUS001B	<b>471</b>	BAA003T	<b>207</b>	BUB001B	<b>182</b>
A.6554-8	<b>454</b>	AIS003B	<b>401</b>	AUS001OL	<b>471</b>	BAL001	<b>579</b>	BUB001N	<b>182</b>
A.7225-E27	<b>433</b>	AIS003BZ	<b>401</b>	AUS002ARG	<b>471</b>	BAL002	<b>579</b>	BUB001T	<b>182</b>
A.7226-30R	<b>435</b>	ALB001	<b>555</b>	AUS002B	<b>471</b>	BAL003	<b>579</b>	BUB002B	<b>182</b>
A.7227-10	<b>429</b>	AMA001	<b>603</b>	AUS002OL	<b>471</b>	BAL005	<b>579</b>	BUB002N	<b>182</b>
A.7227-15	<b>429</b>	AMA002	<b>603</b>	AUS003ARG	<b>471</b>	BAR001	<b>485</b>	BUB002T	<b>182</b>
A.7233	<b>435</b>	AMA004	<b>604</b>	AUS003B	<b>471</b>	BAR002	<b>485</b>	BUB003B	<b>182</b>
A.7235	<b>437</b>	AMA006	<b>605</b>	AUS003OL	<b>471</b>	BAR003	<b>485</b>	BUB003N	<b>182</b>
A.7237-35	<b>433</b>	AMA008	<b>604</b>	AUS004ARG	<b>471</b>	BAR004	<b>485</b>	BUB003T	<b>182</b>
A.7237-50	<b>433</b>	ANN001	<b>664</b>	AUS004B	<b>471</b>	BAZ001B	<b>509</b>	BUB004B	<b>182</b>
A.8801	<b>515</b>	ARB101BLU	<b>212</b>	AUS004OL	<b>471</b>	BAZ001N	<b>509</b>	BUB004N	<b>182</b>
A.8801-LED	<b>515</b>	ARB101CRI	<b>212</b>	AUS005ARG	<b>471</b>	BEL001N	<b>269</b>	BUB004T	<b>182</b>
A.8802-70-LED	<b>515</b>	ARB101FU	<b>212</b>	AUS005B	<b>471</b>	BEL001VS	<b>269</b>	BUB005B	<b>182</b>
A.8805-B	<b>447</b>	ARG001B	<b>145</b>	AUS005OL	<b>471</b>	BEL002N	<b>269</b>	BUB005N	<b>182</b>
A.8805-B-LED	<b>447</b>	ARG001BOS	<b>145</b>	AUS006ARG	<b>471</b>	BEL002VS	<b>269</b>	BUB005T	<b>182</b>
A.8815	<b>521</b>	ARG001GR	<b>145</b>	AUS006B	<b>471</b>	BEN001B	<b>209</b>	BYR001AV	<b>418</b>
A.8816-16	<b>521</b>	ARG001N	<b>145</b>	AUS006OL	<b>471</b>	BEN001CR	<b>209</b>	BYR001GR	<b>418</b>
A.8816-28	<b>521</b>	ARG001NOS	<b>145</b>	AXI001B	<b>128</b>	BEN001N	<b>209</b>	BYR002AV	<b>418</b>
A.8817-12	<b>517</b>	ARG002B	<b>145</b>	AXI001N	<b>128</b>	BEO001CR	<b>483</b>	BYR002GR	<b>418</b>
A.8817-23	<b>517</b>	ARG002BOS	<b>145</b>	AXI002B	<b>128</b>	BEO001N	<b>483</b>	BYR003AV	<b>418</b>
A.8817-45	<b>517</b>	ARG002GR	<b>145</b>	AXI002N	<b>128</b>	BEO002CR	<b>483</b>	BYR003GR	<b>418</b>
A.8819-14-B	<b>447</b>	ARG002N	<b>145</b>	AXI005B	<b>124</b>	BEO002N	<b>483</b>	BYR004AV	<b>418</b>
A.8819-23-B	<b>447</b>	ARG002NOS	<b>145</b>	AXI005BZ	<b>124</b>	BEO003CR	<b>483</b>	BYR004GR	<b>418</b>
A.8819-64-B	<b>447</b>	ARG003	<b>149</b>	AXI005N	<b>124</b>	BEO003N	<b>483</b>	BYR005AV	<b>419</b>
A.9407	<b>651</b>	ARG004	<b>149</b>	AXI006B	<b>128</b>	BEO004CR	<b>483</b>	BYR005GR	<b>419</b>
A.9408	<b>651</b>	ASI001B	<b>139</b>	AXI006N	<b>128</b>	BEO004N	<b>483</b>	BYR006AV	<b>419</b>
A.9409	<b>651</b>	ASI001BOS	<b>139</b>	AXI007B	<b>128</b>	BES001	<b>309</b>	BYR006GR	<b>419</b>
A.9521-B	<b>644</b>	ASI001N	<b>139</b>	AXI007N	<b>128</b>	BES002	<b>309</b>	BYR007AV	<b>419</b>
A.9521-BLU	<b>644</b>	ASI001NB	<b>139</b>	AXI008B	<b>125</b>	BES003	<b>309</b>	BYR007GR	<b>419</b>
A.9521-MA	<b>644</b>	ASI002B	<b>140</b>	AXI008BZ	<b>125</b>	BES004	<b>309</b>	C.1-275-AR-100	<b>746</b>
A.9522-B	<b>644</b>	ASI002BOS	<b>140</b>	AXI008N	<b>125</b>	BOL001	<b>612</b>	C.1-275-B-100	<b>746</b>
A.9522-BLU	<b>644</b>	ASI002N	<b>140</b>	BAA001B	<b>207</b>	BOL002	<b>612</b>	C.1-275-BC-100	<b>746</b>
A.9522-MA	<b>644</b>	ASI002NB	<b>140</b>	BAA001N	<b>207</b>	BOL004	<b>613</b>	C.1-275-MA-100	<b>746</b>

INDICE INDEX

C.1-275-N-100	746	CHO004B	133	D.9503-35	652	DRA010NCA	162	ERK103B	107
C.1-275-OR-100	746	CHO004N	133	D.9504-18	652	DRIO01B	475	ERK103BZ	107
C.2-275-B-100	746	CHO005B	132	D.9504-32	652	DRIO01GR	475	ERK103CR	107
C.2-275-N-100	746	CHO006B	132	D.9504-40	652	DRIO01N	475	ERK103N	107
C.2-275-OR-100	746	CHO007B	132	D.9550-20-B	645	DRIO02B	477	ERK103RA	107
C.3052	745	CHO008B	133	D.9550-20-BLU	645	DRIO02GR	477	ERK105B	107
C.3053-B	746	CHO008N	133	D.9550-20-MA	645	DRIO02N	477	ERK105BZ	107
C.3053-N	746	CIL002	656	D.9550-40-B	645	DYLO01	707	ERK105CR	107
C.3053-OR	746	CIL003	656	D.9550-40-BLU	645	DYLO02	707	ERK105N	107
C.3054-B	746	CIL005	656	D.9550-40-MA	645	DYLO03	707	ERK105RA	107
C.3054-N	746	CIL006	656	DAS001B	195	EDIO01B	459	F.TAE	692
C.3054-OR	746	CIL007	657	DAS001BZ	195	EDIO01N	459	FEL001B	641
C.3056	746	CIL008	657	DAS001N	195	EDIO02B	459	FEL001N	641
C.3-375-B-100	746	CIL009	657	DAS001NS	195	EDIO02N	459	FEL002B	641
C.3-375-N-100	746	CLA001	332	DM.502-N	745	EDIO03B	459	FEL002N	641
C.3-375-OR-100	746	COL001	369	DM.509	745	EDIO03N	459	FEL003B	641
C.3-475-B-100	746	COL003	369	DM.552	745	EDIO04B	459	FEL003N	641
C.3-475-GR-100	746	COL005	369	DRA001B	162	EDIO04N	459	FEL004B	641
C.3-475-N-100	746	COR001B	297	DRA001BCA	162	EMI001	313	FEL004N	641
C.3-475-OR-100	746	COR001N	297	DRA001N	162	EMI002	313	FEN002	659
C.5-375-10-B	645	COR002B	297	DRA001NCA	162	EMI003	317	FEN004	659
C.5-375-B-100	645	COR002N	297	DRA003B	162	EMI004	315	FEN005	659
C.82-100	746	COR003B	297	DRA003BCA	162	EMI005	315	FEN007	659
C.83-100	746	COR003N	297	DRA003N	162	EMI006	315	FLY001N	303
CAA001	249	CRY001B	56	DRA003NCA	162	EMP001B	91	FLY001OS	303
CAA002	249	CRY001OS	56	DRA005B	163	EMP001G	91	FLY002N	303
CAR001	263	CRY002B	56	DRA005BCA	163	EMP001N	91	FLY002OS	303
CAR002	263	CRY002OS	56	DRA005N	163	ENS001B	201	FLY003N	303
CAR003	263	CRY003B	56	DRA005NCA	163	ENS001N	201	FLY003OS	303
CHN001B	563	CRY003OS	56	DRA009B	163	ERIO01B	285	FLY004N	303
CHN001N	563	CRY004B	56	DRA009BCA	163	ERIO01N	285	FLY004OS	303
CHO001B	133	CRY004OS	56	DRA009N	163	ERK101B	105	FLY005N	305
CHO001N	133	CUR001OTN	253	DRA009NCA	163	ERK101BZ	105	FLY005OS	305
CHO002B	133	CUR001R	253	DRA010B	162	ERK101CR	105	FLY006N	305
CHO002N	133	D.9503-20	652	DRA010BCA	162	ERK101N	105	FLY006OS	305
CHO003B	132	D.9503-29	652	DRA010N	162	ERK101RA	105	FLY007N	305

# INDICE INDEX

FLY007OS	305	GII003TR	232	KAH101B	174	KITDEC003B	225	L.205-35-6	735
FOL001B	507	GII003V	232	KAH101MT	174	KITDEC003CR	225	L.212-35	735
FOL001N	507	GOG001NB	541	KAH101N	174	KITDEC005B	225	L.212-50	735
FOL002B	507	GOG002NB	541	KAH101OS	174	KITDEC005CR	225	L.213-100	735
FOL002N	507	GOG003NB	541	KAH102B	174	KITDEC101B	140	L.222-40	735
FRI001B	116	GOG004NB	541	KAH102MT	176	KITDEC101N	140	L.223-50	735
FRI001G	116	GRE001B	716	KAH102N	174	KITDEC103B	140	L.24-18	736
FRI001N	116	GRE001GR	716	KAH102OS	174	KITDEC103N	140	L.24-28	736
FRI001OS	116	IGL001B	47	KAH103B	175	KITDEC105B	140	L.24-42	736
FRI001R	116	IGL001NOL	47	KAH103MT	176	KITDEC105N	140	L.25-18	736
FRI002B	117	IGL002B	47	KAH103N	175	KITDEC201B	140	L.25-28	736
FRI002N	117	IGL002NOL	47	KAH103OS	175	KITDEC201N	140	L.25-42	736
FRI002OS	117	IGL003B	47	KAH104B	175	KITPAR002B	605	L.255-3-C	732
FRI003B	116	IGL003NOL	47	KAH104MT	177	KITPAR003B	603	L.257-5-C	732
FRI003G	116	IGL004B	47	KAH104N	175	KITPAR005B	603	L.257-C-30	732
FRI003N	116	IGL004NOL	47	KAH104OS	175	KITPAR008B	604	L.257-C-8	732
FRI003R	116	IKU001B	157	KAH105MT	177	KITPAR012B	604	L.257-F-30	732
FRI004B	117	IKU001BDA	157	KAL001AR	568	KOF001	375	L.257-F-8	732
FRI004N	117	IKU003B	157	KAL001B	568	KOF002	375	L.258-11-C	734
FRI004OS	117	IKU003BDA	157	KAL001R	568	KOF003	375	L.260-10-1	728
GEO001	481	IKU005B	157	KAL002AR	568	KOF004	375	L.260-12-4	726
GEO002	481	IKU005BDA	157	KAL002B	568	L.10-105	736	L.260-6-C	729
GEO003	481	IKU007B	157	KAL002R	568	L.10-28	736	L.263-7-DIM-B	732
GIG001	660	IKU007BDA	157	KAL003AR	568	L.10-42	736	L.264-5-RGB	732
GIG002	660	IPA001B	289	KAL003B	568	L.10-70	736	L.264-7-C-DIM	732
GIG005	660	IPA001N	289	KAL003R	568	L.11-15	736	L.264-7-C-DIM-B	732
GII001BZ	232	JAY001B	95	KAL004AR	568	L.11-25	736	L.264-7-F-DIM	732
GII001CR	232	JAY001CR	95	KAL004B	568	L.18-18	736	L.264-C-8	732
GII001CRI	232	JAY001N	95	KAL004R	568	L.18-28	736	L.264-F-30	732
GII001OR	232	JAY002B	95	KAR001NOTS	79	L.18-42	736	L.264-F-8	732
GII002N	232	JAY002CR	95	KAR002NOTS	79	L.19-28	736	L.265-7-DIM-B	732
GII002R	232	JAY002N	95	KAR003NOTS	79	L.202-12-C-LED	733	L.266-10-1	728
GII002TR	232	JUL001B	381	KAR004NOTS	81	L.202-12-F-LED	733	L.266-12-4	726
GII002V	232	JUL002B	381	KAR005NOTS	81	L.202-15-C-LED	733	L.266-6-C	729
GII003N	232	JUL003B	381	KITDEC001B	225	L.203-12-C	733	L.268-9-C	737
GII003R	232	JUL004B	381	KITDEC001CR	225	L.203-12-F	733	L.268-9-F	737

INDICE INDEX

L.269-7-2K	<b>732</b>	L.285-10-1	<b>728</b>	L.48-2	<b>728</b>	L.510-10-6K	<b>734</b>	L.927-LED	<b>729</b>
L.269-8-C	<b>732</b>	L.285-11-1	<b>729</b>	L.500-22	<b>739</b>	L.510-18-3K	<b>734</b>	L.929-11-C	<b>737</b>
L.269-8-F	<b>732</b>	L.285-12-4	<b>726</b>	L.500-32	<b>739</b>	L.510-18-4K	<b>734</b>	L.929-11-F	<b>737</b>
L.271-3,5	<b>729</b>	L.286-4-C	<b>728</b>	L.500-40	<b>739</b>	L.510-18-6K	<b>734</b>	L.929-9-C	<b>737</b>
L.272-7-2K	<b>732</b>	L.287-10-1	<b>728</b>	L.500-LED	<b>734</b>	L.510-25-3K	<b>734</b>	L.929-9-F	<b>737</b>
L.272-7-3K	<b>732</b>	L.287-12-4	<b>726</b>	L.501-18-82	<b>739</b>	L.510-25-4K	<b>734</b>	L.932-15-F	<b>737</b>
L.272-7-4K	<b>732</b>	L.289-5-AM	<b>725</b>	L.501-18-83	<b>739</b>	L.510-25-6K	<b>734</b>	L.932-20-F	<b>737</b>
L.273-5	<b>732</b>	L.289-5-FU	<b>725</b>	L.501-18-84	<b>739</b>	L.56-4-LED-C	<b>733</b>	L.932-23-C	<b>737</b>
L.273-5-2K	<b>732</b>	L.291-5	<b>724</b>	L.501-18-86	<b>739</b>	L.57-28	<b>736</b>	L.932-23-F	<b>737</b>
L.273-5-4K	<b>732</b>	L.292-5-FU	<b>724</b>	L.501-36-82	<b>739</b>	L.57-5-LED-C	<b>733</b>	L.933-20	<b>738</b>
L.274-4-F	<b>732</b>	L.292-5-GOLD	<b>724</b>	L.501-36-83	<b>739</b>	L.58-28	<b>736</b>	L.933-23	<b>738</b>
L.275-10-1	<b>733</b>	L.292-5-V	<b>724</b>	L.501-36-86	<b>739</b>	L.58-7-LED-C	<b>733</b>	L.957-9-F	<b>732</b>
L.275-10-2	<b>733</b>	L.293-5-FU	<b>724</b>	L.501-58-82	<b>739</b>	L.810-11-C	<b>737</b>	L.959-10-1	<b>728</b>
L.275-10-3	<b>733</b>	L.293-5-GOLD	<b>724</b>	L.501-58-83	<b>739</b>	L.810-11-F	<b>737</b>	L.959-11-1	<b>729</b>
L.275-11-1	<b>733</b>	L.293-5-V	<b>724</b>	L.501-58-84	<b>739</b>	L.810-13-F	<b>737</b>	L.959-12-4	<b>726</b>
L.278-10-1	<b>728</b>	L.294-5-FU	<b>725</b>	L.505-13	<b>739</b>	L.810-7-F	<b>737</b>	L.959-12-C	<b>729</b>
L.278-12-4	<b>726</b>	L.294-5-GOLD	<b>725</b>	L.505-14-83	<b>739</b>	L.8111-11-C	<b>737</b>	L.959-13-1	<b>727</b>
L.281-5-C	<b>724</b>	L.295-10-GOLD	<b>725</b>	L.505-14-84	<b>739</b>	L.8111-11-F	<b>737</b>	L.959-16-C	<b>729</b>
L.282-21-C	<b>729</b>	L.296-10-GOLD	<b>725</b>	L.505-21-83	<b>739</b>	L.8111-13-C	<b>737</b>	L.959-6-27K-WF	<b>730</b>
L.282-5-C	<b>724</b>	L.297-10-GOLD	<b>725</b>	L.505-21-84	<b>739</b>	L.8111-13-F	<b>737</b>	L.959-9-RGB	<b>729</b>
L.283-10-1	<b>728</b>	L.31-25	<b>736</b>	L.505-24-83	<b>739</b>	L.8111-15-C	<b>737</b>	L.960-15-F	<b>737</b>
L.283-11-1	<b>729</b>	L.31-40	<b>736</b>	L.505-24-84	<b>739</b>	L.8111-15-F	<b>737</b>	L.960-25-C	<b>737</b>
L.283-12-4	<b>726</b>	L.31-60	<b>736</b>	L.505-28-83	<b>739</b>	L.8113-9-F	<b>729</b>	L.960-25-F	<b>737</b>
L.283-13-1	<b>727</b>	L.320-10-1	<b>733</b>	L.505-28-84	<b>739</b>	L.811-7-C	<b>737</b>	L.961-15	<b>738</b>
L.283-5-FU	<b>726</b>	L.320-10-C-LED	<b>733</b>	L.505-35-83	<b>739</b>	L.811-7-F	<b>737</b>	L.961-20	<b>738</b>
L.283-5-V	<b>727</b>	L.320-10-F-LED	<b>733</b>	L.505-35-84	<b>739</b>	L.811-9-C	<b>737</b>	L.961-9	<b>738</b>
L.283-6-27K-WF	<b>730</b>	L.320-120	<b>735</b>	L.505-39-83	<b>739</b>	L.811-9-F	<b>737</b>	LAS001BLU	<b>592</b>
L.283-6-OP-2K	<b>729</b>	L.320-160	<b>735</b>	L.505-39-84	<b>739</b>	L.815-10-1	<b>733</b>	LAS001RO	<b>592</b>
L.284-10-1	<b>728</b>	L.320-240	<b>735</b>	L.505-54-83	<b>739</b>	L.908-15-C	<b>738</b>	LAS002BLU	<b>592</b>
L.284-11-1	<b>729</b>	L.320-400	<b>735</b>	L.505-54-84	<b>739</b>	L.908-15-F	<b>738</b>	LAS002RO	<b>592</b>
L.284-12-4	<b>726</b>	L.320-80	<b>735</b>	L.505-6	<b>739</b>	L.908-20-C	<b>738</b>	LAS003BLU	<b>593</b>
L.284-13-1	<b>727</b>	L.379-10-1	<b>733</b>	L.505-8	<b>739</b>	L.908-20-F	<b>738</b>	LAS003RO	<b>593</b>
L.284-5-FU	<b>726</b>	L.379-48	<b>735</b>	L.505-80-83	<b>739</b>	L.908-25-C	<b>738</b>	LEI001	<b>395</b>
L.284-5-V	<b>727</b>	L.379-80	<b>735</b>	L.505-80-84	<b>739</b>	L.908-25-F	<b>738</b>	LEI002	<b>395</b>
L.285-5-FU	<b>726</b>	L.379-120	<b>735</b>	L.510-10-3K	<b>734</b>	L.908-30-C	<b>738</b>	LEI003	<b>395</b>
L.285-5-V	<b>727</b>	L.379-200	<b>735</b>	L.510-10-4K	<b>734</b>	L.908-30-F	<b>738</b>	LEI004	<b>395</b>

INDICE INDEX

LEI005	395	MIE006B	365	NER001AV	421	P.3061-35	663	PIN001AN	678
LEI006	395	MIE007B	365	NER001R	421	P.3218-20	265	PIN001B	678
LEK001B	111	MIE008B	365	OBA101BLU	218	P.3218-30	265	PIN001CO	678
LEK001G	111	MIE009B	365	OBA101CRI	218	P.3400-10	503	PIN002AN	678
LEK001GR	111	MOO001B	460	OBA101FU	218	P.3400-15	503	PIN002B	678
LEK001N	111	MOO001N	460	OFU001B	283	P.3424-B	574	PIN002CO	678
LEK001R	111	MOO002B	460	OFU001N	283	P.3598-20	373	PIN010	678
LOU001B	153	MOO002N	460	OFU001NOS	283	P.3865-40	359	PLA001ARG	490
LOU001N	153	MT.31B	140	ORB001B	98	P.3867	347	PLA001OR	490
M.32-B	565	MT.31N	140	ORB001N	98	P.5488-16-B	317	PLA001SAT	490
M.32-GR	565	MT.385-B	749	ORB002B	98	P.5488-20-B	317	PLA002ARG	490
M.40-B	564	MT.385-N	749	ORB002N	98	P.5488-30-B	317	PLA002OR	490
M.40-GR	564	MT.40-B	564	ORB003B	98	P.5488-40-B	317	PLA002SAT	490
M.40-N	564	MT.40-GR	564	ORB003N	98	P.5488-40-B-LED	317	PLA003ARG	490
MAC001B	597	MT.40-N	564	P.10330-25	325	P.6187-B	451	PLA003OR	490
MAC001FU	597	MT.41-B	564	P.10330-50	325	P.6187-GR	451	PLA003SAT	490
MAC002B	597	MT.41-GR	564	P.10455-20	321	P.6188-B	451	POL001	430
MAC002FU	597	MT.41-N	564	P.10455-35	321	P.6188-GR	451	POL002	430
MEB001B	463	MT.42	564	P.10770-40-AV	415	P.8801	515	POM001	525
MEB001OT	463	MT.5001	645	P.10770-40-GR	415	P.9785-30-CR	666	POM003	525
MEB002B	463	MT.8USB	745	P.10850-20	353	P.9785-40-CR	666	POM005	525
MEB002OT	463	MT.808	697	P.10850-30	353	PAR001ARG	299	POM009	525
MEG001ALU	239	MT.ORB101B	98	P.10850-40	353	PAR001OR	299	POM011	525
MEG001AM	239	MT.ORB101N	98	P.1304-35	355	PAR002ARG	299	PON001B	186
MEG001FU	239	MT.ORB102B	98	P.1304-55	355	PAR002OR	299	PON001N	186
MEG005ALU	240	MT.ORB102N	98	P.1304-75	355	PAR003ARG	299	PON001T	186
MEG005AM	240	MT.ROS003FB	225	P.1962-25-AM	665	PAR003OR	299	PON002B	186
MEG005FU	240	MT.ROS003FCR	225	P.1962-25-B	665	PAV001	67	PON002N	186
MEL001	583	MT.ROS006FB	225	P.1962-25-N	665	PEG001B	291	PON002T	186
MET001B	717	MT.ROS006FCR	225	P.1962-25-R	665	PEG001FU	291	PON003B	186
MET001GR	717	MT.SHUWF	730	P.1962-40-AM	665	PEG001R	291	PON003N	186
MIE001B	365	MT.SWIWF	730	P.1962-40-B	665	PEG001SAT	291	PON003T	186
MIE002B	365	MYR001B	467	P.1962-40-N	665	PIA001SAT	587	PON004B	186
MIE003B	365	NEL001B	452	P.1962-40-R	665	PIA002SAT	587	PON004N	186
MIE004B	365	NEL001N	452	P.2041	624	PIC001B	287	PON004T	186
MIE005B	365	NER001AN	421	P.2064	631	PIC001N	287	PON005B	186

INDICE INDEX

PON005N	186	ROS202CR	212	SAL002B	407	SIE001N	682	T.3182-N	441
PON005T	186	ROS203CR	212	SAL002GR	407	SMO001	159	T.3182-OS	441
PON006B	186	ROY001	609	SAN001B	274	SMO001CA	159	T.3218	265
PON006N	186	ROY002	609	SAN001BLU	274	SMO001DA	159	T.3350-1	445
PON006T	186	ROY003	609	SAN001G	274	SOP001	363	T.3424-B	575
PUZ001AZ	171	RUN001B	327	SAN001R	274	SPN001B	166	T.3598	373
PUZ001B	171	RUN001CR	327	SAN002B	274	SPN001S	166	T.3865	359
PUZ001N	171	RUN001OL	327	SAN002BLU	274	SPN002B	166	T.3867	347
PUZ001R	171	RUN002B	327	SAN002G	274	SPN002S	166	T.808-22	697
REA001B	701	RUN002CR	327	SAN002R	274	SPN003B	167	T.808-38	697
REA001CR	701	RUN002OL	327	SAN003	274	SPN003S	167	T.808-55	697
REA001N	701	RUN003B	327	SAN004	274	SPN004B	167	T.809-50	697
REA002B	701	RUN003CR	327	SAN005B	275	SPN004S	167	T.809-75	697
REA002CR	701	RUN003OL	327	SAN005BLU	275	SUN001B	205	T.8817	517
REA002N	701	RUN004B	327	SAN005G	275	SUN001N	205	TAC001	425
REA003B	701	RUN004CR	327	SAN005R	275	SUN002B	205	TAC002	425
REA003CR	701	RUN004OL	327	SAY001B	703	SUN002N	205	TAE001AN	689
REA003N	701	S.10455-35	321	SAY001CR	703	SYR002	577	TAE002BLU	693
REG001	636	S.10455-50	321	SAY001OS	703	SYR005	577	TAE002G	693
REG002	636	S.10470	343	SAY002B	703	SYR006	577	TAE002KIT	693
REG003	636	S.10470-LED	343	SAY002CR	703	SYR007	577	TAE002R	693
REG004	636	S.10570-35	335	SAY002OS	703	T.10301	439	TAE002V	693
REG005	637	S.10570-45	335	SAY003B	703	T.10570	335	TAI101AZ	224
REG006	637	S.10610	378	SAY003CR	703	T.10760-AV	419	TAI101BLU	224
REG007	637	SAD001B	469	SAY003OS	703	T.10760-GR	419	TAI101CRI	224
REM001B	63	SAD001NO	469	SHE001B	257	T.10770-AV	415	TAI101FU	224
REM001OTN	63	SAD002B	469	SHE001RO	257	T.10770-GR	415	TAI102AZ	224
REM002B	63	SAD002NO	469	SHE002B	257	T.10850	353	TAI102BLU	224
REM002OTN	63	SAD003B	469	SHE002RO	257	T.1404-B	339	TAI102CRI	224
REM003B	63	SAD003NO	469	SHE003B	257	T.2133-CR	479	TAI102FU	224
REM003OTN	63	SAD004B	469	SHE003RO	257	T.2135-B	479	TAS001	329
REN001	378	SAD004NO	469	SHE004B	257	T.2135-CR	479	TAS002	329
REN002	378	SAD005B	469	SHE004RO	257	T.3061	663	TAS003	329
REN003	379	SAD005NO	469	SIE001B	682	T.3182-B	441	TER001	52
REN004	379	SAL001B	407	SIE001BLU	682	T.3182-CR	441	TER002	53
RIF001	244	SAL001GR	407	SIE001CO	682	T.3182-GR	441	TOO001	431



INDICE INDEX

TSU001NOL	87	V.608-25-BL	743	W.9510-N	748	WED003B	190
TSU002NOL	87	V.608-25-SAT	743	W.9510-OR	748	WED003T	190
TSU003NOL	87	V.608-30-BL	743	W.9510-T-B	748	WED004B	190
TUR001ORO	279	V.608-30-SAT	743	W.9510-T-N	748	WED004T	190
TUR002ORO	279	V.608-35-BL	743	W.9510-T-OR	748	WED005B	190
TWI001NOTS	71	V.608-35-SAT	743	W.9511-B	748	WED005T	190
TWI001OTS	71	V.608-40-BL	743	W.9511-N	748	WED006B	190
TWI002NOTS	71	V.608-40-SAT	743	W.9511-OR	748	WED006T	190
TWI002OTS	71	V.915-100	744	W.9511-T-B	748	WES001B	494
TWI003NOTS	71	V.915-125	744	W.9511-T-N	748	WES001GR	494
TWI003OTS	71	V.915-180	744	W.9511-T-OR	748	WES002B	494
TWI004NOTS	71	V.915-200	744	W.9512-B	748	WES002GR	494
TWI004OTS	71	V.915-230	744	W.9512-N	748	WES003B	494
TWI005NOTS	71	V.915-300	744	W.9512-OR	748	WES003GR	494
TWI005OTS	71	V.9501-20	652	W.9512-T-B	748	WES004B	494
UMA001B	405	V.9501-25	652	W.9512-T-N	748	WES004GR	494
UMA001BZ	405	V.9501-30	652	W.9512-T-OR	748	WES005B	494
UMA001N	405	VIT001	429	W.9517-B	749	WES005GR	494
V.117-CRI	735	VIT002	429	W.9517-N	749	ZIG001AZ	271
V.178-CRI	735	W.9500-B	747	W.9518-B	746	ZIG001G	271
V.509-16	743	W.9500-N	747	W.9518-N	746	ZIG001R	271
V.509-20	743	W.9500-TR	747	W.C-9504-A	748	ZIG002AZ	271
V.509-25	743	W.9502-N-LED	745	W.C-9504-B	748	ZIG002G	271
V.509-30	743	W.9502-TR-LED	745	W.C-9505-A	748	ZIG002R	271
V.509-35	743	W.9503-70	747	W.C-9505-B	748		
V.509-40	743	W.9503-85	747	W.D-28-B	749		
V.608-12-BL	743	W.9506-B	747	W.D-28-N	749		
V.608-12-SAT	743	W.9506-N	747	W.D-28-OR	749		
V.608-14-BL	743	W.9506-OR	747	W.D-9509-B	747		
V.608-14-SAT	743	W.9507-B	747	W.D-9509-N	747		
V.608-16-BL	743	W.9507-N	747	W.D-9509-OR	747		
V.608-16-SAT	743	W.9507-OR	747	WAN001	113		
V.608-18-BL	743	W.9508-B	747	WED001B	190		
V.608-18-SAT	743	W.9508-N	747	WED001T	190		
V.608-20-BL	743	W.9508-OR	747	WED002B	190		
V.608-20-SAT	743	W.9510-B	748	WED002T	190		

## LEGENDA LEGEND

	ALLUMINIO ALUMINIUM
	AMBRA AMBER
	AMARANTO REDDISH PURPLE
	ANTRACITE ANTHRACITE
	ARANCIONE ORANGE
	FOGLIA ARGENTO SILVER LEAF
	AVORIO IVORY
	AZZURRO LIGHT BLUE
	BIANCO WHITE
	BIANCO LATTE (lucido) WHITE MILK
	BLU BLUE
	BIANCO-ORO SATINATO WHITE-SATIN GOLD
	BRONZO BRONZE
	CORTEN CORTEN
	CROMO CHROME
	CRISTALLO CRYSTAL
	FUME SMOKED
	GIALLO YELLOW
	GRIGIO GREY
	LILLA LILAC
	MARRONE BROWN
	NERO BLACK
	NERO-BIANCO BLACK-WHITE
	NICHEL OPACO MATT NICKEL
	NERO-ORO LUCIDO BLACK POLISHED GOLD
	NERO-ORO SATINATO BLACK SATIN GOLD
	NERO-OTTONE SATINATO BLACK SATIN BRASS
	NICHEL SATINATO SATIN NICKEL
	ORO LUCIDO GLOSSY GOLD
	ORO GOLD
	FOGLIA ORO GOLD LEAF
	ORO SATINATO SATIN GOLD
	OTTONE BRASS
	OTTANIO TEAL
	OTTONE SATINATO SATIN BRASS
	ROSSO RED
	RAME COPPER
	ROSA PINK
	SABBIA SAND
	SATINATO SATIN

	TORTORA DOVE-GREY
	TRASPARENTE TRANSPARENT
	VIOLA PURPLE
	VERDE GREEN
	VERDE OLIVA OLIVE GREEN
	VERDE SALVIA SAGE GREEN
	WENGE' WENGE'
	ZUCCA PUMPKIN

### ABBREVIAZIONI TECNICHE TECHNICAL ABBREVIATIONS

 diametro apparecchio diameter

**F** foro hole

**G** griffa entrance

**I** imbocco entrance

 profondità depth

### CLASSI DI ISOLAMENTO E SIMBOLOGIE INSULATION CLASSES AND SYMBOLS

 apparecchio di classe I con morsetto a terra  
class I product with earth terminal

 apparecchio di classe II  
class II product

 apparecchio di classe III  
class III product

 apparecchio idoneo al montaggio su superfici  
normalmente infiammabili  
product suitable for the surfaces normally  
inflammable

### TIPOLOGIA TYPOLOGY

 PLAFONE CEILING

 SOSPENSIONE SUSPENSION

 APPLIQUE APPLIQUE

 LAMPADA DA TAVOLO TABLE LAMP

 LAMPADA DA TERRA FLOOR LAMP

### SIMBOLI DIMMERAZIONE DIMMABLE SYMBOL

 PUSH DIMMER

 TOUCH DIMMER

 TAGLIO DI FASE PHASE CUT

 VARIALUCE DIMMER

 DALI

### GRADO DI PROTEZIONE - IP INTERNATIONAL PROTECTION - IP

La "resistenza" offerta dall'apparecchio alla penetrazione di solidi e liquidi viene indicata dal prefisso IP (*International Protection*) seguita da due cifre, la prima identifica il grado di protezione contro l'ingresso dei corpi solidi e la seconda dei liquidi.

The "resistance" offered by the product to the solids and liquids penetration is indicated by the IP prefix (*International Protection*) followed by two digits, the first identifies the degree of protection against ingress of solid objects and the second liquid.

### PRIMA CIFRA / FIRST NUMBER

**0** non protetto  
unprotected

**1** protetto contro la penetrazione di corpi solidi di dimensioni superiori a 50mm  
protected against the intrusion of solid objects larger than 50mm

**2** protetto contro la penetrazione di corpi solidi di dimensioni superiori a 12mm  
protected against the intrusion of solid objects larger than 12mm

**3** protetto contro la penetrazione di corpi solidi di dimensioni superiori a 2,5mm  
protected against the intrusion of solid objects larger than 2,5mm

**4** protetto contro la penetrazione di corpi solidi di dimensioni superiori a 1mm  
protected against the intrusion of solid objects larger than 1mm

**5** protetto contro la penetrazione della polvere  
protected against dust penetration

**6** protetto completamente contro la penetrazione della polvere  
completely protected against dust penetration

### SECONDA CIFRA / SECOND NUMBER

**0** non protetto  
unprotected

**1** protetto contro le cadute verticali di gocce d'acqua  
protected against water vertically falling drops of water

**2** protetto contro la caduta dell'acqua con inclinazione massima di 15°  
protected against falling water with 15° maximum inclination

**3** protetto contro la pioggia  
protected against rain

**4** protetto contro gli spruzzi  
protected against spray-back

**5** protetto contro i getti d'acqua  
protected against the water jets





## ISPIRAZIONI CROMATICHE

Suggestive ambientazioni e accostamenti cromatici danno vita a set creativi in cui le lampade trovano nuove e sempre diverse interpretazioni.  
*by Elisa Rossini – Marketing & Communication Director*

Vi sveliamo ora l'accurato lavoro svolto con la stylist Francesca Vizzari di Pistacchio & Caffè. Per un catalogo di rottura e ambasciatore del rinnovamento aziendale, era necessario un lavoro speciale e unico. Le parole chiave sono: ambientazione, emozione e colore. La scelta è quindi ricaduta su una interior designer che ha fatto del progetto colore la sua specializzazione e la sua professione.

Un progetto frutto di ascolto e di condivisione tra la stylist e l'azienda, dove l'interpretazione delle lampade si sposa con l'ideazione di un particolare ambiente. Incontro dopo incontro, le idee si sono concretizzate in dettagliati set e ognuno porta con sé una visione, un modo di interpretare le lampade, un mood e uno stile che ora vi vogliamo raccontare.

## CHROMATIC INSPIRATIONS

Suggestive settings and color combinations give life to creative sets in which the lamps find new and always different interpretations.  
*by Elisa Rossini – Marketing & Communication Director*

We here want to tell you about the accurate job of the stylist Francesca Vizzari from Pistacchio & Caffè. As this is a new catalogue, symbol of a new era in the company and a radical change from the past, it was necessary a unique and special work. The keywords of the job were setting, emotion and colour. So we chose an interior designer that has been pursuing and working with colours as a professional.

The project was made of listening and sharing between the company and the stylist, where the ideas behind the lamps meet the creation of a particular setting. Meeting after meeting, ideas took the form of accurate locations, all with a specific vision, interpretation of the lamps, mood and style that we are now about to tell you.

# COLLECTION 9.0

---

## EASY NORDIC

Protagonisti: Fringe, Jay



Fuori imperversano il freddo e l'inverno, dentro un mood total white, che ha il sapore di una cioccolata fumante aromatizzata alla cannella, assaporata su un caldo tappeto in pelle di pecora. A far da sfondo: tronchi bianchi di betulla. Ad illuminare l'ambiente: prodotti dallo stile minimal e dalle forme semplici, ma che riscaldano il salotto con la loro luce.

Outside winter and chill prevail. Inside a total white mood, scenting of a smoking hot chocolate with cinnamon, maybe tasted over a soft sheep carpet. Birch trunks on the back. Products with minimal and simple lines warm up the living room with their light.

## TECNO OFFICE

Protagonista: iGloo



Una scanzonata sala d'attesa. Un angolo di ufficio un po' particolare, forse domestico, dove i "to do" appesi alla parete non sono minacciosi e anzi invogliano a godersi la vita. Dominano le mezze tinte e i colori soft, illuminati da un fascio netto e preciso di una luce mobile e super tecnologica.

A light-hearted waiting room. A bit peculiar office corner, perhaps domestic, where the "to dos" hanging on the wall are not threatening and rather entice one to enjoy life. Half-tones and soft colors dominate, illuminated by a clear and precise beam of a mobile and super-technological light.

## RUSTIC CHIC

Protagonisti: Pic-nic, Take away



È primavera, il momento perfetto per un pic-nic al parco o, perché no, ricreato nel proprio angolo di casa. Cuscini dalle tinte soffici e morbide, una coperta avvolgente e dei cupcakes zuccherosi al punto giusto. Il mood perfetto per la luce "prêt-à-porter" outdoor, a rischiarare le chiacchiere rilassate mollemente adagiati per terra.

It's springtime, the perfect moment for a pic-nic at the park or for setting it at your own home, why not? Soft and silky cushions, an enveloping blanket and cupcakes sugary just enough. This is the ideal mood for our outdoor "prêt-à-porter" light, perfect to light up chatters comfortably eased lying down on the floor.

## TECNO LIGHT

Protagonisti: Terrazza Martini, Crystal, Chopin



Il banco bar pullula di oggetti ed accessori: l'arte di un bartender ha bisogno di concentrazione e di dettagli. Quali migliori prodotti a LED possono illuminare il suo tavolo di lavoro, ovvero il suo palcoscenico, fornendo la luce adatta a stimolare la creatività? Il gioco con Terrazza Martini è presto fatto...

The bar counter is full of objects and tools. The bartender performance needs details and concentration. What better LED products can light up his worktable, his stage, giving the perfect light that stimulates his creativity? Terrazza Martini fits perfectly to the task...

# COLLECTION 9.0

---

## URBAN NOW

Protagonisti: Empty, Daisho



Una camera di un adolescente con le sue pareti dalle tinte forti e i contrasti accesi. Street style (art decoration by ZA – Alan Zeni), libri presenti, ma un po' trascurati e tanti sogni ancora da scrivere. Prodotti con una spruzzata di tecnologia, dalle forme non invadenti che lasciano protagonista assoluto il colore.

A teenager bedroom with strong opposing colours on the walls. Street style (art decoration by ZA – Alan Zeni), books scattered all over and partially ignored, a lot of dreams still to be told. Lamps with a pinch of technology, with minimal lines that leave the colour as the unique protagonist.

## DESIGN I LOVE YOU

Protagonisti: Riflessi, Tsuki



È uno zoo di vetro quello che vediamo o un "deserto-non deserto" ricreato nel salotto di casa? I cactus sembrano non far male con le loro spine e i riflessi della lampada da terra creano giochi di doppi e di illusioni. Dal canto suo la sospensione, che ricorda la forma di una luna, ricrea in soggiorno la notte magica e ovattata del deserto.

Is it a glass zoo or a "desert non-desert" what we see in the living room? The cactus do not seem to hurt with their thorns and the ribbons of light of the floor lamp create optical illusions and double effects. For its part the suspension, which recalls the shape of a moon, reproduces in the living room the magical and muffled night of the desert.



## OUTDOOR FEELING

Protagonisti: Pic-nic, Siesta



Una terrazza soleggiata nel mese di agosto, una sdraio a bordo piscina, protetti dalla copertura di un cappello in paglia e rinfrescati da una limonata ghiacciata. La luce da esterno che invoglia ad una "siesta" si sposta dal tavolino a terra. È ancora spenta, ma al calar del sole illuminerà delicatamente la lettura di un libro o l'orario dell'aperitivo.

A sunny terrace in august, a deck chair by the pool, protected by a straw hat and cooled by iced lemonade. The outdoor light that invites to a "siesta" can be moved from the table to the floor. It is still off, but at sunset will gently illuminate the reading of a book or the cocktail hour.

## INDUSTRIAL MOOD

Protagonisti: Fringe, Karaoke, Aisha



Siamo in un'officina meccanica. Strumenti ovunque, sia in fila ordinata sugli scaffali, che sparsi sul tavolo di lavoro. Non c'è tempo per pensare al design o a ciò che è pulito e perfetto: il padrone di casa è un biker senza tanti fronzoli. Le tinte scure e dal carattere forte vengono illuminate da fasci netti e precisi dei prodotti a LED, rischiarate dalle tonalità dei materiali in bianco e in ottone.

We are in a mechanic's workshop. Some tools are lined up tidily on the shelves, others scattered around the work table. No time and worries about design and what is neat and perfect: the shop owner is a gruff biker. Neat light beams from the LED luminaires light up the strong and dark colours of the place, softened by the clear materials of the lamps in white and brass.

# COLLECTION 9.0

---

## TRENDY TODAY

Protagonisti: Twin



Anni '30. Un angolo salotto che sembra uscito dalle atmosfere jazz del Il grande Gatsby. La serata è stata lunga, non c'è tempo di riordinare, ma solo di adagiare mollemente le scarpe e la collana di perle all'ingresso, accanto alla poltroncina in velluto. Le finiture ottonate delle lampade e la luce calda emessa dalle lampadine sono silenziose testimoni della folle nottata.

It's the 30's. We are in a living room that looks like coming out from "The Great Gatsby" jazz romantic atmosphere. The night was exhausting, there's no time to clean up the room, just to lay down the shoes and the pearl necklace at the entrance, near the velvet armchair. Silent witnesses of the long mad night are the brass luminaires and the warm light coming from the vintage lamps.

## NEW OLD TIME

Protagonisti: Bell, Curl, Shell



Siamo in una cucina, l'atmosfera è quella sonnacchiosa di un sabato mattina. Niente orari stringenti o corse dettate dal ritmo metropolitano: il tempo è scandito da un cucù dalle pile scariche che ci permette di gustarci un caffè forte e di sfogliare un giornale. Il tutto illuminato da lampade a sospensione sopra il tavolo, dalle forme sinuose e avvolgenti e le tonalità sofisticate dei colori pastello.

We are in a kitchen, the atmosphere is sleepy on a Saturday morning. No stringent schedules or rides dictated by the metropolitan rhythm: time is marked by a cuckoo clock with dead batteries that allows us to enjoy a black coffee and to read a newspaper. Everything lit by suspension lamps above the table, with sinuous and enveloping shapes and sophisticated shades of pastel colors.

**COPYRIGHT by ROSSINI ILLUMINAZIONE s.r.l.  
È VIETATA LA RIPRODUZIONE ANCHE PARZIALE DEL CATALOGO**

Nella continua ricerca di miglioramenti tecnici e funzionali, ROSSINI ILLUMINAZIONE si riserva il diritto di apportare modifiche anche sostanziali ai propri prodotti, che potranno essere effettuate senza preavviso.

Disegni, quote e colori sono da intendersi a titolo puramente indicativo e non sono impegnative per ROSSINI ILLUMINAZIONE.

ROSSINI ILLUMINAZIONE è presente su tutto il territorio italiano attraverso un'ampia rete di rivenditori. Per scoprire il negozio più vicino a te contatta uno dei nostri agenti (elenco consultabile sul sito [www.rossinigroup.it](http://www.rossinigroup.it)).

**Per vedere dal vivo tutte le novità ROSSINI vieni a trovarci presso il nostro show-room a Segrate.**

**COPYRIGHT by ROSSINI ILLUMINAZIONE s.r.l.  
THE REPRODUCTION OF THE CATALOGUE EVEN PARTIAL IS FORBIDDEN**

In the continuous search for technical and functional improvements, ROSSINI ILLUMINAZIONE reserves the right to make changes also substantial to its products without prior notice. Drawings, dimensions and colors are for illustration only and are not binding for ROSSINI ILLUMINAZIONE.

ROSSINI ILLUMINAZIONE is present throughout the Italian territory through a wide network of dealers. To find the nearest store, please contact our agents (see list on [www.rossinigroup.it](http://www.rossinigroup.it)).

**To see live all new products of ROSSINI ILLUMINAZIONE come and visit us at our showroom in Segrate.**

Concept & Art Direction	Ufficio Grafico - Ufficio Marketing e Comunicazione
Prepress & Post Production	Ufficio Grafico
Copywriter	Ufficio Marketing e Comunicazione
Technical Consultant	Ufficio Acquisti - Ufficio Tecnico
Photo	Mattia Aquila Photography <a href="mailto:info@aquilamattia.it">info@aquilamattia.it</a>
Stylist	Pistacchio & Caffè <a href="mailto:francesca@pistacchioecaffe.it">francesca@pistacchioecaffe.it</a>
Finished Printing	Settembre - September 2019

Si ringrazia Gervasoni Spa per i tavolini Log Thanks to Gervasoni Spa for Log tables



**RossiniGroup** è un'articolata realtà nel mondo dell'illuminazione. Fondata nel 1929 a Milano, quando la famiglia Rossini avvia la commercializzazione di piccoli oggetti e lampadari artistici in vetro di Murano, oggi è un Gruppo presente sul mercato nazionale ed internazionale con un'offerta trasversale e completa dedicata sia al privato che al progettista, all'installatore e al contractor.

La storica **Rossini illuminazione**, che commercializza una gamma decorativa e tecnica davvero completa per interni, esterni, casa e ufficio, con quasi 5000 articoli trattati suddivisa sui due volumi del catalogo DECO e TECH.

**Plexiform**, marchio acquisito nel 2012, è un'azienda italiana con una storia di 50 anni. Oggi è il centro produttivo di Rossini Illuminazione e la sua offerta si compone di sistemi estremamente flessibili, con alte performance luminose e un occhio sempre attento al design.

**Overlite**, il più esclusivo lighting showroom di Milano, è uno spazio vastissimo con i migliori brand dell'illuminazione di design, dove progettare le migliori soluzioni illuminotecniche per i più svariati spazi abitativi.

**RossiniGroup** is an acknowledged reality in the lighting world. Established in Milan in 1929, when the Rossini family began the marketing of small objects and artistic chandeliers in Murano glass, the group today is present in the national and international market and aims at the private client as well as the architect, the contractor or the installer.

The historical **Rossini illuminazione** markets both a decorative and an extremely complete technical range for indoor and outdoor, home and office, with nearly 5000 products on the two catalogues DECO and TECH.

**Plexiform** is an Italian company that was acquired by RossiniGroup in 2012. Today it is the productive centre of Rossini illuminazione and it has been manufacturing extremely flexible lighting systems for 50 years, with high light performance and a keen eye for design.

**Overlite**, the most exclusive lighting showroom in Milano, with the top brands in the designer lighting sector. A huge space where you can get lighting projects for the most various areas and spaces.



**ROSSINI ILLUMINAZIONE SRL**

Via Kennedy, 5 20090 Segrate (MI) - ITALY  
Tel. +39 02 2169501  
Fax +39 02 21695023

[info@rossinigroup.it](mailto:info@rossinigroup.it) - [www.rossinigroup.it](http://www.rossinigroup.it)

P.IVA IT08017160154

**FOLLOW US**

**SOCIAL** - RossiniGroup

